

/ Aquatower® Fiberglass Cooling Tower /

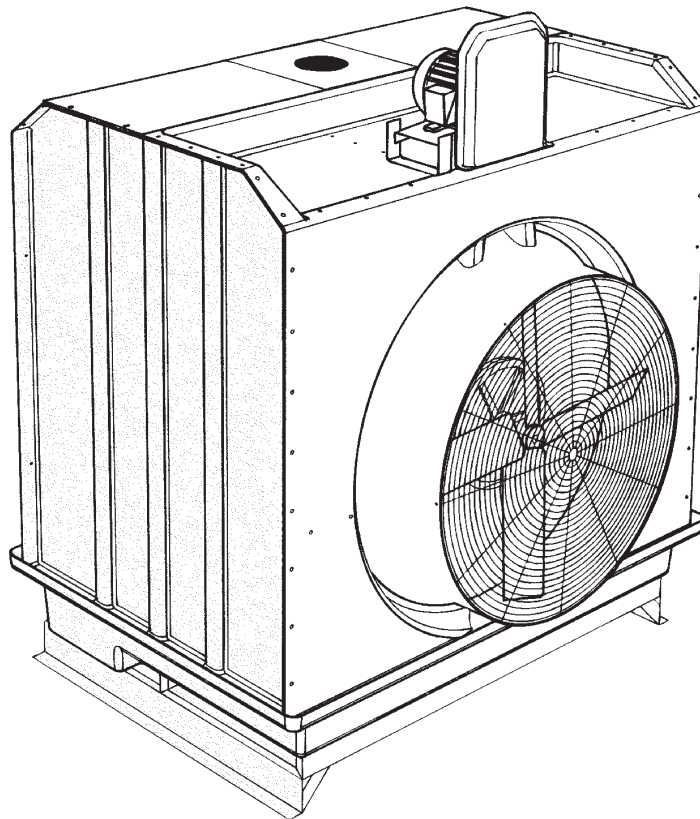

Aquatower Fiberglass Cooling Tower / Features and Benefits

2



- **Proven Performance.** CTI Certified. Plus SPX stands by its responsibility for reliable thermal performance. We designed it. ***We rate it. We guarantee it!***
- **Induced-Draft Design.** Save on fan power. The fan will operate in a warm atmosphere even in winter, so you'll never have to work on frozen mechanical equipment.
- **Architectural Compatibility.** The fiberglass Aquatower's low profile design and pleasing appearance simplify siting and minimize the need for enclosures.
- **Crossflow Design.** Save on pump power because you only pay to move the water to the top of the tower. Gravity does the rest. The mechanical equipment and water distribution system are located where you can easily maintain them.
- **All-Season Reliability.** Aquatowers perform as specified in the heat of summer. They respond well to energy management techniques in the spring and fall and with appropriate fan controls, they can operate virtually ice-free in the dead of winter. Plus they offer simple maintenance all year long.
- **Proven Corrosion Protection.** The fiberglass structure, casing, distribution basin and collection basin won't corrode, rot or decay. All steel components are G-235 galvanized steel, the most effective galvanizing used in the industry.
- **PVC Film Fill with Integral Drift Eliminators and Louvers.** If you've ever had to replace deteriorated eliminators or louvers, you'll appreciate this advantage. Integral honeycomb louvers keep the circulating water inside your tower.
- **Select Your Aquatower on our Website.** The Marley **UPDATE** web-based selection software—available at spxcooling.com/update—provides Aquatower model recommendations based on your specific design requirements
- **Simple, Flexible Installation.** Just mount the motor, belts and belt guard, install the outlet connection that suits your needs—both side suction and bottom outlet are provided, complete with screens—and adjust the float valve and your Aquatower is ready for operation.



Aquatower Fiberglass Cooling Tower / Features and Benefits

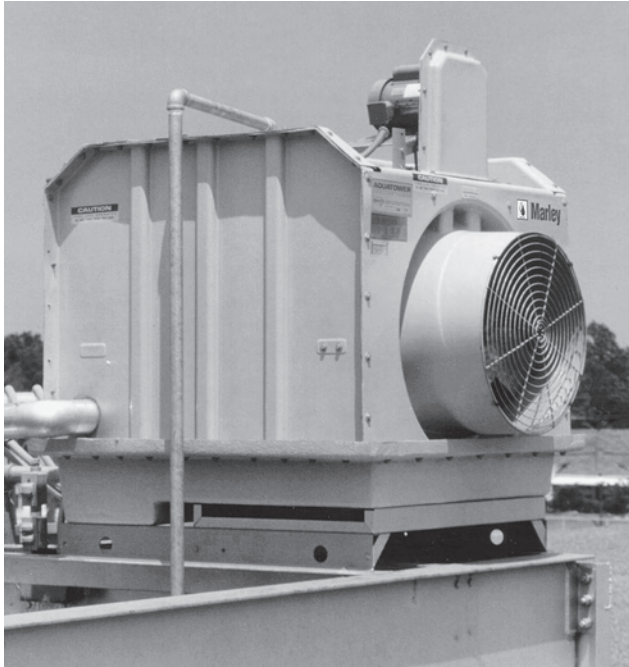

Fiberglass construction brings the classic Marley Aquatower into the 21st century. This Aquatower combines the proven cooling tower technology of the Aquatower with the proven corrosion resistance of fiberglass.

The fiberglass structure eliminates concerns about corrosion. Enjoy the benefits of fiberglass along with all the reliability you've come to expect from the long line of Aquatower models.

Today's Aquatower is considered to be the most space/energy-efficient cooling tower available. Your needs have dictated constant technological improvement. Thousands of Aquatower users enjoy the benefits of eight major redesigns and dozens of minor improvements in the past 70 years.

The fiberglass Aquatower is a maintenance delight! No hard-to-maintain rotating spray systems or tiny nozzles here! No coatings for you to maintain. Fan shaft bearing housings use durable tapered roller bearings on all models. You can easily replace and align V-belts from outside the tower.

All primary components of the Aquatower are open to view. You can easily clean the distribution basin and nozzles while the tower is in operation.

You'll enjoy single source responsibility and reliability because we design and manufacture virtually all major cooling tower components.

All Marley components are designed and selected to be a part of an integrated system. For example, the spray pattern from nozzles and the pressure drop through drift eliminators both affect a fill's heat transfer capacity. So, we include that impact in our thermal analysis. Drift eliminators must be effective at the air velocities where fill is most efficient. So, we've carefully designed both components to work together efficiently.

How many other cooling tower companies can offer you this assurance? They may use one brand of nozzle with another brand of fill and another manufacturer's drift eliminators. When they all come together, the whole may be less than the sum of the parts.

Our total system approach assures that all the parts work together to provide the most optimum performance. And because we design specifically for cooling towers, all our components will provide many years of service with minimal maintenance.

Fiberglass Aquatowers are readily available. You won't have to wait around—or accept second best—when you need a cooling tower. We maintain an impressive stock of completed towers at our own plants. A growing number of local distributors can draw from that stock.

Contact your local distributor or Marley sales representative. They'll be glad to help you choose the proper model for your needs. They can also help you with your layout and piping.

⚠ CAUTION

The cooling tower must be located at such distance and direction to avoid the possibility of contaminated discharge air being drawn into building fresh air intake ducts. The purchaser should obtain the services of a Licensed professional Engineer or Registered Architect to certify that the location of the cooling tower is in compliance with applicable air pollution, fire and clean air codes.

Aquatower Fiberglass Cooling Tower / Engineering Data: **Schematic**

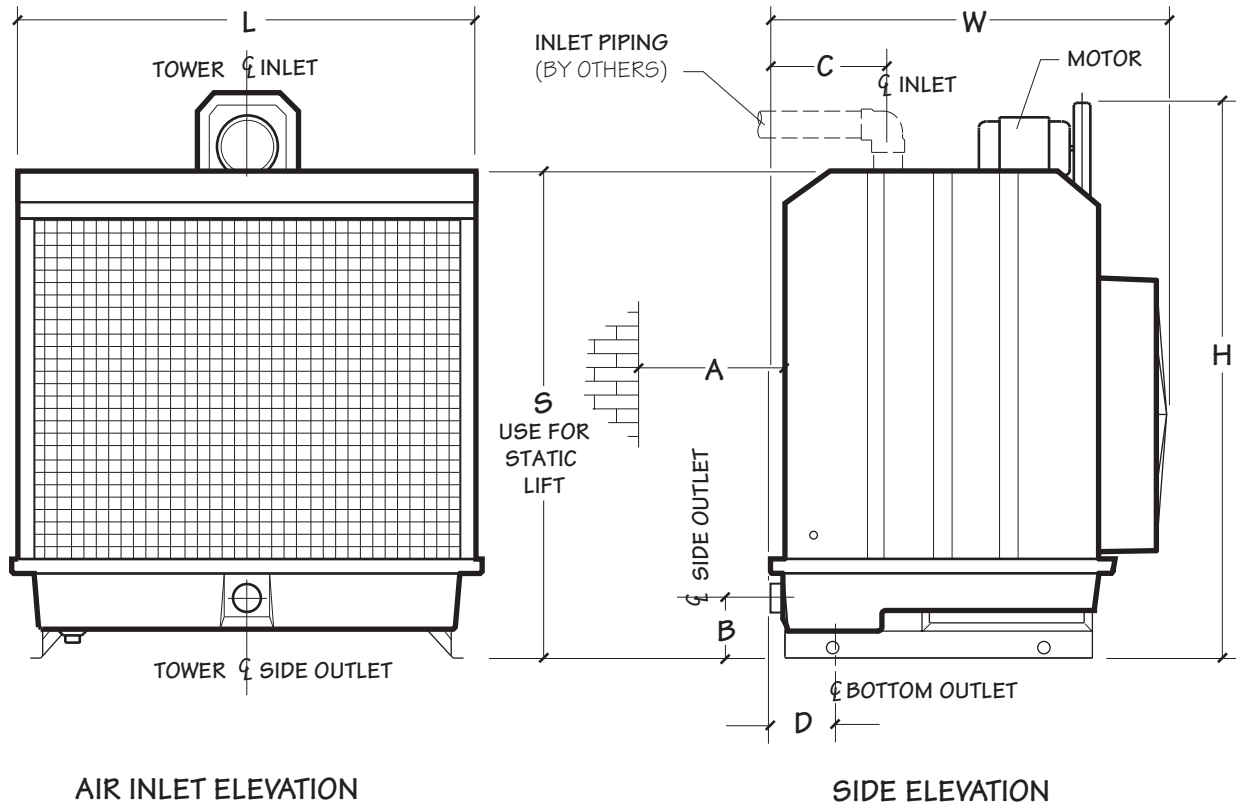

Tower Model	Nominal Tons note 1	Dimensions								Motor hp	Piping Connection	
		L	W	H	A note 2	B	C	D	S		Inlet	Outlet note 5
492D	22	4'-3"	5'-3"	7'-5 ¹ / ₁₆ "	4'-0"	9 ¹ / ₂ "	1'-6 ¹ / ₁₆ "	11"	6'-5 ⁵ / ₁₆ "	1	4"	4" M
492G	28	4'-3"	5'-3"	7'-5 ¹ / ₁₆ "	4'-0"	9 ¹ / ₂ "	1'-6 ¹ / ₁₆ "	11"	6'-5 ⁵ / ₁₆ "	2	4"	4" M
493G	36	6'-3"	5'-2 ³ / ₈ "	7'-5 ¹ / ₁₆ "	5'-0"	9 ¹ / ₂ "	1'-6 ¹ / ₁₆ "	11"	6'-5 ⁵ / ₁₆ "	2	4"	4" M
493H	42	6'-3"	5'-2 ³ / ₈ "	7'-5 ¹ / ₁₆ "	5'-0"	9 ¹ / ₂ "	1'-6 ¹ / ₁₆ "	11"	6'-5 ⁵ / ₁₆ "	3	4"	4" M
494G	51	6'-3"	6'-8 ³ / ₈ "	9'-0 ¹ / ₄ "	5'-0"	11 ¹ / ₂ "	2'-0 ⁷ / ₈ "	12 ³ / ₄ "	7'-11"	2	6"	6" MC
494H	57	6'-3"	6'-8 ³ / ₈ "	9'-0 ¹ / ₄ "	5'-0"	11 ¹ / ₂ "	2'-0 ⁷ / ₈ "	12 ³ / ₄ "	7'-11"	3	6"	6" MC
494K	68	6'-3"	6'-8 ³ / ₈ "	9'-0 ¹ / ₄ "	5'-0"	11 ¹ / ₂ "	2'-0 ⁷ / ₈ "	12 ³ / ₄ "	7'-11"	5	6"	6" MC
495K	80	8'-3"	6'-8 ³ / ₈ "	9'-0 ¹ / ₄ "	6'-0"	11 ¹ / ₂ "	2'-0 ⁷ / ₈ "	12 ³ / ₄ "	7'-11"	5	6"	6" MC
495M	91	8'-3"	6'-8 ³ / ₈ "	9'-0 ¹ / ₄ "	6'-0"	11 ¹ / ₂ "	2'-0 ⁷ / ₈ "	12 ³ / ₄ "	7'-11"	7 ¹ / ₂	6"	6" MC

- Nominal tons are based upon 95°F HW, 85°F CW, 78°F WB, and 3 GPM/Ton. The Marley **UPDATE** web-based selection software provides Aquatower model recommendations based on specific design requirements.
- Dimension **A** is the minimum clearance for adequate air supply. Consult your Marley sales representative or your local distributor if this clearance is impractical for your job.
- Motor, belt and belt guard ship uninstalled. Installation is by others.
- Inlet piping should be 4" diameter on models 492-493 and 6" diameter on models 494-495. Inlet piping should be supported independent of the tower. Inlet pipe projects through an opening in the top of the inlet box.
- Side suction outlet connection is 4" diameter NPT male thread on models 492-493 and 6" diameter with mechanical coupling groove/welding bevel on models 494-495. Bottom outlet is 6" diameter on models 492-493 and 8" on models 494-495. See page 8 for more information. Both side suction and bottom outlet are provided.
- Overflow and drain connection is 1¹/₄" diameter NPT female thread.
- Makeup connection is 3/4" diameter NPT male thread.

Aquatower Fiberglass Cooling Tower / Engineering Data: **Support Options**

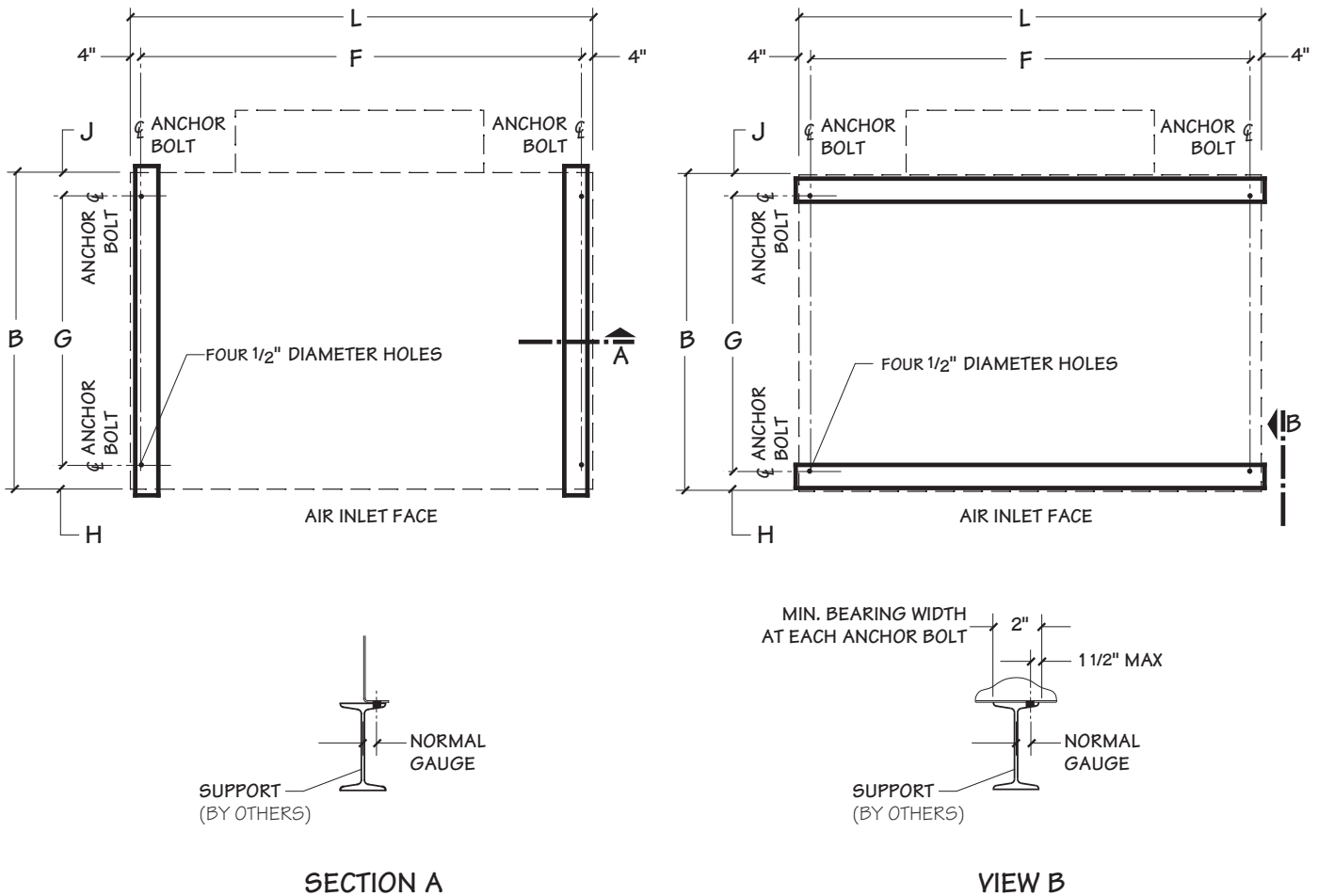

Tower Model	Dimensions						Shipping Weight lb	Maximum Operating lb	Maximum Operating Load at Anchor lb	Wind Load lb	
	L	B	F	G	H	J				Max. Vertical Reaction at Anchor	Max. Horizontal Reaction at Anchor
492	4'-3"	4'-6½"	3'-7"	3'-6"	5"	6"	497	1096	274	410	230
493	6'-3"	4'-6½"	5'-7"	3'-6"	5"	6"	637	1570	393	555	300
494	6'-3"	5'-11½"	5'-7"	5'-0"	5"	6½"	1048	2728	682	575	360
495	8'-3"	5'-11½"	7'-7"	5'-0"	5"	6½"	1313	3593	898	760	480

1. **Use this bulletin for preliminary layouts only.** Obtain current drawings from your Marley sales representative or your local distributor.
2. Purchaser to provide tower supports complete with holes and bolts for anchorage. All supports must be framed flush and level at top. Maximum deflection to be 1/360th of span, not to exceed ½".
3. Maximum weight occurs with basin full to overflow level at shutdown. Actual operating weight varies with GPM and piping scheme.
4. Wind loads are based on 30 psf and are additive to operating loads. Reactions due to wind loads exceed those resulting from seismic loads based on the 1997 UBC code, Zone 4 and an Importance Factor of 1.00 per Section 1634—Towers Not on a Building.

Use this data for preliminary layouts only. Obtain current drawing from your Marley sales representative.

UPDATE web-based selection software available at spxcooling.com/update provides Aquatower model recommendations based on customer's specific design requirements.

Aquatower Fiberglass Cooling Tower / Construction and Components

6

Water Distribution System

Warm water flows through external piping (not included with the tower) into a splash box in the distribution basin at the top of the Aquatower. This splash box helps provide uniform water distribution and keeps the incoming water from spilling out of the basin. Water then flows by gravity from the fiberglass basins through nozzles to the fill. Fiberglass basin covers are provided as standard equipment to keep the basin free from airborne debris and to reduce the likelihood of biological growth. The distribution basin is a single piece, eliminating the risk of basin leaks between adjoining panels.

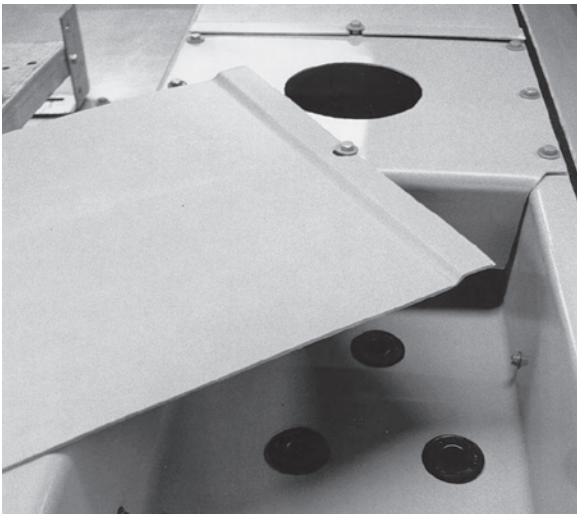

Distribution basin with cover being removed

All Aquatowers use Marley "Spiral Target" nozzles. These inert polypropylene nozzles are evenly spaced throughout the distribution basin to assure uniform water distribution over all portions of the fill. Their large openings resist clogging. Nozzles are easy to remove and replace if you ever want to change the design water flow rate.



Marley Spiral Target distribution nozzle

Fill - Louvers - Drift Eliminators

Marley MX Fill features integral louvers and drift eliminators, designed to minimize resistance to airflow. This patented arrangement prevents water from escaping the fill, assuring proper heat transfer throughout wide variations in airflow. Users find MX fill operates ice-free even in extremely cold weather.

The thermoformed 15 mil (.015) thick PVC fill sheets withstand hot water temperatures as high as 125°F. Fill sheets are immune to biological and corrosive decay and their flame spread rating is less than 25 per ASTM E-84. Galvanized structural tubes support and stabilize the fill. They also hold the bottom of the fill sheets above the cold water basin floor to simplify basin cleaning. Removable 1 x 1 mesh galvanized air inlet screens keep larger airborne trash out of the collection basin and fill area.

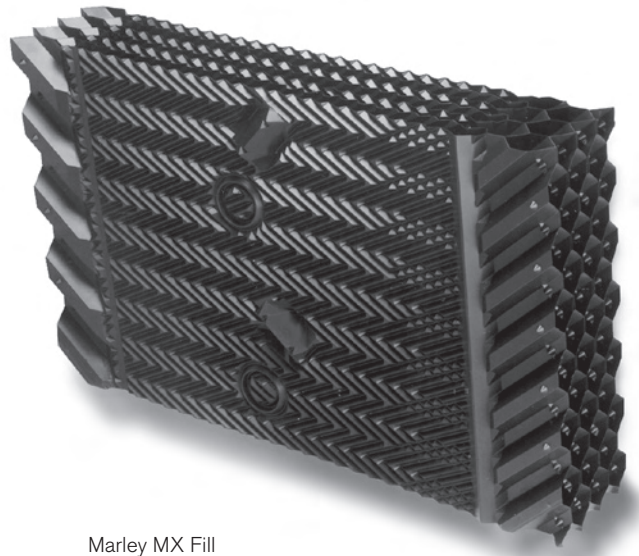

Marley MX Fill

Cold Water Collection Basin

The Aquatower's single-piece fiberglass collection basin reduces operating weight, simplifies basin cleaning and assures proper outflow. Water flows from the elevated area under the fill into the basin's rear depressed section, where side suction piping connects, or for gravity flow applications, bottom-outlet piping connects,

Standard equipment on each tower basin includes a screened side-suction connection, a threaded standpipe overflow and drain connection and a float-operated make-up valve. Mud sill and debris screen are included for gravity-flow bottom outlet connection. See page 8 for more information on outlet piping. A stainless steel cover plate is provided to seal the side-suction opening if not used.

Aquatower Fiberglass Cooling Tower / Construction and Components

■ Mechanical Equipment

Belt-drive propeller fans ensure design airflow at minimum horsepower. Fans are supported by a stainless steel fan shaft in a cast iron oil-lubricated tapered roller bearing assembly with remote oil reservoir.

Fan drive motors are TEFC designed specifically for cooling tower use. Standard motor horsepower appears in the table on page 4. Typical motor options appear on page 8.

For ease of maintenance all drive components are accessible from outside the tower.

■ Hoisting and Handling

Hoisting instructions on each tower explains how to use a spreader-bar and slings beneath the cold water basin floor to hoist the Aquatower. The tower's design also allows easy handling with a forklift.

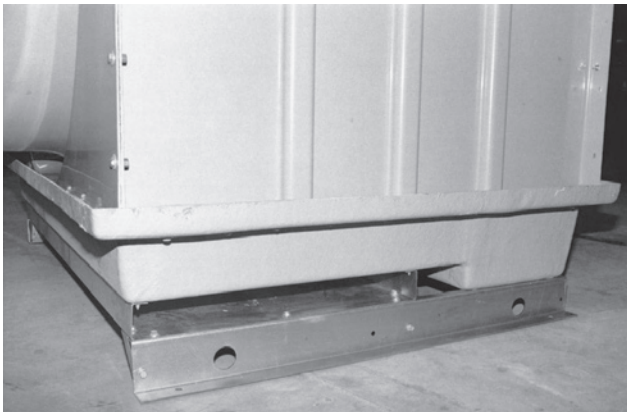

Heavy-gauge galvanized steel support assembly simplifies handling and installation

■ Safety

Aquatower safety features include fan guards and belt guards. Fan guards consist of welded heavy gauge steel wire hoops and spokes, hot dip galvanized after fabrication. The fiberglass belt guard encloses both belts and pulleys. Guards are easily removed for servicing.

■ Construction and Finish

Aquatowers offer the corrosion resistance of fiberglass reinforced polyester. All structural components, including the distribution and collection basins, casing and fan cylinder are chemically and biologically inert. Steel components on the standard tower, such as the mechanical equipment support, are G-235 galvanized—providing a zinc thickness of 2.35 oz/ft² per ASTM A-653. Assembly hardware is also galvanized. Stainless steel components are available as an option at additional cost. See page 9 for details.

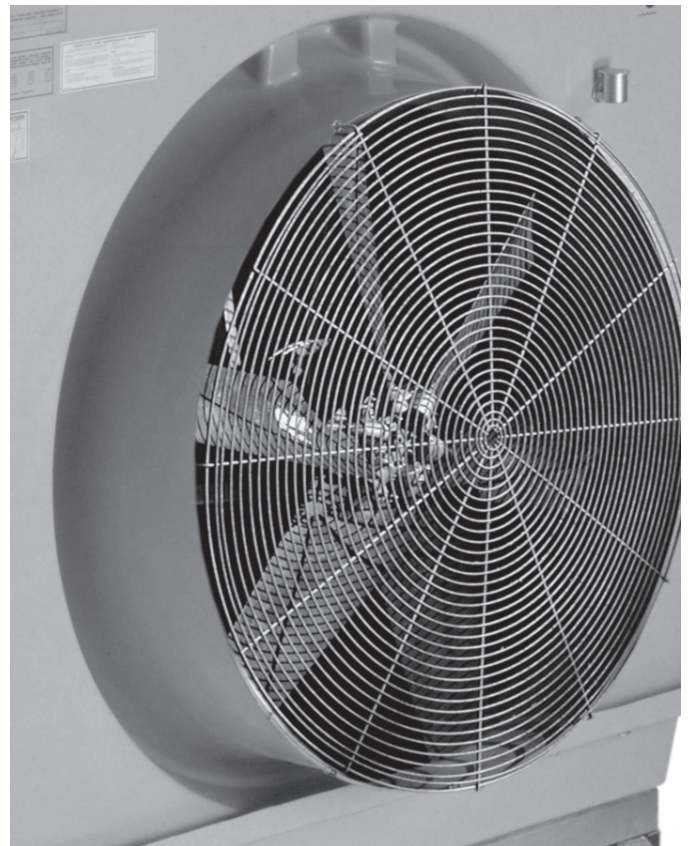

Fan and fan guard. Guard is easily removed for access to fan and drive belts



Fiberglass Aquatower Cooling Tower / Engineering Data: *Piping and Options*

■ Tower Options

Option	Description
Special Motors	200V motors are available for 1 thru 7.5 hp motors
Special Motors	Two-speed, one-wind, 460V, 60 cycle, 3 phase, TEFC motors are available for 5 and 7.5 hp motors
Field Assembly	Where unique space restrictions or rigging conditions demand, Aquatowers can be shipped ready for field assembly by others. Complete step-by-step assembly instructions are provided.
Basin Heaters	Designed to prevent basin water freezing during shutdown periods in winter operation. Unnecessary if you use an indoor tank. Heaters install easily in the field. See page 10 for complete description.

Option	Description
Stainless Steel	All assembly hardware and internal steel components are available in stainless steel. See the complete description of this option on page 9.
Control System	Factory-installed controls in NEMA 3R enclosure mounted on the tower. Includes thermostat controller for single or two-speed motors to maintain chosen cold water temperature.

■ Designed In Piping Flexibility

Since many Aquatowers are selected to serve process cooling or other applications that call for the cold water to drain from the tower by gravity flow to a remote sump, every Aquatower gives you the flexibility of piping to either the side suction (if the tower is to be hard-piped to a pump suction), or to a bottom outlet, which will allow the tower to drain completely into a remote sump for freeze protection.

Install either the standard screened suction with the hardware provided or, if you prefer gravity flow, simply discard the suction, covering the hole with the stainless steel plate provided, and use the mud sill plate as a template to cut the outlet and bolt holes. Locate to suit. Detailed instructions are provided. Outlet diameters of the various Aquatower models are shown in the following table.

Outlet Diameters		
Tower Model	Side Suction	Bottom Outlet
492 - 493	4" NPT	6"
494 - 495	6"	8"

Side outlet connection on 492-493 models is a 4" diameter male thread connection and on the larger towers a 6" diameter connection with welding bevel and mechanical coupling groove. Bottom outlet and bolt circle dimensions conform to 125# ANSI flange specifications.

Fiberglass Aquatower Cooling Tower / Engineering Data: Piping and Options

■ **Stainless Steel Option**

Inherently corrosion-proof fiberglass is the primary construction material. A few components are galvanized steel as dictated by design considerations or manufacturing economics. These components benefit from the same proven corrosion protection used on all steel Marley Aquatowers. Structural and formed steel components employ G-235 galvanizing, the heaviest galvanizing used in the industry. Assembly hardware is also galvanized to assure long service life in most atmospheres.

For those steel components which contact the circulating water, corrosive or atmospheric conditions may demand the additional corrosion resistance of stainless steel. For these applications, all assembly hardware and internal steel components are available in stainless steel. The stainless hardware option defined on page 9 includes all internal and external assembly hardware, mechanical equipment supports, fill supports, and all distribution and collection basin accessories.

On all towers, the supporting steel members, air inlet screen and fan guard remain galvanized steel. These external, heavy-gauge components provide long service life even in corrosive atmospheres. The supporting steel is G-235 galvanized, and completely removed from the water circulating on the cooling tower. The air inlet screen and fan guard are heavy-gauge welded wire, hot-dipped galvanized after welding in accordance with ASTM A-123. Heavy galvanizing assures that these components will stand up to years of use and exposure.

■ **Field Assembly**

If you choose to assemble your Aquatower at the job site, your Aquatower can be shipped unassembled with complete assembly instructions.

The adjacent table shows the sizes and weights of the largest Aquatower components for each model. You can use this information to plan your rigging and transportation needs.

Unassembled tower shipment may add 3 to 5 weeks to normal lead times. Your Marley sales representative will be glad to help you plan for your unique needs.

Component Sizes and Weights			
Tower Model	Component	Size inches	Weight lb
492	Collection Basin	12 x 51 x 55	32
	Front Panel	14 x 49 x 59	30
	Side Casing	3 x 50 x 64	30
	Distribution Basin	7 x 43 x 49	22
493	Collection Basin	12 x 55 x 75	44
	Front Panel	14 x 59 x 73	40
	Side Casing	3 x 50 x 64	30
	Distribution Basin	7 x 43 x 73	31
494	Collection Basin	15 x 72 x 75	80
	Front Panel	16 x 72 x 73	50
	Side Casing	3 x 67 x 77	50
	Distribution Basin	7 x 60 x 73	40
495	Collection Basin	15 x 72 x 99	100
	Front Panel	16 x 72 x 97	60
	Side Casing	3 x 67 x 77	50
	Distribution Basin	7 x 60 x 97	50

Aquatower Fiberglass Cooling Tower / Engineering Data: Freeze Prevention

When the ambient air temperature falls below 32°F, the water in a cooling tower can freeze. *Marley Technical Report #H-003 "Operating Cooling Towers in Freezing Weather"* describes how to prevent freezing during operation. Ask your Marley sales representative for a copy or download from our website.

Water collects in the cold water basin during shutdowns, and may freeze solid. You can prevent freezing by adding heat to the water left in the tower. Or, you can drain the tower and all exposed piping at shutdown.

■ Electric Basin Heaters

The Marley automatic basin heater system, consisting of a single-phase, 120V, 1.5 kW tank-type heater is mounted on a stainless steel plate in the depressed section of the collection basin. An internal thermostat maintains water temperature about 40°F and acts as a safety shut-off in case the water level drops below the heating element. The following table shows the required number of heaters per tower.

Quantity of 1.5kW Heaters Required							
Tower Model	Ambient Temperature °F						
	+30°	+20°	+10°	0°	-10°	-20°	-30°
492	1	1	1	1	1	*	*
493	1	1	1	2	2	2	2
494	1	1	2	2	*	*	*
495	1	2	2	3	3	4	4
* Required number of heaters will not fit basin Use indoor tank or other alternative method.							

Any exposed piping that is still filled with water at shutdown (including the makeup water line) should be electrically traced and insulated (by others).

■ Indoor Tank Method

With this system, water flows from an indoor tank, through the load system, and back to the tower, where it is cooled. The cooled water flows by gravity from the tower to the tank located in a heated space. At shutdown, all exposed water drains into the tank, where it is safe from freezing.

The adjacent table lists typical drain-down capacities. Although we do not produce tanks, many of our representatives offer tanks supplied by reputable manufacturers.

Maximum Bottom Outlet GPM				
Tower Model	Outlet Diameter			
	4"	6"	8"	10"
492	120	225	225	
493	120	270	350	
494	140	310	550	625
495	140	310	550	850

Note: Maximum GPM applies to both pump and gravity flow piping systems. The outlet piping on gravity flow systems must have sufficient vertical drop to overcome all other head losses in the system

The amount of water needed to successfully operate the system depends on the tower size, GPM and the volume of water contained in the piping system to and from the tower. You must select a tank large enough to contain those combined volumes—plus a level sufficient to maintain a flooded suction on your pump. Control makeup water according to the level where the tank stabilizes during operation.

You should always use a bottom outlet for this type of piping system. The following table lists the flow capacities for bottom outlets.

Drain-Down Capacity		
Tower Model	Range of Tower Design GPM	Maximum Drain-Down gallons
492	21 - 45	47
	46 - 92	53
	93 - 151	59
	152 - 212	64
493	33 - 71	73
	72 - 144	82
	145 - 238	91
	239 - 328	99
494	60 - 94	127
	95 - 141	134
	142 - 227	146
	228 - 376	162
495	377 - 562	178
	82 - 128	172
	129 - 192	182
	193 - 309	198
	310 - 513	200
	514 - 762	242

Aquatower Fiberglass Cooling Tower / Specifications

Base: Furnish and install an induced-draft, crossflow, factory-assembled, fiberglass cooling tower of ____ cell(s), as shown on plans. Tower shall be similar and equal in all respects to Marley Aquatower, Model _____. Tower must be warranted by the manufacturer for one year from date of shipment.

Performance: Tower shall cool ____ GPM of water from ____ °F to ____ °F at a design entering air wet-bulb temperature of ____ °F and its thermal rating shall be certified by the Cooling Technology Institute.

Construction: Structural components of the tower, including the cold water basin, framework, casing, hot water basin and fan cylinder shall be fabricated of fiber reinforced polyester. Steel components, including the mechanical equipment support members, shall be heavy gauge steel, protected against corrosion by G-235 galvanizing per ASTM-A-653. All components subjected to factory welding shall be hot-dip galvanized after fabrication per ASTM A-123. Cold galvanizing is not acceptable.

Motor: Motor(s) shall be ____ hp, Totally Enclosed, specially insulated for cooling tower duty. Speed and electrical characteristics shall be 1800 (or 1800/900) RPM, single-winding, ____ phase, ____ hertz, ____ volts. The motor must be located out of the saturated discharge air stream.

Mechanical Equipment: Fan(s) shall be adjustable-pitch propeller type. Fan shall be driven through V-belt(s) with a minimum service factor of 1.5 based on full motor hp and protected with a belt guard. The fan and fan pulley shall be supported by a stainless steel fan shaft in a cast iron oil-lubricated tapered roller bearing assembly with externally accessible remote oil reservoir for easy maintenance.

Fill, Louvers and Drift Eliminator: Fill shall be film-type, thermoformed PVC, with louvers and drift eliminator formed as part of each fill sheet. Fill shall be suspended from hot dip galvanized structural tubing supported from the upper tower structure, and shall be elevated above the floor of the cold water basin to facilitate cleaning. Air inlet faces of the tower shall be free of water splash-out. Guaranteed drift losses shall not exceed 0.005% of the design GPM.

Hot Water Distribution System: An open basin above the fill section shall receive hot water piped to each cell of the tower. This basin shall be an integral portion of the top section of the tower, precluding the need for installation and sealing. Water shall enter the basin through a removable wave-suppressor splash box. The basin shall be no less than 6 1/2" deep to provide adequate freeboard against overflow and splash-out. Removable and replaceable polypropylene nozzles installed in the floor of the basin shall provide full coverage of the fill by gravity flow. Nozzles must all have the same orifice size and be spaced symmetrically in both longitudinal and transverse direction. Removable fiberglass covers for the distribution basin are required.

Cold Water Basin and Accessories: The cold water basin shall be a single piece, joined to the tower structure at the factory. For maximum installation flexibility, basin accessories shall include both a side suction connection and, for gravity flow, provisions for a hole and bolt circle in the basin floor. Both connections shall include a debris screen and anti-cavitation device. A factory-installed, float-operated, mechanical makeup valve shall be included, having a 3/4" diameter inlet connection. The overflow shall consist of a 1 1/4" diameter PVC standpipe. When unscrewed from its fitting, this shall serve as a flush-out drain.