

Shanklin[®] Triumph

Form-Fill-Seal Wrapper

Speed, Flexibility, and High Performance
An Outstanding Value in a Sleek, Feature-Packed Design



Shanklin® Triumph Form-Fill-Seal Wrapper

Able to Receive Randomly Presented Products and Generate Product Spacing *on the Fly!*

The Shanklin Triumph® automatic form-fill-seal wrapper is a perfect midrange solution for all those applications that require more advanced features than an L-Sealer, but not quite as complex as those on a High-Speed Automatic Wrapper. Packed with a huge list of standard features, very affordably priced, and proudly made in the USA, the Shanklin Triumph is easily one of the best shrink packaging values available on the market today.

- **Flexible** – Generates product spacing on the fly from randomly presented products (fixed or random length).
- **Fast** – Can process up to 60 packages per minute.

- **Versatile** – Maintains the right-to-left product flow direction of the L-Sealer, but can be operated from either side.
- **Easy Setup** – Product changeover facilitated by digital readouts and up to 25 package parameter recipes.
- **Easy to Use** – Fully automatic operation; user-friendly touch-screen interface; reduced operator training time.
- **Compact** – Drop-in replacement for most L-Sealers (footprint approx. 5 x 8 feet).
- **Reduced Downtime** – On-board diagnostics, plug and play/modular construction.

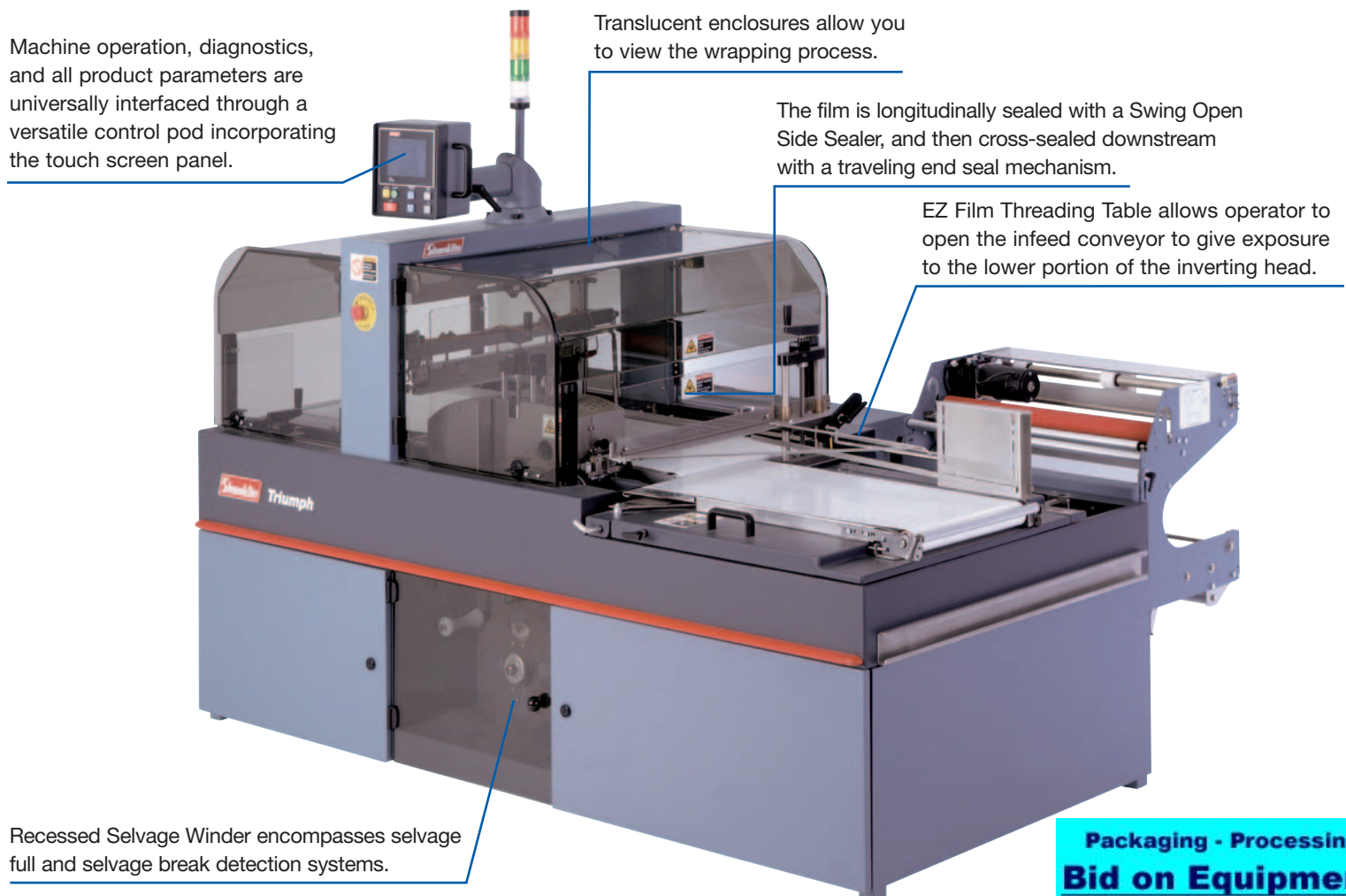

Meet Our Newest Automatic Form-Fill-Seal Wrapper

- **Control Pod with 6" Touch Color Screen Control Panel** – Multifunctional unit includes controls for speed, jaw temperatures, side seal temperatures, stop, start, slow run, spacing, dwell, diagnostics and much more. Can store all parameters for up to 25 product/film recipes.
- **Swing Arm Controls** – Facilitates operator interface access around the perimeter of the machine. The panel also tilts for viewing angle adjustments.
- **EZ Load Unwind** – Allows for easy loading and changeover of rolls of film.
- **General Purpose Pin Perforator** – Convenient, modular and easily adjustable to optimize air evacuation.
- **Quick Disconnect Electrical Sensors** – Featuring LED telltale connectors with quick disconnect plugs to aid in troubleshooting and maintenance.
- **Recessed Selvage Winder** – Places the selvage removal process conveniently within the structure of the machine.
- **Digital Adjustment Indicators** – Manual package adjustments utilize digital indicator displays to allow for repeatability and quick set up.
- **Swing-Out Electrical Box** – Provides easy access to critical areas of the machine.
- **Light Post Indicator** – Standard post indicates important machine status (stop, ready, run mode, and need for attention).
- **AC Drive Motors** – Dependable and reliable.
- **Product Changeover Versatility** – Easy adjustments for: inverting head, end seal height, side seal height, infeed conveyor, and package guides.
- **EZ Film Threading** – Allows operator to slide open the infeed conveyor to give access to the lower portion of the inverting head.
- **Swing Open Side Sealer** – Side sealer swings open for easy access to the sealing wires for cleaning or service.
- **Selvage Full Alarm** – Indicates on light post and stops machine after a short delay.
- **Selvage Break Alarm** – Stops machine and indicates on light post upon occurrence.

Standard Value-Added Features



Control Pod with 6" Touch Color Screen Control Panel



Swing Arm Controls

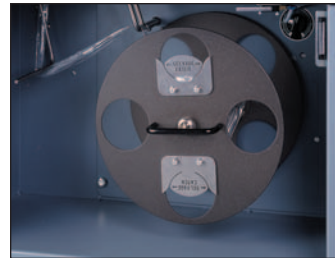

Recessed Selvage Winder with Full and Break Alarms

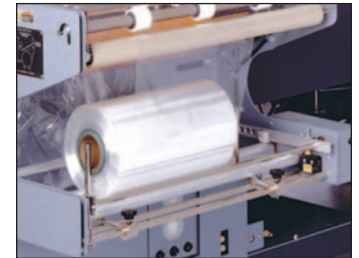

EZ Load Unwind with Pin Perforator

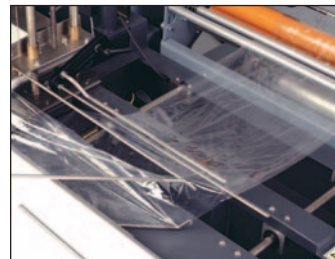

EZ Film Threading

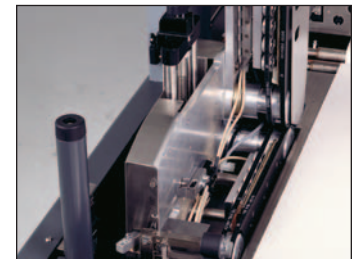

Swing Open Side Sealer

Maximum Accessibility

- The Triumph is designed for maximum accessibility for easy cleaning, troubleshooting and maintenance.

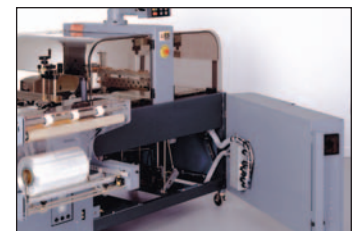

Shanklin® Triumph

Shanklin Triumph Specifications

| | Triumph |
|--------------------|---|
| Package size | Minimum 2"W x 1/8"H x 3"L Maximum 15"W x 5"H x 48"L* (Width + height combination cannot exceed 17") |
| Maximum film width | 21" folded or 42" flat (centerfolder required for flat film) |
| Conveyor height | 32 1/2" min. to 40 1/2" max. |
| Package speeds | Up to 60 jaw cycles per minute; dependent on product and application |
| Film speeds | 60 linear feet per minute |
| Longitude seal | Weld bead at side of package |
| Transverse seal | Wide fin hot knife jaws |
| Main drive | 1/2 HP AC motor with AC inverter variable speed drive |
| Power | 230 volts, 20 amps, 1 phase |
| Compressed air | 3 C.F.M. free air @ 70 psi |
| Safety devices | Emergency stops, seal jaw safety switches, protective guards, and safety interlocks on all access panels |
| Accessories | <ul style="list-style-type: none"> • EZ Load Compact Centerfolder • Dual Roll Compact Centerfolder • Flight Bar Infeed Conveyor • Flight Lug Infeed Conveyor • Casters • Print Registration |

*Product length can be extended when appropriate supporting infeed and discharge conveyors are supplied.

U.S. Patent Nos. R30,010; 4,219,988; 4,339,093; 4,419,855; 5,097,939; 5,131,213; 5,321,230; and pending. Specifications on all machines subject to change without notice. Some photos may show accessories not part of the basic machine.

The Perfect Partner

Partner your Triumph wrapper with a Shanklin Model T-71 High-Speed Shrink Tunnel for a complete, dependable, quality shrink packaging solution.



T-71

Triumph

Triumph Plan View

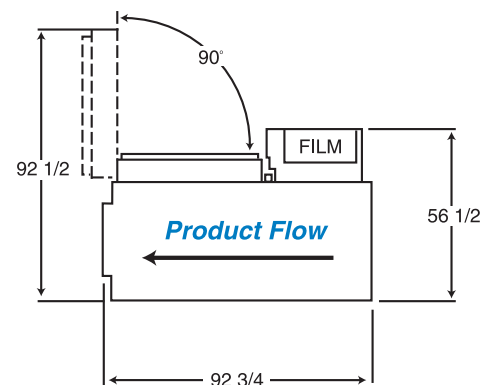

Sealed Air

Shrink Packaging
 100 Westford Road
 Ayer, MA 01432
 978-772-3200 Fax: 978-772-5660
www.shanklincorp.com

Our Products Protect Your Products®

Corporate Office: Sealed Air Corporation
 200 Riverfront Boulevard, Elmwood Park, NJ 07407 USA www.sealedair.com
 © Reg. U.S. Pat. & TMOff. © Sealed Air Corporation (US) 2008. All rights reserved. Printed in the U.S.A. The "9 Dot Logo" and "Sealed Air" are registered trademarks of Sealed Air Corporation (US).

rev 3/3/08