



“S” Applicator Print Engines



Operator and Technical Reference Manual

M-8459S, M-8460S, M-8485S, M-8490S

PREFACE

M-8485S OPERATOR'S MANUAL

The Operator's Manual for the "S" Print Engine Family contains basic information about the printer such as setup, installation, cleaning and maintenance. It also contains complete instructions on how to use the operator panel to configure the printer. The following is a brief description of each section in this manual.

SECTION 1. PRINTER OVERVIEW

This section contains a discussion of the printer specifications and optional features.

SECTION 2. INSTALLATION AND CONFIGURATION

This section contains instructions on how to unpack and set up the printer and load the labels and ribbon.

SECTION 3. CONFIGURATION

This section contains information on using the operator panel and switch panels to configure the printer.

SECTION 4. CLEANING AND MAINTENANCE

This section contains instructions on how to clean and maintain the printer.

SECTION 5. PROGRAMMING

This section introduces the "S" printer programming language. It contains the commands that are used with the printer to produce labels with bar codes, alphanumeric data and graphics.

SECTION 6. INTERFACE SPECIFICATIONS

This section contains the printer's interface specifications, which include detailed information on how to properly interface your printer to the host system.

SECTION 7. TROUBLESHOOTING

This section contains troubleshooting procedures to follow in the event you have printer problems.

APPENDICES

- APPENDIX A: Command Code Quick Reference
- APPENDIX B: Bar Code Specifications
- APPENDIX C: Custom Characters and Graphics
- APPENDIX D: Optional Accessories
- APPENDIX E: Custom Protocol Command Codes

TABLE OF CONTENTS

SECTION 1. PRINTER OVERVIEW

Introduction	1-1
Specifications	1-2
Optional Accessories	1-7

SECTION 2. INSTALLATION

Introduction	2-1
Dimensions	2-2
Component Names	2-3
Rear Panel	2-4
Sensors and Switches	2-5
Media Loading	2-6
Loading Ribbon	2-6
Loading Label Stock	2-7
Adjusting the Label Sensor	2-9
Operator Panel	2-11
Dip Switch Panel	2-12

SECTION 3. CONFIGURATION

DIP Switch Panel	3-1
Printer Adjustments (LCD Panel)	3-5
Normal Mode	3-7
User Mode	3-7
Print Darkness	3-7
Print Speed Adjustment	3-8
Pitch Offset and Direction	3-8
Cancel Print Job	3-9
Advanced Mode Settings and Adjustments	3-10
Zero slash Setting	3-10
Auto Online Setting	3-10
Vertical Offset Setting	3-10
Horizontal Offset and Direction	3-11
Sensor Threshold Level	3-13
Calendar Set	3-15
Reset Counters	3-16
Exit Mode	3-16
User Test Print	3-16
Hex Dump Diagnostic Labels	3-23
Display Counter Values	3-23

SECTION 3. CLEANING AND MAINTENANCE

Introduction	3-1
Adjusting the Print Quality	3-1
Cleaning the Print Head, Platen and Rollers	3-2
Replacing the Print Head	3-3
Cleaning the Sensors	3-4
Replacing the Fuse	3-4

SECTION 4. PROGRAMMING

Introduction	5-1
The SATO Programming Language	5-1
Selecting Protocol Control Codes	5-2
Using Basic	5-2
The M-8485S Print Area	5-4
Rotated Fields	5-7
Command Default Settings	5-8
Command Code Page Reference	5-9
Bar Codes	5-11
Bar Codes, Expansion	5-16
Bar Codes, Variable Ratio	5-17
Base Reference Point	5-19
Characters, Custom Designed	5-21
Character Expansion	5-23
Character, Fixed Spacing	5-25
Character Pitch	5-26
Character, Proportional Spacing	5-28
Clear Printer Memory and Buffers	5-29
Continuous Forms Printing	5-30
Copy Image Area	5-31
Fonts, U, S, M, OA, OB, XU, XS and XM	5-33
Fonts, Vector	5-35
Fonts, WB,WL, XB and XL	5-37
Form Feed	5-39
Form Overlay Recall	5-40
Form Overlay Store	5-41
Graphics, Custom	5-42
Graphics, PCX	5-44
Job ID Store	5-45
Journal Print	5-46
Lines and Boxes	5-47
Line Feed	5-49
Off-Line/Pause	5-50
Postnet	5-51
Print Darkness	5-52
Print Length, Expanded	5-53
Print Position	5-55
Print Quantity	5-57
Print Speed	5-58

Repeat Label	5-59
Replace Data (Partial Edit)	5-60
Reverse Image	5-62
Rotate, Fixed Base Reference Point	5-66
Rotate, Moving Base Reference Point	5-64
Sequential Numbering	5-68
Start/Stop Label	5-70
Calendar Option Commands	5-71
Calendar Increment	5-72
Calendar Print	5-74
Calendar Set	5-76
Memory Card Option Commands	5-77
Clear Card Memory	5-78
Expand Memory Area	5-79
Fonts, TrueType Recall	5-81
Fonts, TrueType Store	5-82
Format/Field Recall	5-83
Format/Field Store	5-84
Graphics, Custom Recall	5-85
Graphics, Custom Store	5-86
Graphics, PCX Recall	5-88
Graphics, PCX Store	5-89
Initialize	5-90
Slot Select	5-91
Status	5-92
Custom Protocol Command Codes Download	5-93
Two-Dimensional Symbols	5-95
Data Matrix, Data Format	5-96
Data Matrix, Print Data	5-98
Dat Matrix, Sequential Numbering	5-99
Maxicode	5-101
PDF417	5-103

SECTION 5. INTERFACE SPECIFICATIONS

Introduction	6-1
Interface Types	6-1
The Receive Buffer	6-1
Single Job Buffer	6-2
Multi Job Buffer	6-2
RS232C Serial Interface	6-3
General Specifications	6-3
Electrical Specifications	6-3
Pin Assignments	6-4
Ready/Busy Flow Control	6-4
X-On/X-Off Flow Control	6-5
Bi-Directional Communications	6-6
Centronics Parallel Interface	6-9
Electrical Specifications	6-9
Accessory (EXT) Connector	6-10
Pin Assignments	6-10
External Output Signals	6-11

SECTION 6. TROUBLESHOOTING

Initial Checklist	7-1
Using the Centronics (Parallel) Interface	7-1
Using the RS232C (Serial) Interface	7-3
Error Signals	7-4

APPENDICES

APPENDIX A: Command Code Quick Reference

APPENDIX B: Bar Code Specifications

Bar Code Symbolologies	B-1
Codabar	B-2
Code 39	B-3
Interleaved Two of Five (I 2/5)	B-4
UPC-A/EAN-13	B-5
EAN-8	B-6
Industrial Two of Five	B-8
Matrix Two of Five	B-9
Code 128	B-10
MSI	B-11
Code 93	B-12
UPC-E	B-13
Bookland (UPC/EAN Supplements)	B-14
UCC-128	B-15
Postnet	B-17
Data Matrix	B-18
Maxicode	B-20
PDF417	B-21
Code 128 Character Table	B-22

APPENDIX C: Custom Characters and Graphics

Custom Designed Character Example	C-1
Custom Graphics Example	C-4
PCX Graphics Example	C-8

APPENDIX D: Optional Accessories

PCMCIA Memory Cards	D-1
Calendar	D-2
Top Mounted Reflective Sensor	D-3

APPENDIX E: Custom Protocol Command Codes

Description	E-1
Download Command Structure	E-1
Reset	E-2
Download Procedure	E-2

SECTION 1. PRINTER OVERVIEW

INTRODUCTION

The SATO "S" Print Engines are designed to be integrated into high-performance on-site labeling systems. All printer parameters are user programmable using the front panel controls and the DIP switches. All popular bar codes and 13 human-readable fonts, including a vector font, are resident in memory providing literally thousands of type styles and sizes.

The Operator's Manual will help you understand the basic operations of the printer such as setup, installation, configuration, cleaning and maintenance.

The following information is presented in this section:

- General Printer Specifications
- Optional Accessories

SPECIFICATIONS

SPECIFICATION	M-8485S	M-8460S	M-8490S	M-8459S
PRINT				
Method	Direct or Thermal Transfer			Direct Only
Speed (User Selectable)	4 to 10 ips 100 to 250 mm/s	4 to 8 ips 100 to 200 mm/s	4 to 8 ips 100 to 200 mm/s	2 to 5 ips 50 to 125 mm/s
Print Module (Dot Size)	.0049 in. .125 mm		.0033 in. .083 mm	.0049 in. .125 mm
Resolution	203 dpi 8 dpmm		305 dpi 12 dpmm	203 dpi 8 dpmm
Maximum Print Width	5.0 in. 128 mm 1024 dots	6.0 in. 152 mm 1216 dots	4.4 in. 112 mm 1344 dots	4.4 in. 112 mm 896 dots
Maximum Print Length Expanded Print Length	7 in. (178) mm 14 in. (356) mm			
Maximum Print Length with 2MB Memory Card	49.2 in. 1249 mm		32.8 in. 833 mm	49.2 in. 1249 mm
MEDIA				
Minimum Width	1.0 in. (25 mm)	2.0 in. (53 mm)	1.0 in. (25 mm)	1.0 in. (25 mm)
Minimum Length ⁽¹⁾	.25 in. (6 mm)	.25 in. (6 mm)	.25 in. (6 mm)	.25 in. (6 mm)
Maximum Width	5.25 in 134 mm	6.5 in. 165 mm	5.25 in. 134 mm	5.25 in 134 mm
Type	Die Cut Labels, Fan-Fold or Continuous			
Maximum Caliper	.010 in. (.25 mm)			
Max Unwind torque	8.8 lbs (4 Kg) with 5 in. wide labels			
Backing Paper Rewind Tension	400 g or less			
LABEL SENSING				
See-Thru for labels or tags	Adjustable			
Reflective Eye-Mark	Fixed			
RIBBON				
Maximum Width	5.25 in. 134 mm	6.5 in. 165 mm	5.25 in. 134 mm	N/A
Length	1968 ft (600 M)			N/A
Thickness	4.5 micron, Face-In Wind			N/A

All specifications subject to change without notice.

(1) Minimum label length at print speeds greater than 6 ips is 1.0 in.

SPECIFICATION	ALL
CONTROLS AND SIGNALS	
On-Line	LED
Power	LED
Label	LED
Ribbon (Not used on M-8459S)	LED
Error	LED
LCD Panel	2 Line x 16 Character
On/Off-Line Switch	Front Panel
Label Feed Switch	Front Panel
Power On/Off Switch	Front Panel
POTENTIOMETER ADJUSTMENTS	
Print Darkness	Inside Panel
Pitch	Inside Panel
Offset	Inside Panel
Display	Front Panel
INTERFACE CONNECTIONS	
Parallel	Centronics Compatible Standard
Serial	RS232C (2400 to 19.2K bps) Standard RS422/485 (2400 to 19.2K bps) Optional
Serial Protocol	Hardware Flow Control (Ready/Busy) Software Flow Control (X-On/X-Off) Bi-directional (ENQ/Response)
Data Transmission	ASCII Format
PROCESSING	
CPU	32 Bit RISC
ROM	1M byte (4M bit x 2)
DRAM	2 MByte

All specifications subject to change without notice.

SPECIFICATION	M-8485S/M-8459S/M-8460S	M-8490S
MATRIX FONTS		
U Font	(5 dots W x 9 dots H)	
S Font	(8 dots W x 15 dots H)	
M Font	(13 dots W x 20 dots H)	
XU Font	(5 dots W x 9 dots H) Helvetica	
XS Font	(17 dots Wx 17 dots H) Univers Condensed Bold	
XM Font	(24 dots W x 24 dots H) Univers Condensed Bold	
OA Font	(15 dots W x 22 dots H) OCR-A	(22 dots W x 33 dots H) OCR A
OB Font	20 dots W x 24 dots H) OCR-B	(30 dots W x 36 dots H) OCR B
AUTO SMOOTHING FONTS		
WB	WB Font (18 dots W x 30 dots H)	
WL	WL Font (28 dot W x 52 dots H)	
XB	XB Font (48 dots W x 48 dots H) Univers Condensed Bold	
XL	XL Font (48 dot W x 48 dots H) Sans Serif	
VECTOR FONT		
	Proportional or Fixed Spacing Font Size 50 x 50 dots to 999 x 999 dots Helvetica, 10 Font Variations	
DOWNLOADABLE FONTS		
	TrueType Fonts with Optional Memory Card	
CHARACTER CONTROL		
	Expansion up to 12X in either the X or Y coordinates Character Pitch control Line Space control Journal Print facility 0°, 90°, 180° and 270° Rotation	

All specifications subject to change without notice.

SPECIFICATION	ALL
SYMBOLOLOGIES	
	Bookland (UPC/EAN Supplemental) EAN-8, EAN-13 CODABAR Code 39 Code 93 Code 128 Interleaved 2 of 5 Industrial 2 of 5 Matrix 2 of 5 MSI POSTNET UCC/EAN-128 UPC-A and UPC-E Data Matrix Maxicode PDF417
Ratios	1:2, 1:3, 2:5 User definable bar widths
Bar Height	4 to 600 dots, User programmable
Rotation	0°, 90°, 180° and 270°
OTHER FEATURES	
Sequential Numbering	Sequential numbering of both numerics and bar codes
Custom Characters	RAM storage for special characters
Graphics	Full dot addressable graphics, SATO Hex/Binary or .PCX formats
Form Overlay	Form overlay for high-speed editing of complex formats.

All specifications subject to change without notice.

SPECIFICATION	M-8485S/M-8459S/M-8490S	M-8460S
DIMENSIONS		
Wide	9.65 in. (245 mm)	
Deep	16.1 in. (408 mm)	17.9 in. 455 mm
High	11.8 in. (300 mm)	
WEIGHT	25.0 lbs (11.34 Kg)	27.5 lbs 12.5 Kg
POWER REQUIREMENTS		
Voltage	100 - 115 V (±10 %) 220V (±10 %) 50/60 Hz (±1%)	
Power Consumption	50W Idle 700W Operating	
ENVIRONMENTAL		
Operating Temperature	41° to 104°F (5° to 40°C)	
Storage Temperature	-0° to 104°F (-20° to 40°C)	
Operating Humidity	15-85 % RH, non-condensing	
Storage Humidity	Max 90% RH, non-condensing	
Electrostatic Discharge	8KV	
REGULATORY APPROVALS		
Safety	UL, CSA, CE ⁽¹⁾	
RFI/EMI	FCC Class A	

All specifications subject to change without notice.

(1) CE approval on M-8460S only

ACCESSORY	M-8485S/M-8459S/M-8490S	M-8460S
MEMORY EXPANSION	Two slots for PCMCIA Memory Cards (up to 2MB each). Can be used for Graphic File storage, print buffer expansion, format storage and downloaded TrueType fonts.	
CALENDAR	An internally mounted Date/Time clock that can be used to date/time stamp labels at the time of printing.	
FACE-OUT LABEL SENSOR	Top-mounted sensor for reflective Eye-Marks printed on the face of the label.	N/A

All specifications subject to change without notice.

SECTION 2. INSTALLATION

INTRODUCTION

This section of the manual has been written to help you install the SATO “S” print engine modules and to get started as quickly as possible.

It is recommend to read each chapter in this manual before the installation or the use of the print modules.

INSTALLATION

Careful consideration must be given when selecting the location of the printer, especially to environmental considerations. To obtain optimum results from the SATO “S” print module, always try to avoid operation locations influenced by:

- Direct or bright sunlight, as this will make the label sensor less responsive and may cause the label to be sensed incorrectly.
- Locations which have extremes of temperature, as this can create electrical problems on the circuits within the printer.
- The installed location of the printer should ideally be in areas free from dust, humidity and sudden vibrations.

CONSUMABLES

Always use SATO carbon ribbons or equivalent in the thermal transfer models. The use of incorrect materials may cause malfunctions of the printer and void the warranty.

DIMENSIONS

Note: The exact position of components may vary depending on model.

Width:	10.4 inches	265 mm
Depth:	16.06 inches	417 mm
Depth M-8460S Only:	17.8 inches	452 mm
Height:	11.8 inches	303 mm

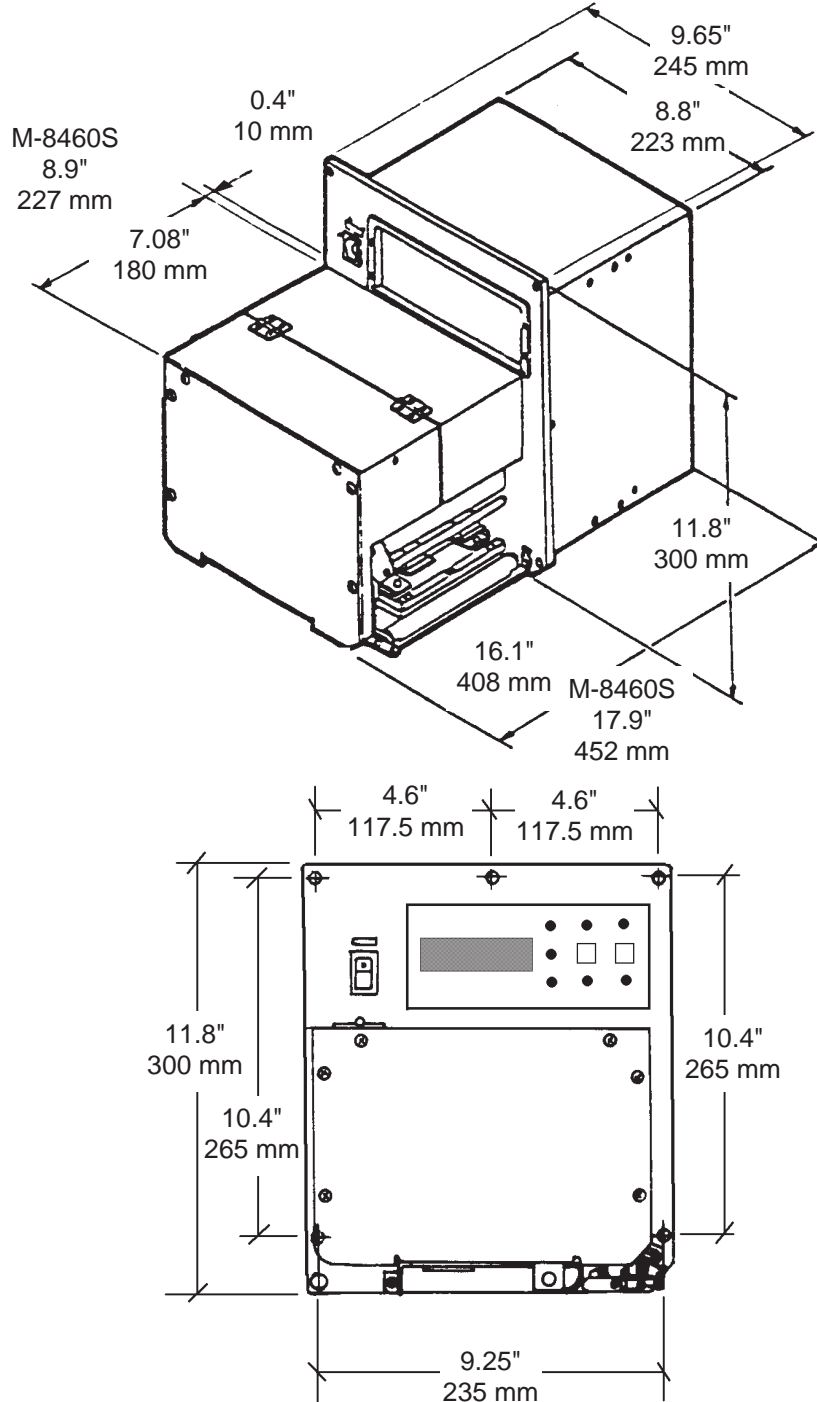

COMPONENT NAMES

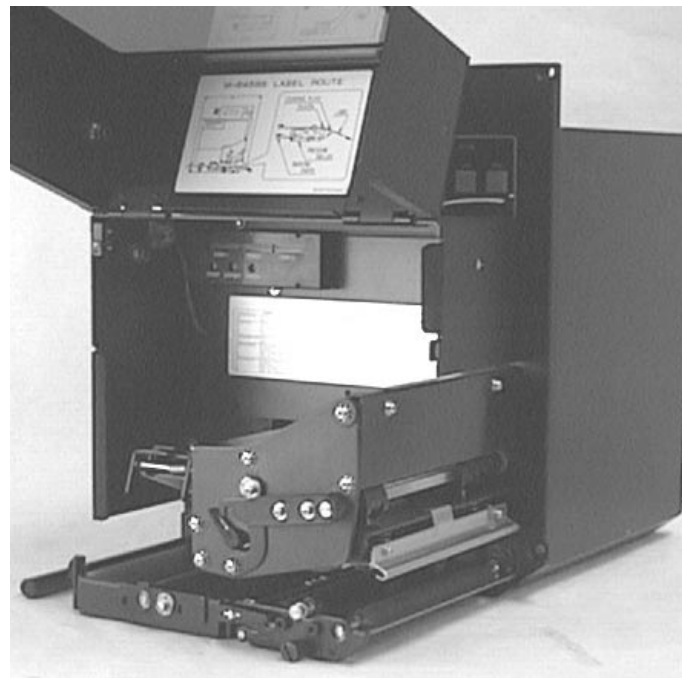
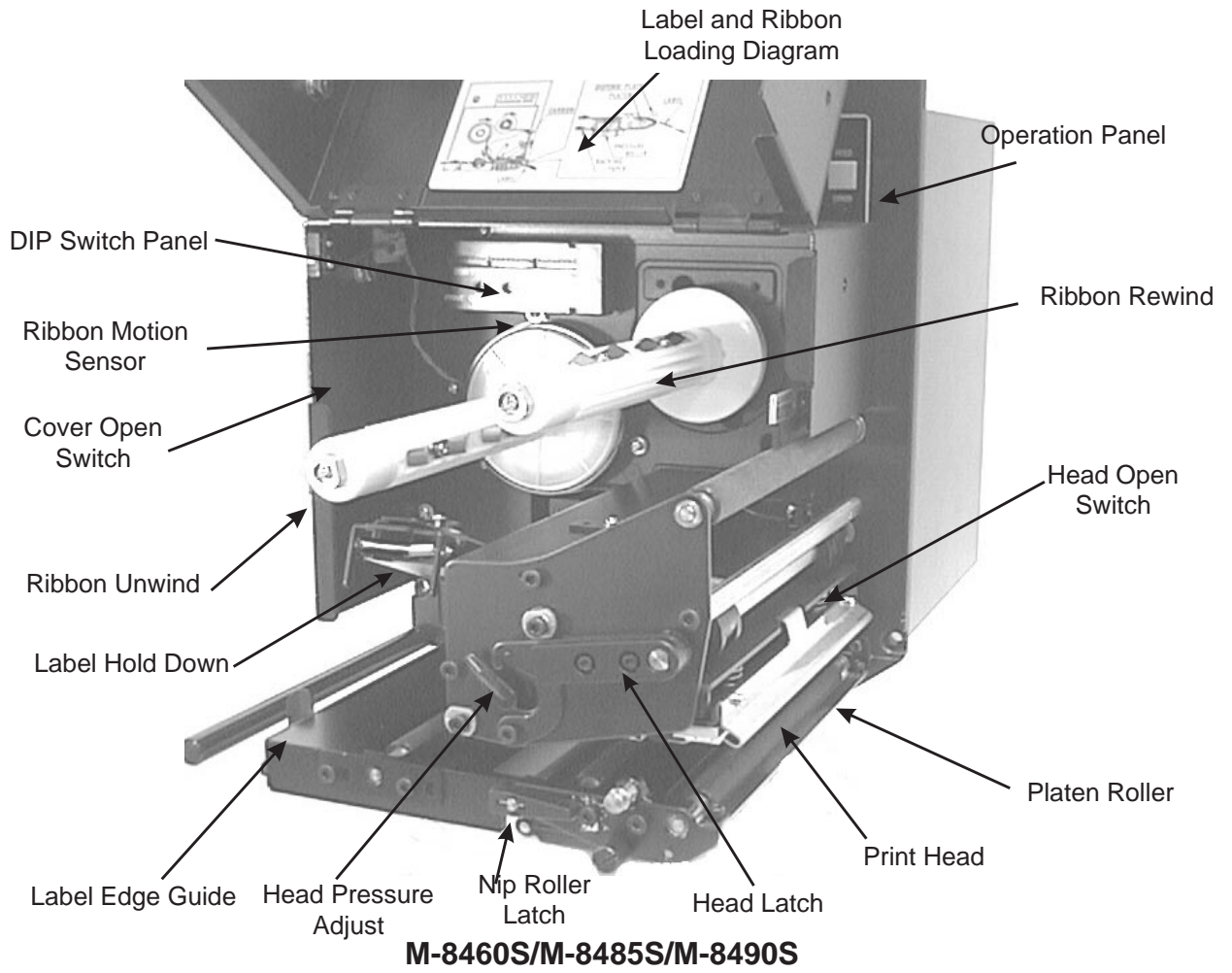

REAR PANEL



- Power On/Off Switch:** To turn power On or Off
- Operation Panel** To set up the various configurations and to display dispensing quantity and the various alarms. The details of these are described on page 3-5
- Adjustment Panel** Potentiometers (inside label compartment) to make setup adjustments. The details of these are described on page 3-19.
- AC Input Connector** To input 115V 50/60 Hz. Use the power cable provided.
- AC Fuse** To protect the machine from abnormal power input. Type 15A/250V.
- Serial I/F Connector** Connects to the RS-232C serial port of the host.
- Parallel I/F Connector** Connects to the Centronics parallel port of the host.
- EXT Connector** This is an external signal connector for interfacing with the label applicator system.
- Memory Card** Connectors for Optional PCMCIA Memory Cards.

SWITCHES AND SENSORS

- Cover Open Switch:** The print head mechanism cover is fitted with a micro switch. When the cover is opened, this switch is activated and the printer will stop printing.
- Ribbon Motion Sensor:** The sensor will react to the carbon ribbon unwind when approximately 46 feet of ribbon remain. This sensor is a motion detector that signals the printer when the ribbon supply is turning. This sensor is used for both the ribbon end and ribbon near end sensing.
- Note: The M-8459S Direct Thermal print engine does not use a Ribbon Motion Sensor.*
- Head Open Switch:** When the print head is opened, this switch is activated and the printer will stop printing.
- Label Sensor:** This sensor unit contains two sensors for both label gap and Eye-mark sensing.

MEDIA LOADING

Ribbon Loading (not applicable for the M-8459S)

1. Open the print head by rotating the Head Latch until the head releases. It is spring-loaded in the open position.
2. Place a new ribbon roll on the Ribbon Unwind Spindle and push it onto the spindle as far as it will go. Make sure the ribbon will unwind from the top of the roll. Note that all SATO ribbons are wound face-in (the ink or dull side faces toward the inside of the roll).
3. Place an empty ribbon core on the Ribbon Wind Spindle and push it onto the spindle as far as it will go.
4. Unwind the clear ribbon leader until about 12 inches of leader/ribbon are off the roll.
5. Route the ribbon as shown in the Ribbon Routing Diagram on the inside of the cover.
6. Tape the end of the ribbon leader to the empty core so that it will underneath the core and over the top (see diagram on inside of cover).
7. Manually wind approximately three turns of ribbon on the core.
8. Inspect the ribbon to make sure it is not folded over or excessively wrinkled as it passes over the print head.
9. If labels are already loaded, close and latch the print head.

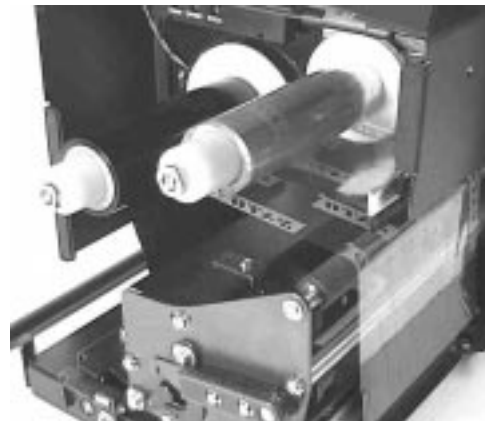
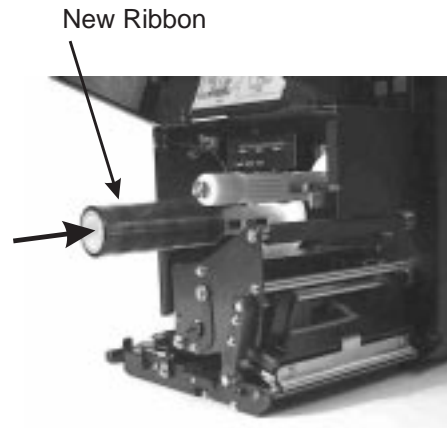

Loading the Label Stock

1. Open the print head by rotating the Head Latch until the head releases. It is spring-loaded in the open position.
2. Unlatch the Label Hold Down by lifting up on the latch. It is spring-loaded in the open position.
3. Pull the Label Edge Guide all the way out.
4. Remove approximately 18 inches of labels from the backing liner.
5. Route the label liner under the Label Hold Down and under the print head and out the front of the printer.
6. Pull the liner through the printer until the first label is positioned under the Label Hold Down.
7. Push the labels in until they contact the inside edge of the printer, then position the Label Edge Guide until it lightly contacts the outside edge of the label liner.
8. Close and latch the Label Hold Down and Print Head.
9. Release the Nip Roller Hold Down by rotating the Nip Roller Latch tab clockwise. The Nip Roller Hold Down will swing down.
10. Route the liner over the peel bar and back between the Nip Roller Hold Down and the Nip Roller.
11. Pull the liner tight. Close the Nip Roller Hold Down by pushing upward until it latches in place. Make sure the Nip Roller Latch is securely engaged.

Note: Always check that the backing paper is taut between Platen Roller and Nip Roller.

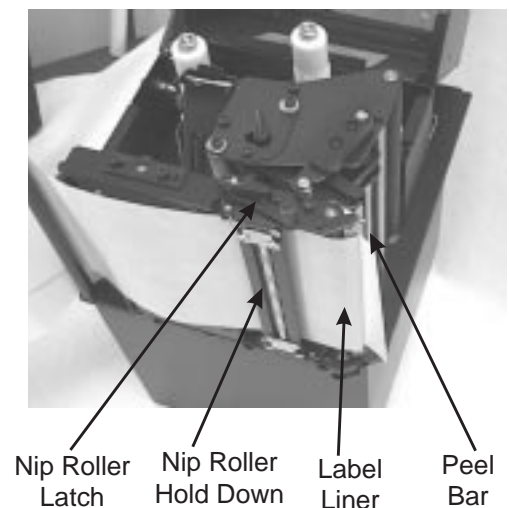
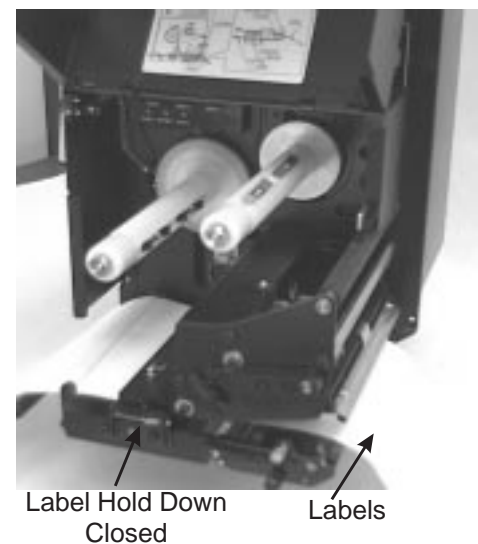
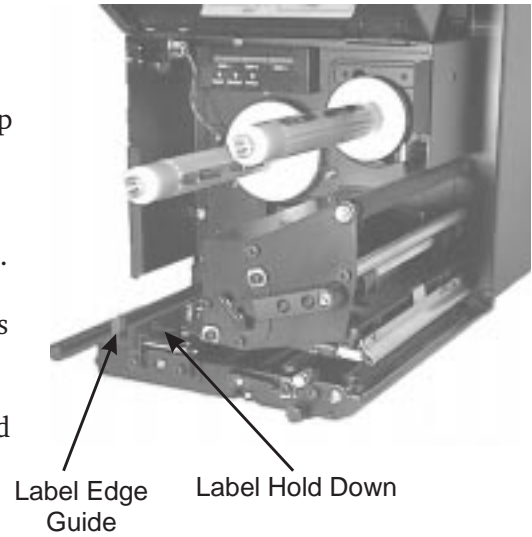

12. Power the printer on and press the Feed key. It should feed labels until the first label is peeled and ready for application.

ADJUSTING THE LABEL SENSOR

The “S” printers can position labels using either a label gap (transmissive) or an Eye-Mark (reflective) sensor. The sensor used is selected by DSW2-2 (page 3-2). The gap sensor position can be adjusted over a limited range. In addition, the signals from the sensors can be adjusted using the LCD panel (page 3-13) to compensate for different liner opacities and/or Eye-Mark reflectance values.

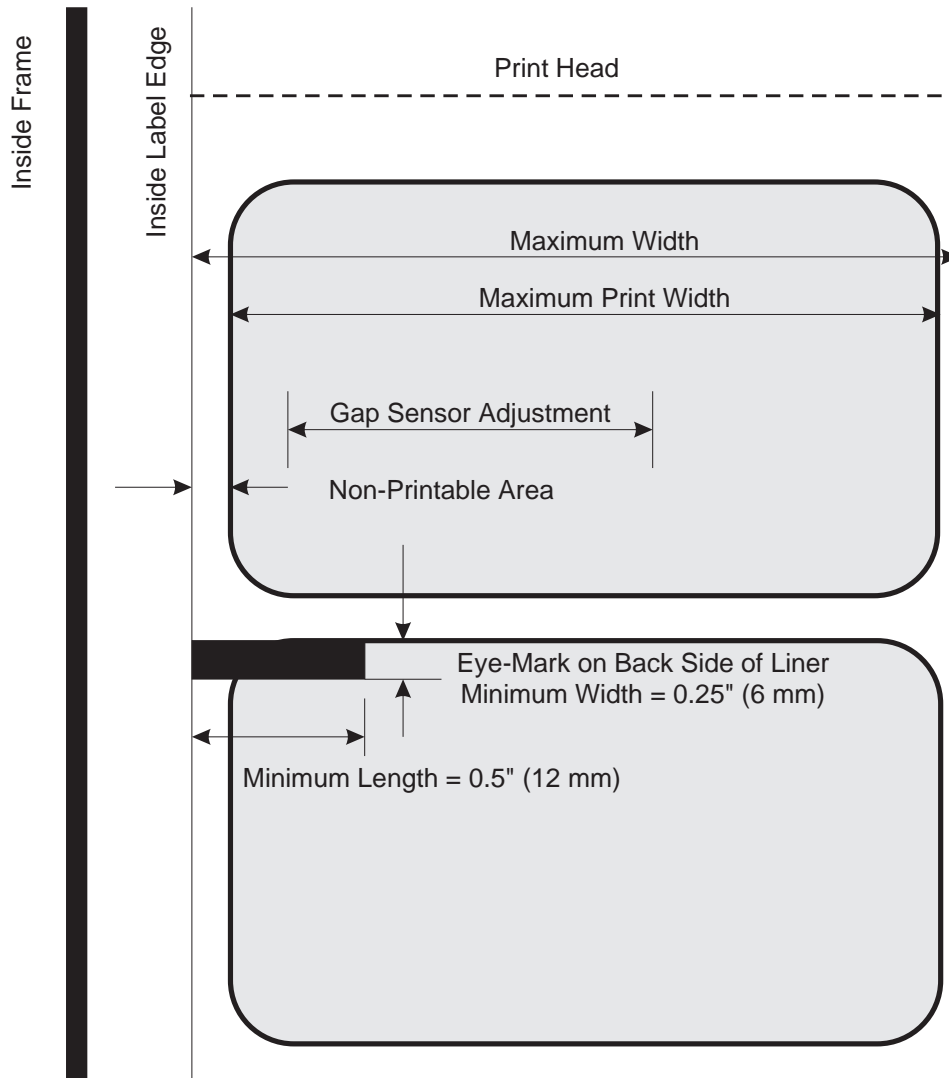

	M-8459S	M-8460S	M-8485S	M-8490S
Max Label Width (includes liner)	5.27" (134 mm)	6.5" (165 mm)	5.27" (134 mm)	5.27" (134 mm)
Max Print Width	4.4" (112 mm)	6.0" (152 mm)	5.0" (128 mm)	4.4" (112 mm)
Gap Sensor Adjustment Range	0.5" to 2.67" 14 mm to 68 mm	0.5" to 3.25" 14 mm to 82 mm	0.5" to 2.67" 14 mm to 68 mm	0.5" to 2.67" 14 mm to 68 mm
Non-Print Area	0.12" (3 mm)	0.12" or 0.25" 3 mm or 6.5 mm	0.12" (3 mm)	0.12" (3 mm)

ADJUSTING SENSOR POSITION

The label gap (transmissive) sensor can be positioned over a limited (see table on page 2-9). The movable sensor assembly is mounted on the Label Hold Down and is held in position by two screws. To adjust the position of the sensor, both screws must be loosened and the sensor moved to the desired position in the slot, and then the screws retightened. Adjustments to compensate for different liner opacity is done with the LCD panel (see page 3-13).

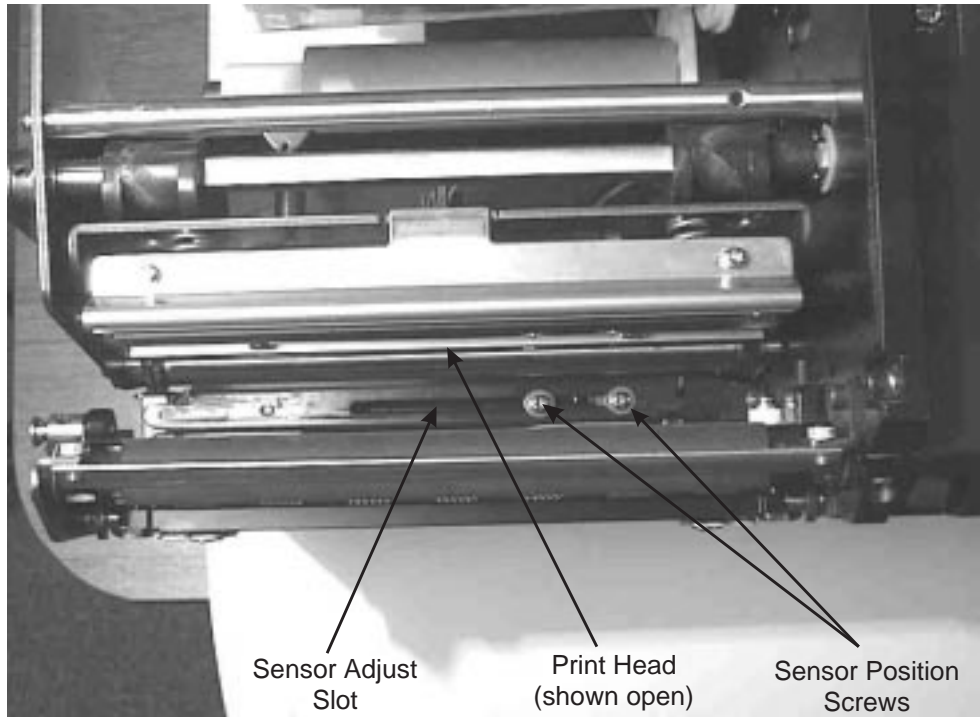

OPERATION PANEL

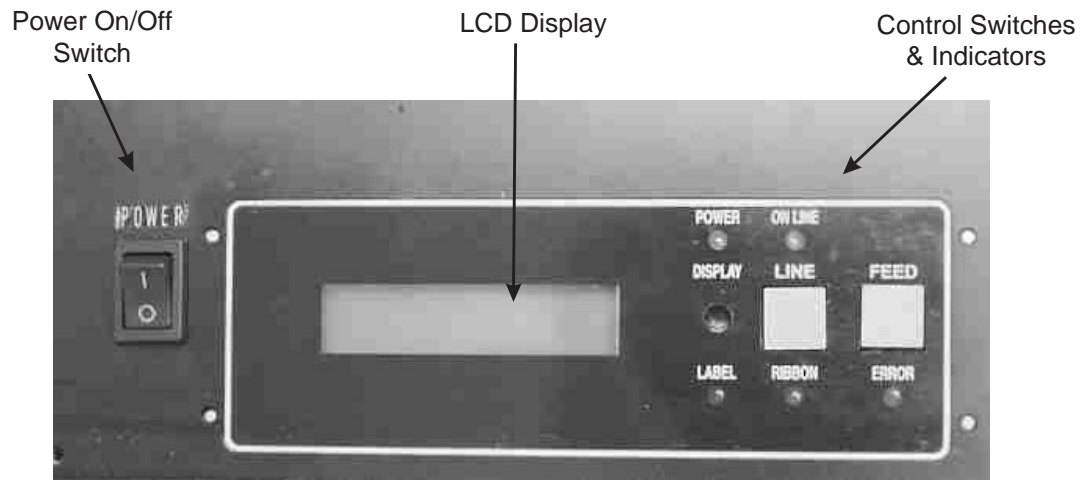

Operation Panel

LCD Display	2 Line x 16 Character display.
LABEL LED	Illuminated when label is out.
RIBBON LED	Illuminated when ribbon is out. Not used on the M-8459S
ERROR LED	Illuminated when errors have occurred.
ON-LINE LED	Illuminated when printer is On-Line.
LINE Key:	Switches the printer On-Line or Off-Line. It can also be used as a Pause function key to stop label during the printing process.
FEED Key	To feed one blank label.
DISPLAY	Potentiometer for adjusting the contrast of the LCD

DIP SWITCH PANEL

The DIP Switch panel is located inside the cover and contains three 8-position DIP switches and three adjustment potentiometers. Adjustment procedures for these are listed in Section 3: Configuration.

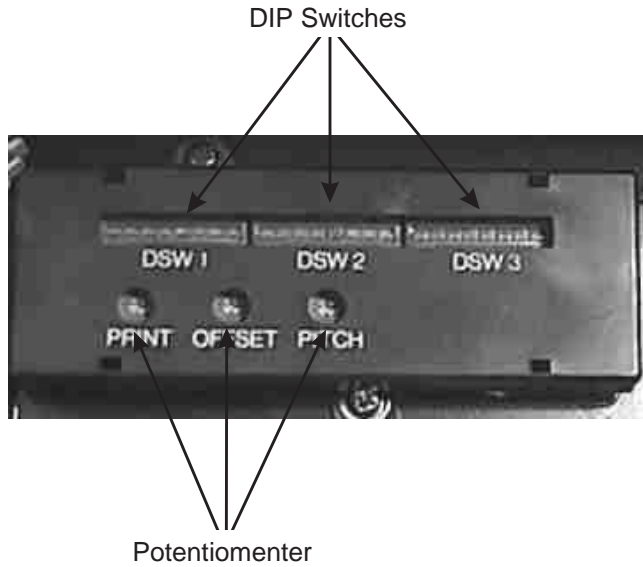

SECTION 3. CONFIGURATION

PRINTER DIP SWITCH CONFIGURATION

DIP Switch Panels

There are three DIP switches (DSW1, DSW2 and DSW3). These are located inside the cover. These switches can be used to set:

- RS232C transmit/receive parameters
- Thermal transfer or direct thermal mode
- Label sensor enable/disable
- Head check mode
- Hex dump mode
- Receive buffer size
- Operation mode

Each switch is an eight section toggle switch. The ON position is always to the top. To set the switches, first power the unit Off, then position the DIP switches. Finally, after placing the switches in the desired positions, power the printer back on. The switch settings are read by the printer electronics during the power up sequence. They will not become effective until the power is cycled.

RS232 Transmit/Receive Setting

Data Bit Selection (DSW1-1). This switch sets the printer to receive either 7 or 8 bit data bits for each byte transmitted.

DSW1-1	SETTING
Off	8 data bits
On	7 data bits

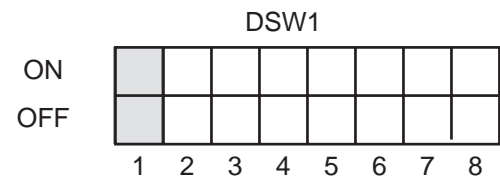

Parity Selection (DSW1-2, DSW1-3). These switches select the type of parity used for error detection.

DSW1-2	DSW1-3	SETTING
Off	Off	No Parity
Off	On	Even
On	Off	Odd
On	On	Not Used

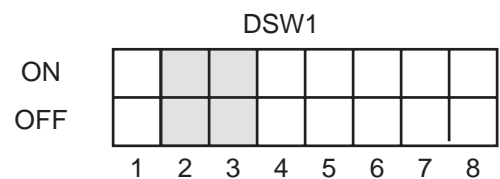

Stop Bit Selection (DSW1-4). Selects the number of stop bits to end each byte transmission.

DSW1-4	SETTING
Off	1 Stop Bit
On	2 Stop Bits

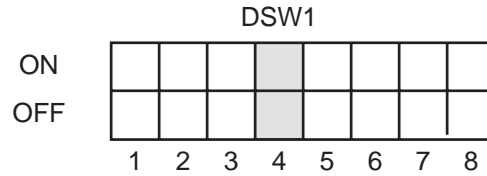

Baud Rate Selection (DSW1-5, DSW1-6). Selects the data rate (bps) for the RS232 port.

DSW1-5	DSW1-6	SETTING
Off	Off	9600
Off	On	19200
On	Off	4800
On	On	2400

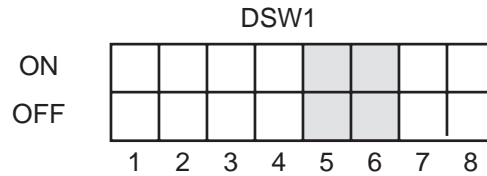

Protocol Selection (DSW1-7, DSW1-8). Selects the flow control and status reporting protocols. See Section 5: Interface Specifications for more information.

DSW1-7	DSW1-8	SETTING
Off	Off	Rdy/Bsy
Off	On	Xon/Xoff
On	Off	Bi-Com
On	On	Not Used

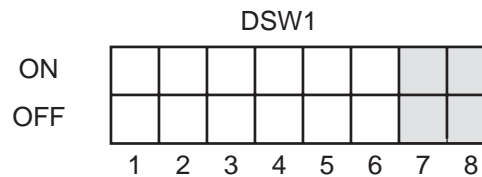

Printer Set Up

Print Mode Selection (DSW2-1). Selects between direct thermal printing on thermally sensitive paper and thermal transfer printing using a ribbon. *Note: This switch is not used on the M-8459S.*

DSW2-1	SETTING
Off	Therm Xfr
On	Direct Therm

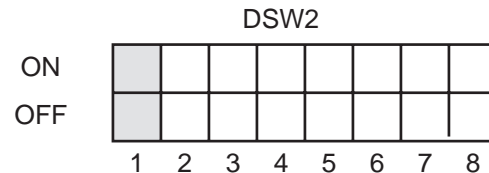

Sensor Type Selection (DSW2-2). Selects between the use of a label gap or a reflective Eye-Mark detector. See page 2-9 for the location of these sensors.

DSW2-2	SETTING
Off	Gap
On	Eye-Mark

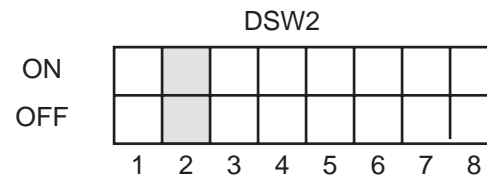

Head Check Selection (DSW2-3). When selected, the printer will check for head elements that are electrically malfunctioning.

DSW2-3	SETTING
Off	Disabled
On	Enabled

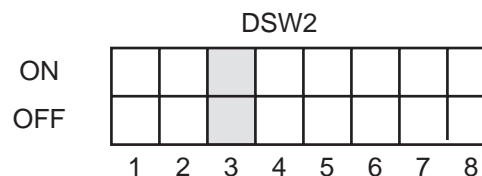

Hex Dump Selection (DSW2-4). Selects Hex Dump mode (see page 3-21).

DSW2-4	SETTING
Off	Disabled
On	Enabled

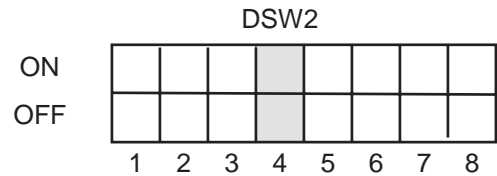

Receive Buffer Selection(DSW2-5). Selects the operating mode of the receive buffer. See Section 5: Interface Specifications for more information.

DSW2-5	SETTING
Off	Single Job
On	Multi Job

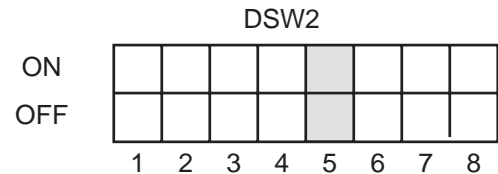

Protocol Code Selection (DSW2-7). Selects the command codes used for protocol control. Refer to page E-1 for more information.

DSW2-7	SETTING
Off	Standard
On	Non-Std

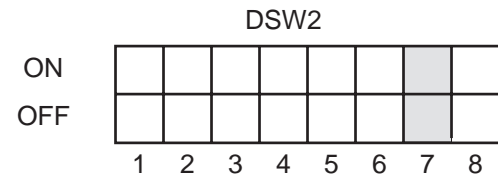

M8400S Emulation Mode (DSW2-8). For emulating special M8400S series software commands. Should be used only if problems are encountered when using existing M8400S software.

DSW2-8	SETTING
Off	Disabled
On	Enabled

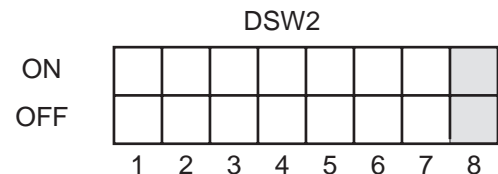

Backfeed Selection (DSW3-1). Backfeed is used to correctly position the label for application and then retract the next label to the proper print position. This operation can be performed immediately after a label is printed and used, or immediately prior to the printing of the next label.

DSW3-1	SETTING
Off	Before
On	After

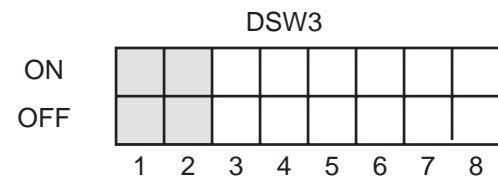

Label Sensor Selection (DSW3-3). Enables or disables the Label Sensor. If the Sensor is enabled, it will detect the edge of the label and position it automatically. If it is disabled, the positioning must be under software control using Line Feed commands.

DSW3-3	SETTING
Off	Sensor Used
On	Not Used

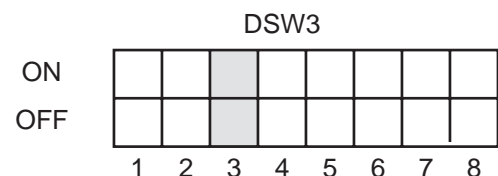

Back-Feed Selection (DSW3-4). When Back-Feed is enabled, the printer will position the last printed label for dispensing and retract it before printing the next label. The amount of backfeed offset is adjustable See page 3-19 for information on setting the amount of offset.

DSW3-4	SETTING
Off	Enabled
On	Disabled

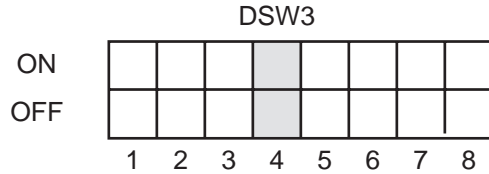

External Signal Interface. See Section 5: Interface Specifications for information on the External Signals.

EXT Print Start Signal Selection (DSW3-5). Allows an external device to initiate a label print for synchronization with the applicator. See page 6-11 for a description of the signal level and requirements.

DSW3-5	SETTING
Off	Enabled
On	Disabled

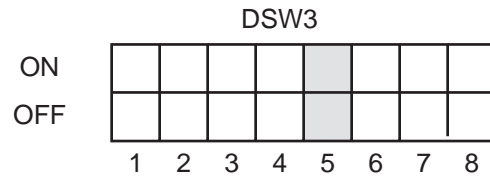

External Signal Type Selection (DSW3-6, DSW3-7). Both the polarity and signal type (level or pulse) of the external print synchronizing signal can be selected. See page 6-11 for a definition of signal types.

DSW3-6	DSW3-7	SETTING
Off	Off	Type 4
Off	On	Type 3
On	Off	Type 2
On	On	Type 1

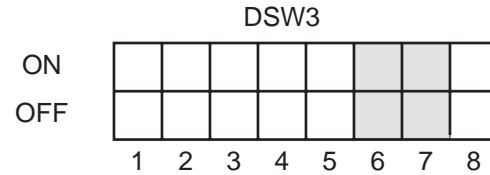

Repeat Print via External Signal (DSW3-8). Allows the applicator to reprint the current label in the print buffer. See page 6-11 for a description of the signal requirements.

DSW3-8	SETTING
Off	Disabled
On	Enabled

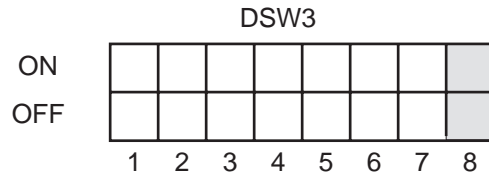

Reserved for Future Use (DSW2-6, DSW3-2)

Note: The Centronics (Parallel) communications port are always enabled regardless of the settings for the RS232 port. There are no settings for Centronics! Both the Centronics and RS232 ports are active at all times. Care should be taken to ensure that data is not transmitted to both ports simultaneously as the received message will be corrupted.

Default Settings

Switch Selections - All switches are placed in the Off position (default) for shipping. This will result in the following operating configuration:

Communications:	8 data bits, no parity, 1 Stop bit, 9600 Baud
Protocol:	Ready/Busy
Sensor:	Gap Sensor
Receive Buffer:	Single Job
Mode:	Batch/continuous
Label Sensor:	Sensor Used
Backfeed:	Disabled
External Signals:	Disabled

Software Default Settings - The printer stores the software settings upon receipt and uses them until they are again changed by receipt of a command containing a new setting. These settings are stored in non-volatile RAM and are not affected by powering the printer off. The printer may be reset to use the default software settings by depressing the **LINE** and **FEED** keys simultaneously while powering the printer on. This will result in the following default configuration:

	M-8459S	M-8460S	M-8485S	M-8490S
Print Darkness	3	2	2	2
Print Speed	4 in. per sec.	6 in. per sec.	6 in. per sec.	6 in. per sec.
Print Reference	Vertical = 0000, Horizontal = 0000			
Zero	Slash			
Auto On Line	Enabled			

Once the default operation is completed, a SATO DEFAULT COMPLETED message will be displayed on the LCD panel or a single beep will be heard if the printer does not have an LCD panel. The printer should be powered off while this message is being displayed (or after the beep is heard). This saves the default settings in the EEPROM where they will be automatically loaded the next time the printer is powered on.

*SATO DEFAULT
COMPLETED*

PRINTER ADJUSTMENTS

LCD PANEL

The LCD Panel is used in conjunction with the **LINE** and **FEED** switches by the operator to manually enter printer configuration settings. Many of the settings can also be controlled via software commands and in the case of conflict between software and control panel settings, the printer will always use the last valid setting. If you load a label job that includes software settings and then enter a new setting via the Operation Panel, the manually set values will be used by the printer. If you set the values manually and then download a job with software settings, the software settings will be used.

POWER ON

Normal/User Mode	<i>ON LINE</i>
POWER	<i>QTY:000000</i>
	Page 3-7
Print Test Labels	<i>USER TEST PRINT</i>
POWER + FEED	<i>LARGE SMALL</i>
	Page 3-16
Advanced Mode Settings and Adjustments	<i>ADVANCED MODE</i>
POWER + LINE	<i>SETUP</i>
	Page 3-10
Load SATO Default Settings	<i>SATO DEFAULT</i>
POWER + FEED + LINE	<i>COMPLETED</i>
	Page 3-5
Download User Defined Protocol Codes	<i>USER DOWNLOAD</i>
POWER + LINE + DSW2-7=ON	
	Page E-2
Reset to SATO Default Protocol Codes	<i>ALT PROTOCOL</i>
POWER + LINE + FEED + DSW2-7=ON	<i>DEFAULT COMPLETE</i>
	Page E-2
Print Hex Dump Label	Print Buffer
POWER , then DSW2-4=ON	Hex Dump Label
	Page 3-21
Print Hex Dump Label	Receive Buffer
POWER + DSW2-4=ON	Hex Dump Label
	Page 3-21

Normal Mode

When the printer is powered on, the readout should display the following message:



The LCD Panel will display the Online status on the top line of the display and the the bottom line will contain the label quantity (QTY) status. The ON LINE message will be changed to OFF LINE whenever the printer is switched offline by depressing the **LINE** key. As soon as a print job is received, the QTY message will indicate the number of labels to be printed. As soon as the label job begins to print, the display will indicate the number of labels remaining in the print job that remain to be printed.

User Mode

To enter the USER mode:

1. The printer is first taken offline by pressing the **LINE** key once. The display will change to:

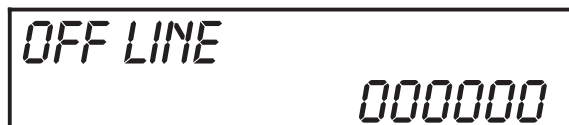

2. When the display changes to OFF LINE, press the **FEED** and **LINE** keys simultaneously for more than one second.

The printer now displays the first USER mode adjustment (Print Darkness).

Print Darkness Setting

There are three (five on the M-8459S) **Darkness** (or heat range) settings. The higher numbers represent darker settings. The current setting is indicated by an underline under one of the range settings. To change the setting:.



1. Use the **LINE** key to step the underline cursor to the desired setting.
2. Once the correct setting is underlined, press the **FEED** key to accept the setting and advance to the next adjustment.

Note: This setting can be overridden by software (see Print Darkness page 5-52).

After setting the heat range with this command, finer adjustments can be made using the PRINT potentiometer adjustment on the Adjustment panel. See *Section 4: CLEANING AND MAINTENANCE*, for additional information on how to make this adjustment for optimum print quality.

Print Speed Adjustment

There are three SPEED settings on the M-8490S/M-8460S and four on the M-8485S/M-8459S. The setting is listed on the bottom line of the display. The current setting is indicated by an underline under one of the speed settings. To change the setting:



	M-8459S	M-8485S	M-8460S/M-8490S
Print Speed Setting	2 = 2 ips 3 = 3ips 4 = 4 ips 5 = 5 ips	4 = 4 ips 6 = 6 ips 8 = 8 ips 10 = 10 ips	4 = 4 ips 6 = 6 ips 8 = 8 ips

1. Use the **LINE** key to step the underline cursor to the desired speed setting.
2. Once the correct setting is underlined, press the **FEED** key to accept the setting and advance to the next adjustment.

Note: This setting can be overridden by software (see Print Speed, page 5-58).

See Section 4: *CLEANING AND MAINTENANCE*, for additional information on how to make this adjustment for optimum print quality.

Pitch Offset and Direction

The label Pitch is the distance from the leading edge (the edge that comes out of the printer first) of a label and the leading edge of the next label. The leading edge position of the label can be adjusted relative to the print head +/- 49 mm in increments of 1 mm using the following procedure. Once the position is set, it can be adjusted +/- 3.75mm using the PITCH potentiometer on the Adjustment panel (see page 3-19).



1. The underline cursor will be positioned underneath the Pitch Direction setting. Pressing the **LINE** key will step the setting to the positive (+)/ negative (-) selection. A positive selection moves the leading edge of the label forward (away from the print mechanism) while a negative selection moves the leading edge of the label back into the mechanism.
2. Once the correct setting is selected, pressing the **FEED** key will accept the setting and advance to the Pitch Offset adjustment.
3. Use the **LINE** key to step the first digit of the counter to the desired position. The display will increment one step for each time the **LINE** key is pressed. The reading will advance to a setting of 4 after which it will automatically wrap and

start at 4 again. The Pitch Direction set in the previous step will be displayed in front of the Offset setting.

- Once the setting is correct, pressing the **FEED** key will accept the setting and advance to the next Offset digit. Again use the **LINE** key to step to the desired setting (0 thru 9). Once the setting is correct, pressing the **FEED** key will accept the setting and advance to the Cancel Print Job display.
- You may wish to check your settings by printing a test label after you have completed the adjustments to ensure that they are correct. See page 3-16 for instructions on how to print a test label.

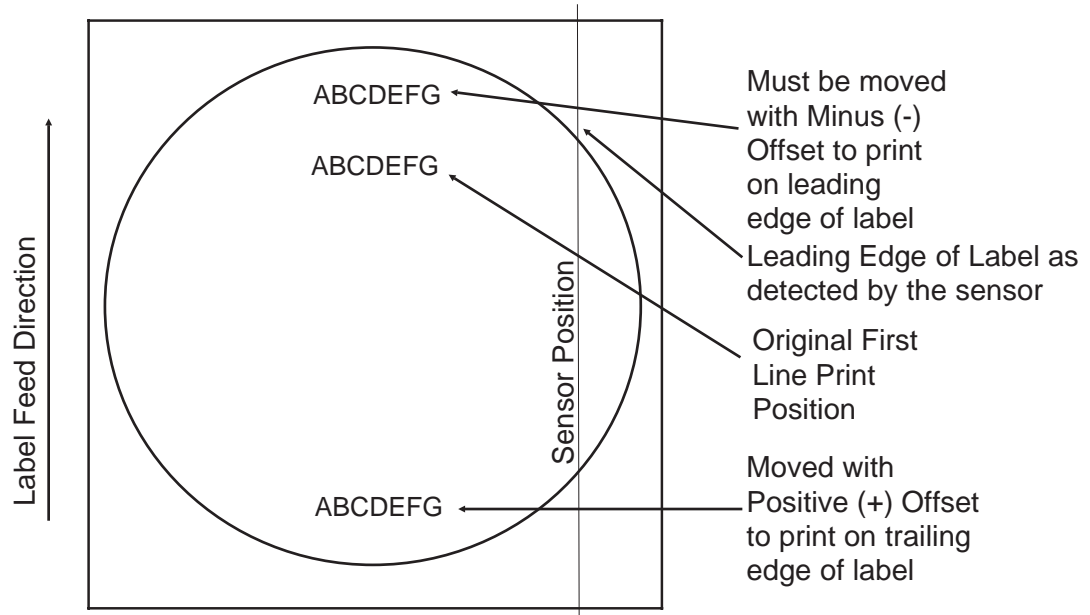

Cancel Print Job

If the printer has a print job(s) loaded in memory, selecting YES will cause the job(s) to be cleared. The default selection is NO. Make sure that you want to cancel the print job before selecting YES as the job cannot be recovered and will have to be retransmitted to the printer.



- Use the **LINE** key to step the underline cursor to either the YES or NO selection.
- Once the correct setting is underlined, pressing the **FEED** key will accept the setting and terminate the User Mode of operation and return you to the Normal Mode OFF LINE display.

If you wish to change any of the settings, you must enter the User Mode again by simultaneously pressing **FEED** and **LINE** keys for more than one second.

Advanced Mode Setup

An Advanced Setup Mode is provided to make adjustments that require only occasional adjustments. Since they affect the basic operation of the printer, the procedure for entering this mode is designed to prevent someone from accidentally changing the settings.

To enter the Advanced Mode, the printer is powered on while pressing the **LINE** key. The printer will beep one time and display Advanced Mode on the LCD panel. *Note: Pressing the LINE key at this time will take you to the Advanced Mode Counters display(see page 3-16).*

Pressing the **FEED** key will advance the display to the first setting selection.

Zero Slash Setting

This setting determines if a zero is printed with a slash or without a slash. This setting can also be controlled via software commands. When YES is selected, the U, S, M, WB, WL, XU, XS, XM, XB, XL and vector fonts will have a slash through the center of the zero character.

1. Use the **LINE** key to step the underline cursor to either the YES or NO selection.
2. Once the correct setting is underlined, pressing the **FEED** key will accept the setting and advance the display to the Auto Online display.



Auto Online Setting

This setting determines the mode in which the printer powers up. If the YES selection is made, the printer powers up in the ON LINE mode and is ready to print. If NO is selected, the printer powers up in the OFF LINE mode and must be manually placed in the ON LINE mode by pressing the **LINE** key before it is ready to print.

1. Use the **LINE** key to step the underline to either the YES or NO selection.
2. Once the correct setting is underlined, pressing the **FEED** key will accept the setting and advance the display to the Vertical Offset display.



Vertical Offset Setting

Vertical Offset is the distance down from the leading edge (the edge of the label that comes out of the printer first) to the first vertical print position. It is always a positive setting since making it negative would move it up and off the printable label. This setting changes the base reference point for all subsequent label jobs. Its effect is identical to the <ESC>A3 Base Reference point command (see page 5-19). Since the printer moves the label in discrete steps equal to the size of the print dot, the units of measure for Vertical Offset distance is dots. The maximum values that can be set for the different model printers are:



Vertical Offset	M-8459S	M-8460S	M-8485S	M-8490S
Normal Length	0 to 1424	0 to 1424	0 to 1424	0 to 2136
Expanded Length	0 to 2848	0 to 2848	0 to 2848	0 to 4272

Note: This setting can be overridden by the Base Reference Point Command, page 5-19).

1. The underline cursor will be positioned under the first digit of the Vertical Offset setting. Use the **LINE** key to step setting to the desired value. The display will increment one step for each time the **LINE** key is pressed.
2. Once the setting is correct for that digit, pressing the **FEED** key will accept the setting and advance to the next digit. The correct value for the second digit is set by pressing the **LINE** key. Once it is set to the correct value, pressing the **FEED** key will accept the setting and advance the cursor to the next digit. This process is repeated until all digits are correctly set. When the last digit is correctly set, pressing the **FEED** key will advance the display to the next selection.

Horizontal Offset and Direction

Horizontal Offset is distance that the label image is shifted either to the right or left on the label. The image is shifted to the left (when facing the printer) for a positive setting and it is shifted to the right for a negative setting. This setting changes the base reference point for all subsequent label jobs. Its effect is identical to the <ESC>A3 Base Reference point command (see page 5-19), Since the printer can only print in discrete steps equal to the size of the print dot, the units of measure for the Horizontal Offset distance is dots.

Note: This setting can be overridden by the Base Reference Point Command, page 5-19).



1. The underline cursor will be positioned under the Horizontal Direction setting. Use the **LINE** key to step the direction setting to the positive (+) or negative (-) value. A positive selection increases moves the horizontal reference point for the label to the right edge of the label, towards the outside, while a negative selection moves the horizontal reference point for the label to the left, towards the inside of the printer.
2. Once the correct direction setting is underlined, pressing the **FEED** key will accept the setting and advance to the first digit of the Horizontal Offset adjustment.
3. Use the **LINE** key to step the setting to the desired value. The display will increment one step for each time the **LINE** key is pressed. Pressing the **FEED** key will accept the setting and advance the underline cursor to the next digit. Use the **LINE** key to step it to the desired value and press the **FEED** key to accept the setting and advance to the next digit.

	M-8459S	M-8460S	M-8485S	M-8490S
Horizontal Offset	+/- 896	+/- 1216	+/-1024	+/- 1344

Note: The printer will not wrap images that extend beyond the print area. Any part of the image that extends beyond the print area will be truncated.

4. Once the last digit has been correctly set, pressing the **FEED** key will accept the setting and advance to the Sensor Threshold display.

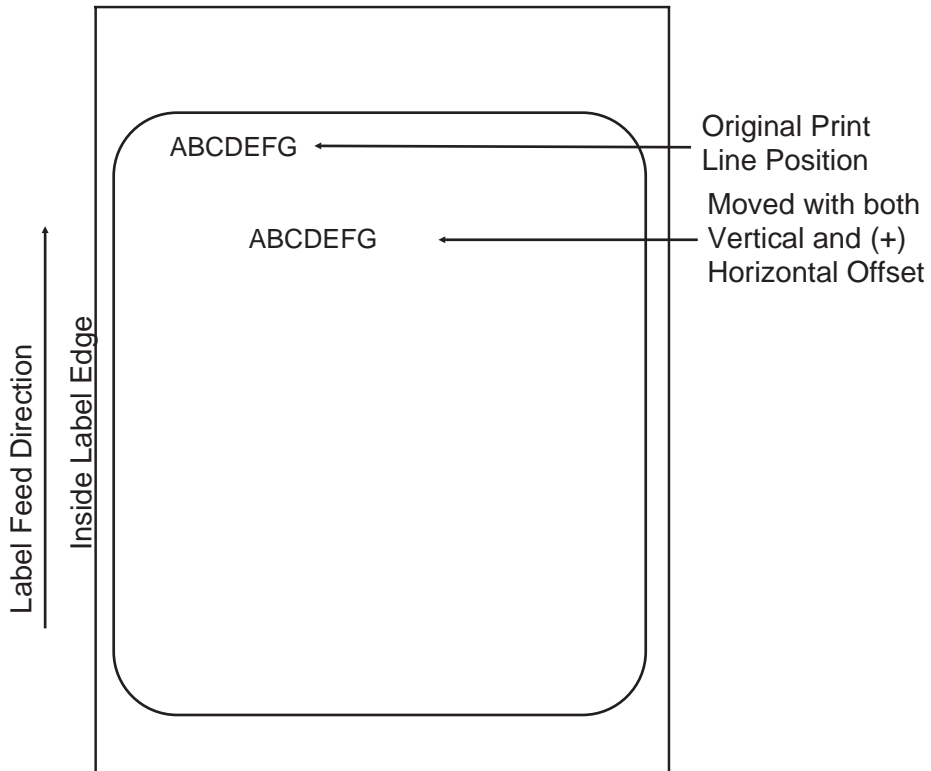

Sensor Threshold Level

The printer determines the location of the leading edge of the label by measuring the difference between light levels when it sees either a label edge or a black EYE mark. This adjustment allows you to manually set the threshold voltage level, between the maximum and minimum light levels. DIP switch DSW2-2 selects the sensor type. If **DSW2-2** is in the **OFF** position, the setting will be for a **See-Thru (or Gap) sensor** and the LCD will display **GAP** on the top line along with the current setting. If **DSW2-2** is in the **ON** position, the LCD will display **EYE** on the top line with its current setting. If the value entered for the bottom line setting is 0.0V, then the printer will automatically calculate the setting when the first label is fed after the printer is powered on or the head is closed. There are some instances where the automatically calculated value must be adjusted to ensure reliable label feeding, such as when the backing opacity or the reflectance of the EYE mark varies significantly within a roll of labels or between label rolls. In these instances the value should be set using the following procedures.



GAP - When setting the gap threshold, the voltage shown on the top line of the display must be measured with nothing but the backing in the sensor and then again with a label still attached to the backing. The formula to be used for setting the threshold is:

$$(\text{High Voltage Level} + \text{Low Voltage Level}) \times 0.5 = \text{Start Value}$$

1. Insert a label still attached to the backing into the sensor (see page 4-4 for location of the sensors) and close the Label Hold-Down. Record the voltage shown on the top line of the LCD panel. This line should have the message **GAP** on the top line (DIP switch DSW2-2 = OFF). Make sure the label is all the way under the sensor.
2. Strip the label from the backing and insert the backing strip under the sensor and close the Label Lid. Record the voltage shown on the top line of the LCD panel. The voltage ranges measured should be within the following ranges:

Backing with Label	Label Backing Only
2.0V to 3.5V	Less than 1.0V

If the measured values are outside this range, you may have trouble in finding a value that will work properly under all conditions. If this is the case, a higher quality label may be needed to get adequate performance.

3. Calculate the starting point voltage using the formula.
4. Use the **LINE** key to step the counter to the desired setting. The display will increment one step for each time the **LINE** key is pressed. If the **LINE** key is held pressed for more than two seconds, it will automatically go into the fast scroll mode. The reading will advance to a setting of 4.9 (the maximum voltage) after which it will automatically wrap and start at 0.0 again. If a value of 0.0 is set, the

printer will automatically set the level half way between the two measured voltages each time the printer is powered on with labels loaded.

5. Once the setting is correct, pressing the **FEED** key will accept the setting and advance to the Calendar Set display.
6. Repeat this procedure using values slightly higher or lower until the optimum performance is obtained. If you cannot find a setting between the high and low readings that gives adequate performance, please refer to the “S” Printer Service Manual.

EYE - When setting the eye threshold, the voltage must be measured with nothing but the label under the sensor and then again with the printed eye mark under the sensor. The formula for this is:

$$(\text{High Voltage Level} + \text{Low Voltage Level}) \times 0.5 = \text{Start Value}$$

1. Insert a label into the sensor (see *Section 3: Cleaning and Maintenance* for location of the sensors) and close the Label Hold-Down. Make sure the printed eye mark is *not* under the sensor. Record the voltage shown on the top line of the LCD panel. This line should have the message EYE on the top line (DIP switch DSW2-2 = ON).
2. Now pull the label forward until the eye mark is positioned under the sensor (the voltage reading should be at its highest point). Record the voltage shown on the top line of the LCD panel. The voltage ranges measured should be within the following ranges:

Label Only	Eye Mark
Less than 1.0V	2.5V to 3.5V

If the measured values are outside this range, you may have trouble in finding a value that will work properly under all conditions. If this is the case, a higher quality label may be needed to get adequate performance.

3. Calculate the starting point voltage using the formula.
4. Use the **LINE** key to step the counter to the desired setting. The display will increment one step for each time the **LINE** key is pressed. If the **LINE** key is held pressed for more than two seconds, it will automatically go into the fast scroll mode. The reading will advance to a setting of 4.9 (the maximum voltage) after which it will automatically wrap and start at 0.0 again. If a value of 0.0 is set, the printer will automatically set the level each time the printer is powered on with labels loaded or the head is closed.
5. Once the setting is correct, pressing the **FEED** key will accept the setting and advance to the Calendar Set display.
6. Repeat this procedure using values slightly higher or lower until the value that gives adequate performance is found. If adequate performance cannot be obtained, please refer to the “S” Printer Service Manual.

Calendar Set

If the Calendar Option is installed in the printer, the date and time can be set manually using the LCD Display or via the <ESC>WT Calendar Set command (see page 5-78). The last setting, set either manually via software command, received by the printer will be the value used. The format of the display is YY/MM/DD hh:mm (Year/Month/Day/hours:minutes). The date format is fixed and cannot be changed.



CALENDAR ENABLED
NO YES

1. To enable the Calendar feature (if installed), press the **LINE** key until the underline cursor is beneath the Y(es). If the Calendar feature is to be disabled, press the Line key until the cursor is under the N(o). When the desired setting is selected, press the **FEED** key to stop the display to the Calendar Set display.



CALENDAR
01/01/01 01:01

1. Year - The first display shown will have the two digit year selection underlined. You can scroll through the dates by pressing the LINE key. The year number will increase by one each time the **LINE** key is pressed until it reaches its maximum legal value (i.e., 99 for the year digits) at which point it will wrap around to the 00 setting.
2. Month - After you have set the correct year, pressing the **FEED** key will advance the underline cursor to the two digit Month position. You can scroll through the numbers corresponding to the month by pressing the **LINE** key. The month number will increase by one each time the **LINE** key is pressed until it reaches a value of 12 at which point it will wrap around to the 01 setting.
3. Day - After you have set the correct month, pressing the **FEED** key will advance the underline cursor to the two digit Day position. You can scroll through the numbers corresponding to the month date by pressing the **LINE** key. The date number will increase by one each time the **LINE** key is pressed until it reaches a value of 31 at which point it will wrap around to the 01 setting.
4. Hour - After you have set the correct day, pressing the **FEED** key will advance the underline cursor to the two digit Hour position. You can scroll through the numbers corresponding to the hour (using a 24 hour clock) by pressing the **LINE** key. The hour number will increase by one each time the **LINE** key is pressed until it reaches a value of 24 at which point it will wrap around to the 01 setting.
5. Minute- After you have set the correct hour, pressing the **FEED** key will advance the underline cursor to the two digit Minute position. You can scroll through the numbers corresponding to the hour by pressing the **LINE** key. The minute number will increase by one each time the line key is pressed until it reaches a value of 60 at which point it will wrap around to the 01 setting.
6. After you have set the minute, pressing the **FEED** key will accept the setting and advance to the Ignore CR/LF display.

Ignore CR/LF

Under certain circumstances, it is desirable to filter out all CR/LF combinations from the data stream. Selecting YES for this setting will strip all CR/LF commands from the data stream, including graphics and 2D bar codes.



IGNORE CR/LF
 YES NO

1. Step the underline cursor to the desired setting with the LINE key
2. Once the desired setting is selected, pressing the FEED key will accept the setting and advance to the next display.

Exit Mode

This allows you to exit the Advanced Mode or to recycle through the selections again.



EXIT MODE
 NO YES

1. Use the **LINE** key to step the underline cursor to either the YES or NO selection. The default position is NO.
2. Once the correct setting is underlined, pressing the **FEED** key will advance the display to the OFF LINE mode if YES was underlined or back to the Advanced Setup Mode display if NO was selected.

Advanced Mode Counters

An Advanced Counter Mode is provided for reading and clearing the internal counters. They allow the user to keep track of the number of centimeters of label material that has passed through the printer, how many labels have been dispensed or how many labels have been cut.

To enter the Advanced Mode, the printer is powered on while pressing the **LINE** key. The printer will beep one time and display Advanced Mode on the LCD panel.



ADVANCED MODE
 SETUP

Pressing the **LINE** key will advance the display to the Advanced Counter Mode display.



ADVANCED MODE
 COUNTERS

Pressing the **FEED** key will advance the display to the counter selections.



COUNTERS
HD DSP CUT LIFE

The counters are identified in the display as:

HD:	Head Counter (should be reset when print head is replaced)
DSP:	Dispense Counter (not used on "S" printers)
CUT:	Cutter Counter (not used on "S" printers)
LIFE:	Life Counter (cannot be reset)

1. Use the **LINE** key to step the underline cursor to the desired counter, the Head (HD) counter, Dispenser (DSP) counter, the CUT (Cutter) counter or the LIFE counter. The default position is the Head Counter. Use the **LINE** key to advance the underline cursor to the desired selection.
2. Once the correct setting is underlined, pressing the **FEED** key will display the current value (in kilometers) stored in the counter.



HEAD COUNTER 0.0

3. Pressing the **FEED** key again will advance the counter to the Clear mode. All counters with the exception of the LIFE counter may be cleared.



HEAD CTR CLR
YES NO

4. Use the **LINE** key to select the desired setting. If you only wanted to read the counter value, select NO. If you want to read the counter and reset it to 0.0, place the underline cursor under the YES. Once the desired setting is selected, pressing the **FEED** key will advance the display to the Exit Advanced Mode display. (See page 3-16).

User Test Print

This option allows you to print a test label. It is recommended that you print a test label after you have changed any of the settings in the Advanced Mode. The test label allows you to verify that you indeed did make the desired changes. To enter the User Test Print Mode, power the printer on while pressing the **FEED** key. The printer will beep. Release the **FEED** key and the printer will display the following message on the LCD panel:

1. Use the **LINE** key to step the underline cursor to either the LARGE or SMALL selection. If LARGE is underlined, a label will be printed for a maximum width label. The default position is LARGE.

If LARGE was selected, a label containing a head check pattern and the current printer setting information will be printed.



- Once the desired label size setting is underlined, pressing the **FEED** key will cause a label to be printed if LARGE was underlined. If SMALL was underlined, the display will advance to the Print Size display.

Print Size

If SMALL was selected, the Print Size message will be displayed. You must enter the width of the label. The minimum and maximum label width that can be selected is:

Label Width	M-8459S	M-8460S	M-8485S	M-8490S
Minimum	4 cm 1.6 in.			
Maximum	11 cm 4.3 in.	15 cm 5.9 in.	12 cm 4.7 in.	11 cm 4.3 in.

Pressing the **LINE** key will increment the setting by 1 cm for each time the key is pressed. Once the maximum size is reached, the display will wrap around and start incrementing at 04 cm again. Once the correct label width is selected, pressing the **FEED** key will initiate the print. The SMALL label only contains a head check pattern.



If you wish to pause the printer after it starts to print a test label, press the **LINE** key to place it Off-Line. Pressing the **LINE** key again will place the printer back On Line and the test label will resume printing. If you wish to stop the test label print, pause the printer and then turn power off without placing it On Line.

POTENTIOMETER ADJUSTMENTS

PITCH

After the pitch has been set with the LCD Control Panel, it is sometimes desirable to make minor adjustments. This can be done using the **PITCH** potentiometer on the front panel. This potentiometer is set at the factory so that it has a range of +/- 3.75 mm. The midpoint setting should have no effect on the pitch. Turning the potentiometer all the way clockwise should move the print position 3.75 mm up towards the top edge of the label. Turning it all the way counterclockwise should move the print position down 3.75 mm.

1. While depressing the **LINE** key on the front panel, power the printer on.
2. When you hear one beep from the printer, release the **LINE** key and the printer will begin printing Test Labels continuously.
3. Select the a Large or Small label width using the LCD display label and the **LINE** key. If Small is selected, you must also set the appropriate width. See page 2-39, Print Size.
4. Adjust the **PITCH** potentiometer on the front panel until the first print position is at the desired location on the label. If the potentiometer does not have enough range, then you will have to change the pitch setting using the front panel display.
5. Press the **FEED** key to stop the printer.

Adjusting the **PITCH** potentiometer will affect the stop position of the label.

BACKFEED OFFSET

When a label is printed it must be correctly positioned for dispensing and application. The Backfeed adjustment is used to position the label so that it is fully dispensed and ready for application. It may then be necessary to reposition the next label before printing. The Backfeed (repositioning of the label) operation is enabled if DSW3-4 is in the Off position. If Backfeed is enabled, placing DSW3-1 is in the Off position will cause the backfeed operation to be performed immediately before each label is printed. If DSW3-1 is in the On position, the backfeed operation is performed as soon as the dispensed label has been printed and taken from the printer.

The amount of backfeed is controlled by the **OFFSET** potentiometer on the DIP Switch Panel inside the cover. When turned all the way counterclockwise, the amount of backfeed is +3.75 mm, and -3.75 mm when turned all the way clockwise.

1. Turn the printer on.
2. Press the **LINE** key to place the printer in the Off Line status.
3. Press the **FEED** key to feed out a blank label.

4. Adjust the position using the **OFFSET** potentiometer on the front control panel and feed another label by depressing the **FEED** key. Repeat this procedure until the label is fully released from the liner.

DISPLAY

This potentiometer is used to adjust the contrast of the LCD display for optimum viewing under various lighting conditions.

PRINT

The PRINT potentiometer is used to adjust the amount of heat (i.e., power) applied to the head for printing. It provides a continuous range of adjustment. Maximum print darkness is obtained by turning the potentiometer all the way clockwise and a maximum counterclockwise setting will give the lightest print.

NOTE: The PRINT potentiometer adjustment will affect the darkness in all of the command code speed and darkness ranges (see pages 5-52 and 5-58).

HEX DUMP DIAGNOSTIC LABELS

In addition to the User Test Print Labels (see page 3-16), the printer contents of the receive and print buffers can be examined using the Hex Dump Test Labels.

Print Buffer Hex Dump

The contents of the Print Buffer can be examined using the **Hex Dump** mode. The label numbers each line of data received in the left-hand column, the data in hexadecimal format in the center columns followed by the same data in ASCII format in the right-hand column.

1. Turn the printer on.
2. Send and print label.
3. Place the printer in the Off Line mode by pressing the **LINE** key. The **LINE** LED should go out.
4. Place **DSW2-4** in the On position.
5. Press the **LINE** key to place the printer back On Line.
6. Press the **FEED** key.
7. A label should be printed containing the contents of the print buffer in Hexadecimal format.
8. Return **DSW2-4** to the off position.
9. Turn the printer off and then back on to place it back in the normal print mode.

Receive Buffer Hex Dump

The data that is being received by the printer (before it is placed in the Print Buffer) can be examined by using the **Hex Dump** Mode. The label numbers each line of data received in the left-hand column, the data in hexadecimal format in the center columns followed by the same data in ASCII format in the right-hand column.

1. Turn the printer off.
2. Place **DSW2-4** in the on position.
3. Turn the printer on.
4. Transmit the data to the printer.
5. The data received is printed out on a label in hexadecimal format.
6. Return **DSW2-4** to the off position.
7. Turn the printer off and then back on to place it back in the normal print mode.

```
00000000 1B411B483031301B 56303130301B4C30 E A H010 V0100 L0  
00000010 3230331B57423153 41544F20414D4552 203 WB1SATO AMER  
00000020 4943411B48303130 1B563235301B5742 ICA H010 V250 WB  
00000030 314D2D3834303052 560D0A1B48303130 1M-8400RV L H010  
00000040 1B563430301B4C30 3230331B57423122 V400 L0203 WB1  
00000050 4845582044554D50 2220434F4D4D414E HEX DUMP COMMAN  
00000060 441B51311B5A D Q1 Z
```

Print Buffer Hex Label

```
00000000 1B411B483031301B 56303130301B4C30 E A H010 V0100 L0  
00000010 3230331B57423153 41544F20414D4552 203 WB1SATO AMER  
00000020 4943411B48303130 1B563235301B5742 ICA H010 V250 WB  
00000030 314D2D3834303052 560D0A1B48303130 1M-8400RV L H010  
00000040 1B563430301B4C30 3230331B57423122 V400 L0203 WB1  
00000050 4845582044554D50 2220434F4D4D414E HEX DUMP COMMAN  
00000060 441B51311B5A D Q1 Z
```

Receive Buffer Hex Label

SECTION 4. CLEANING AND MAINTENANCE

INTRODUCTION

The following information is presented in this section:

- Adjusting the Print Quality
- Cleaning the Print Head, Platen and Rollers
- Replacing the Print Head
- Replacing the Fuse

ADJUSTING THE PRINT QUALITY

One of the nice features of the SATO “S” printers are their high print quality. They are equipped with two different methods of adjusting the quality of the print: print darkness and speed. When adjusting for optimum print quality, a bar code verifier system should be used. The human eye is a poor judge of the relative widths of the bars in a symbol, a characteristic that is extremely important for good bar code quality.

Print (Darkness)

This adjustment allows the user to control (within a specified range) the amount of power that is used to activate the individual print head heat elements. It is important to find a proper print darkness level based on your particular label and ribbon combination. The printed images should not be too light nor should the ink from the ribbon “bleed.” The edges of each image should be crisp and well defined.

The Print Darkness can be set using the front panel LCD panel (see page 3-7) or by downloading the setting using the Print Darkeness software command (see page 5-52). Once the range has been selected, the **PRINT** Potentiometer on the front panel can be used to make finer adjustments.



PRINT Potentiometer

The primary adjustment for Print Darkness is the **PRINT** potentiometer on the operator panel. It provides a continuous range of adjustment, allowing you to make precise changes. Use a small cross-point screwdriver, turning clockwise for darker print and counterclockwise for lighter print.

*NOTE: The **PRINT** potentiometer adjustment will affect the darkness in all of the command code speed ranges, i.e. if the **PRINT** potentiometer is adjusted for lighter print, the darkness will be lighter in all speed ranges selected by the command code.*

Print Speed

The other method of controlling print quality is by controlling the speed at which the label is printed. This adjustment is made only on an individual label basis using the Print Speed command code. For more details on this command, see Section 4, Programming. Changing the print speed allows the user to control the amount of time allowed for print element cooling before the media is stepped to the next print position. It is especially critical when printing “ladder” bar codes (bar codes printed with the bars parallel to the print line). When printing a “ladder” bar code, it is important to allow the head to cool sufficiently before stepping to the next position. If it does not have sufficient time to cool, the bar will be “smeared” on the trailing edge.

The Print Speed can be set using the LCD panel (see page 3-5) or with the Print Speed software command (see page 4-60). The software command will override the any setting entered using the LCD panel. The other method of controlling print quality is by controlling the speed at which the label is printed. This adjustment is made only on an individual label basis using the Print Speed command code. For more details on this command, see Section 5, Programming. Changing the print speed allows the user to control the amount of time allowed for print element cooling before the media is stepped to the next print position. It is especially critical when printing “ladder” bar codes (bar codes printed with the bars parallel to the print line). When printing a “ladder” bar code, it is important to allow the head to cool sufficiently before stepping to the next position. If it does not have sufficient time to cool, the bar will be “smeared” on the trailing edge.

CLEANING THE PRINT HEAD, PLATEN AND ROLLERS

Supplies needed: SATO SA070 Cleaning Kit

Cleaning the Print Head

1. Turn the printer off.
2. Open the **Label Access** door.
3. Open the **Print Head Assembly** by pushing the **Head Latch** toward the rear of the printer. The **Print Head Assembly** is spring-loaded and will automatically open as soon as the **Head Latch** is disengaged.
4. Apply SATO Thermal Print Head Cleaner to a cotton swab.

5. The **Print Head** faces downward along the front edge of the assembly. Pass the end of the dampened swab along the entire width of the **Print Head** (you may need to move the ribbon out of the way to do this).
5. Check for any black coloring or adhesive on the swab after cleaning.
6. Repeat if necessary until the swab is clean after it is passed over the head.
7. The head should be cleaned at least every time the ribbon is changed and more often in dusty environments.

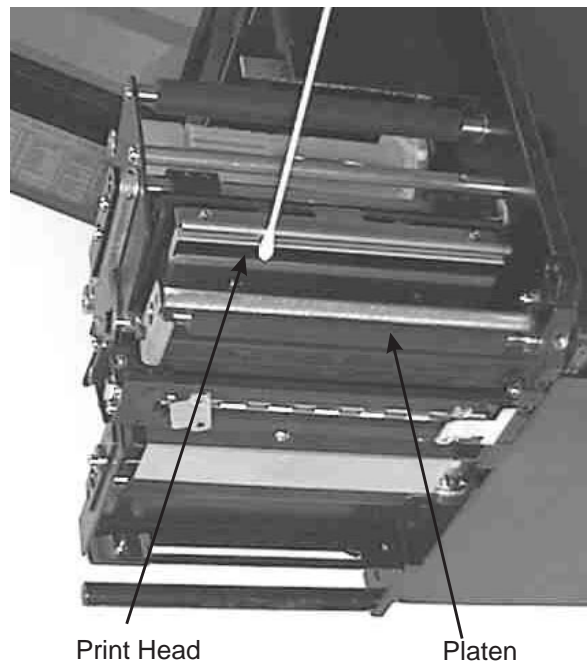

Cleaning the Platen and Rollers

1. Turn the printer off.
2. Open the label access door.
3. Open the **Print Head Assembly** by pushing the **Head Latch** toward the rear of the printer. The **Print Head Assembly** is spring-loaded and will automatically open as soon as the **Head Latch** is disengaged.

4. Apply SATO Thermal Print Head Cleaner to one of the cotton swabs.
5. The **Platen** is the rubber roller directly below the **Print Head**. It should be cleaned of any ribbon or label residue.

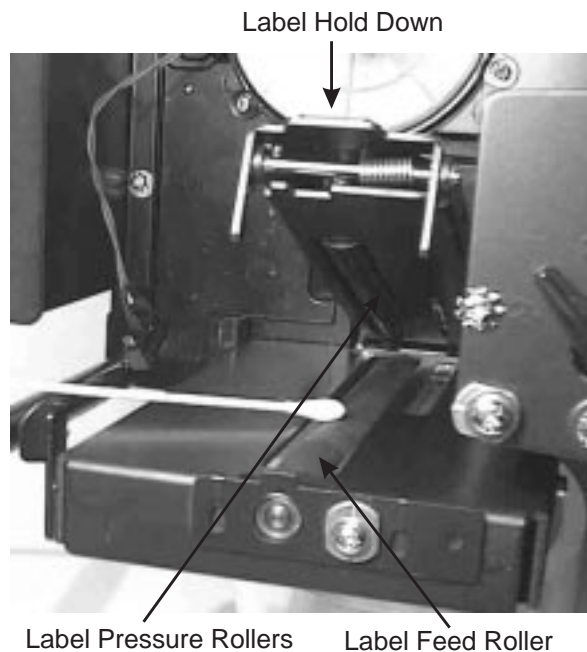

6. The **Label Feed Roller** is located underneath the **Label Hold-Down**. It should be cleaned of any label residue or foreign material. Clean the **Label Pressure Rollers** on the underside of the **Label Hold-Down**.
7. There is one metal **Ribbon Guide Roller** used in guiding the ribbon through the printer. It should be cleaned of any residue or foreign material.
8. Repeat if necessary. The platen and rollers should be cleaned whenever foreign matter such as dust or adhesive is present.

CLEANING THE SENSORS AND PAPER END SWITCH

There are two sensors that are used to control the positioning of the label. One is a transmissive see-thru sensor that detects the edge of the label by looking through the backing paper which is translucent and detecting the presence of the opaque label. The other is a reflective sensor that detects the light reflected from the bottom of the label liner. When a printed black Eye-Mark passes through the beam, the light is no longer reflected back to the sensor detector, indicating to the printer that it should use this position as the start of a new label. When dust, dirt, adhesive or other foreign matter interferes with the light path of either of these sensors, the results is erratic label positioning. These sensors should be cleaned regularly, at least every two rolls of labels. The **Paper End Switch** is located in front of the sensor window and should be periodically checked for residue on the actuator roller.

Supplies Needed: SATO SA070 Cleaning Kit

1. Turn the printer off.
2. Open the label access door.
3. Open the **Label Hold-Down** by disengaging the latch. The **Label Hold-Down** is spring loaded and will stay in the up position. The **Upper Sensor** will be visible on the underside of the **Label Hold-Down** when it is raised. It is adjustable over a range of 0.5" (14 mm) to 2.67" (68mm) from the inside edge of the label. The **Sensor Window** is positioned directly below the **Upper Sensor**.
4. Apply SATO Thermal Print Head Cleaner to one of the cotton swabs.
5. Use the cotton swab to clean any foreign matter from the exposed surface of the sensors.
6. Check the roller on the **Paper End Switch** for residue and clean if necessary.

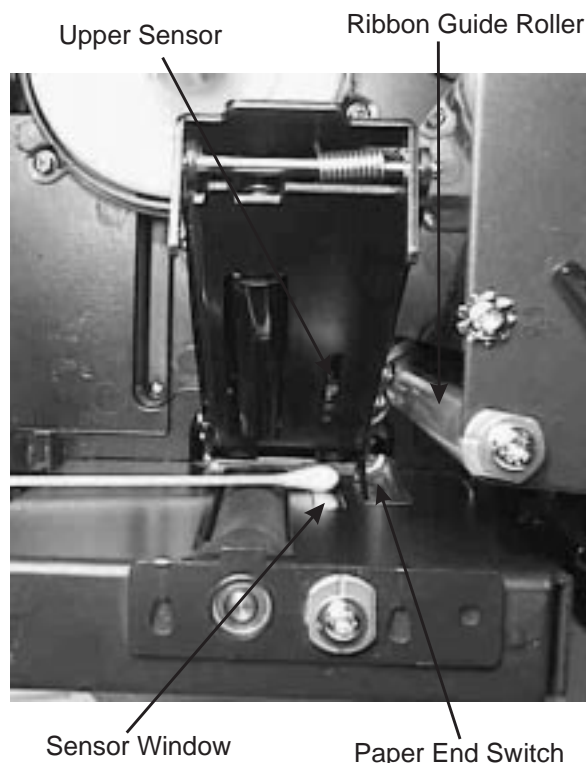

REPLACING THE PRINT HEAD

The print head is a user-replaceable item. If it becomes damaged for any reason, it can be easily removed and replaced. Contact your local SATO representative for information on obtaining a new print head.

Supplies needed: Flat Blade Screwdriver (Note: Some units may require a No. 2 Phillips screwdriver)

1. Turn the printer off and remove the power cable.
2. Open the **Label Access** door.
3. View the **Print Head Assembly** from the front of the printer. Locate the center mounting screw on the top of the assembly. (*Do not take out the two outside alignment screws!*) It is accessible through the center hole in the **Top Assembly Plate**. Remove this screw and set it aside.
4. Open the **Print Head Assembly** by pushing the **Head Latch** toward the rear of the printer. The **Print Head Assembly** is spring-loaded and will automatically open as soon as the **Head Latch** is disengaged.
5. Remove the ribbon from the **Rewind Spindle** if necessary.
6. The **Print Head** should now be loosened from the top of the assembly by grasping either side and carefully pulling it down and forward.
7. Disconnect the signal and power cables from the print head connectors and set the **Print Head** aside.
8. Carefully attach the new print head to the connectors, using caution to make sure the connector keys are correctly positioned.

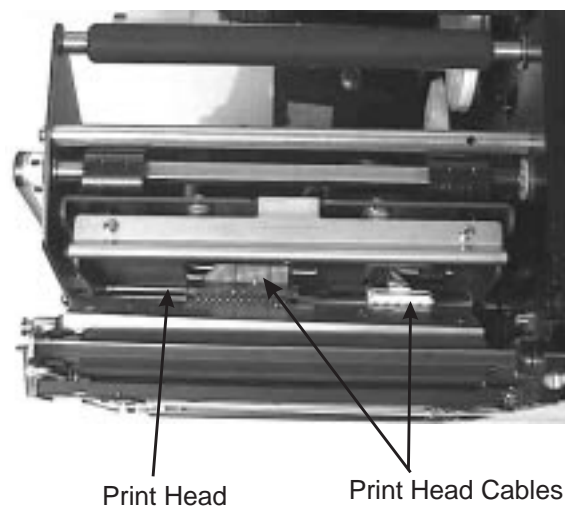
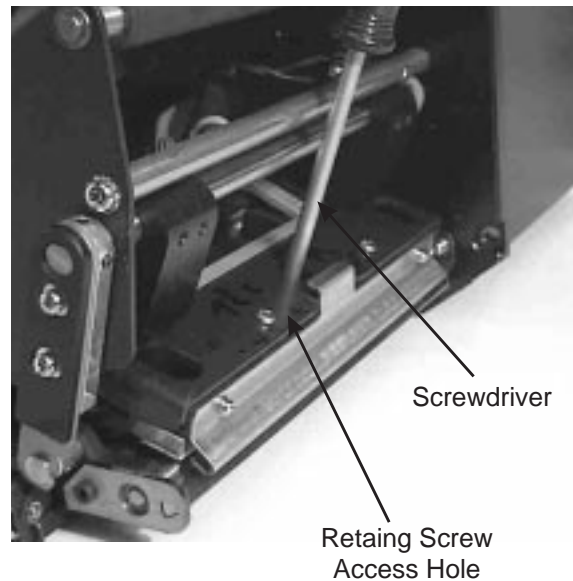

NOTE: Be careful not to scratch the printing surface of the print head while installing it. Scratching the surface will cause permanent and irreparable damage and is not covered by the warranty!

9. Locate the mounting screw in the top plate assembly and align it with the tapped hole in the new print head.
10. Re-secure the print head by tightening the screw.

REPLACING THE FUSE

Supplies needed: 250V 15A Fuse

1. Turn the printer power off and remove the power cable.
2. On the back of the printer, locate the **Fuse Cap** directly above the AC connector.
3. Unscrew the cap and remove the defective fuse.
4. Replace with a new 250V 15A fuse.
5. Screw the fuse cap back onto the printer and replace the power cable.

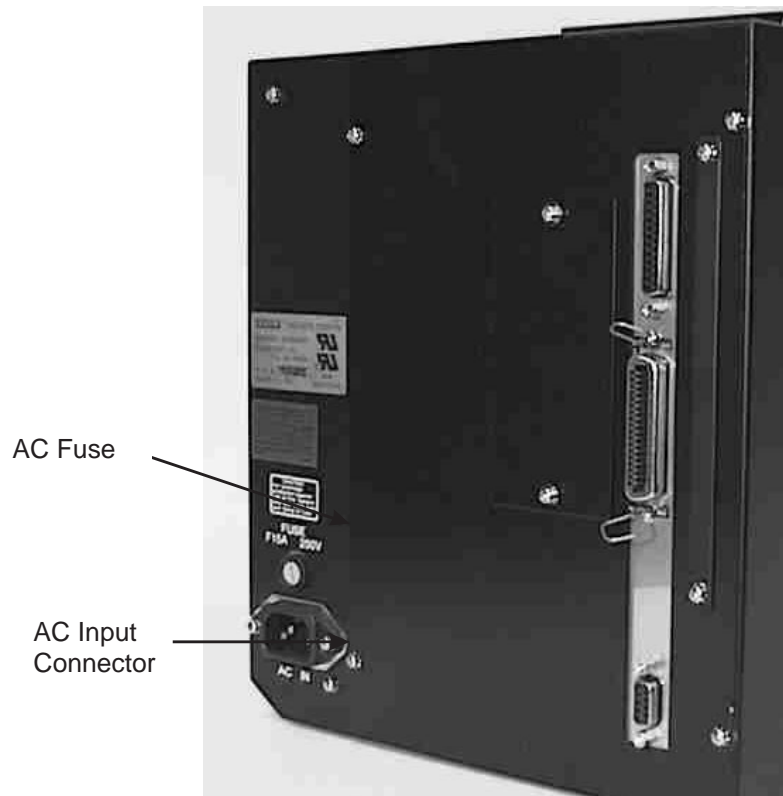

SECTION 5. PROGRAMMING

INTRODUCTION

This section presents the commands that are used with the SATO “S” printers to produce labels with logos, bar codes and alphanumeric data.

The following information is presented in this section:

- The SATO Programming Language
- Selecting Protocol Control Codes
- Using Basic
- The Print Area
- Command Codes

THE SATO PROGRAMMING LANGUAGE

A programming language for a printer is a familiar concept to most programmers. It is a group of commands that are designed to use the internal intelligence of the printer. The commands, which are referred to as SATO Command Codes, contain non-printable ASCII characters (such as <STX>, <ETX>, <ESC>) and printable characters. These commands must be assembled into an organized block of code to be sent as one data stream to the printer, which in turn interprets the command codes and generates the desired label output. The programmer is free to use any programming language available to send the desired data to the printer.

The command codes used are based upon “Escape” (1B hexadecimal) sequences. Typically there are four types of command sequences:

<ESC>{Command}

These commands generally tell the printer to perform a specific action, like “clear the memory.”

<ESC>{Command} {Data}

Commands with this format tell the printer to perform a specific action which is dependent upon the following data, like “print X labels”, where the value for X is contained in the data.

<ESC>{Command} {Parameter}

These commands set the operational parameters of the printer, like “set the print speed to 3.”

<ESC> {Command} {Parameter} {Data}

Some commands can contain both Parameter and Data elements, such as “print a Code 39 symbol containing the data.”

SELECTING PROTOCOL CONTROL CODES

Protocol codes are the special control characters that prepare the printer to receive instructions. For example, the **<ESC>** character tells the printer that a command code will follow and the **<ENQ>** character asks for the printer status.

There are two different sets of Protocol Control codes to choose from on the printer. Each set is made up of six special characters. The Standard Protocol Control codes are non-printable characters, and the Non-Standard Protocol Control codes are printable characters. The Non-Standard set may be useful on host computers using protocol converters or in an application where non-printable ASCII characters cannot be sent from the host. This manual uses the Standard Protocol Control codes for all of the examples.

The Protocol Control codes are selected by a DIP switch DSW2-7 on the front panel. See Section 3: Printer Configuration.

CONTROL CHARACTER	STANDARD DSW2-7 OFF	NON-STANDARD DSW2-7 ON	DESCRIPTION
STX	02 Hex	7B Hex = {	Start of Data
ETX	03 Hex	7D Hex = }	End of Data
ESC	1B Hex	5E Hex = ^	Command code to follow
ENQ	05 Hex	40 Hex = @	Get printer status, Bi-Com mode
CAN	18 Hex	21 Hex = !	Cancel print job, Bi-Com mode
Off-Line	40 Hex	5D Hex =]	Take printer Off-Line

USING BASIC

It may be useful to test your printer using a BASIC program on a PC. You may also write your actual production programs in BASIC. Whatever the reason, if you will be working in BASIC, some of the following hints may help you get started:

1. Set the WIDTH of the output device to 255 characters to avoid automatically sending **<CR>** and **<LF>** characters after every line. The command string should be continuous and uninterrupted by **<CR>** and/or **<LF>** commands. The examples given in this manual are printed on separate lines because they will not fit on one line and do not contain any **<CR>** and/or **<LF>** characters. If these characters are needed, they are explicitly noted by the inclusion of **<CR>** and **<LF>** notations.
2. If you are using the printer's RS232 interface, it is necessary to set the COM port on the PC such that the CTS and DSR signals will be ignored. Send your OPEN “COM” statement in the following way:

OPEN "COM1:9600,E,8,1,CS,DS" AS #1

This sets the RS232 communication parameters of the host PC's COM1 port for 9600 baud, Even parity, 8 Data bits, 1 Stop bit and directing the port to ignore the **CTS** and **DSR** control signals.

3. You may want to minimize keystrokes and program size by assigning the **<ESC>** character to a string variable since this character is used quite often.

The following two examples in BASIC show a typical example using these hints. Both of these examples use the Standard Protocol codes.

Printing with the Parallel Port

5 REM Parallel Example	Identifies the program as a parallel port print label. The "REM" prevents this data from being sent to the printer and displays it only on the screen.
10 E\$=CHR\$(27);	Sets the "E\$" string as an <ESC> character
20 WIDTH "LPT1:",255	Sets the width of the output to 255 characters
30 LPRINT E\$;"A";	Sends an "<ESC>A" command code to the LPT1 parallel port
40 LPRINT E\$;"H400",E\$;"V100";E\$;"WL1SATO";	Sends the data "SATO" to be to be placed 400 dots horizontally and 100 dots vertically on the label and printed in the "WL" font.
50 LPRINT E\$;"Q1";	Instructs the printer to print one label.
60 LPRINT E\$;"Z";	Tells the printer that the last command has been sent. The printer can now create and print the job.

Printing with the RS232 Port

5 REM RS232 Example	Identifies the program as a RS232 port print label. The "REM" prevents this data from being sent to the printer and displays it only on the screen.
10 E\$=CHR\$(27);	Sets the "E\$" string as an <ESC> character.
20 OPEN "COM1:9600,N,8,1,CS,DS" AS #1	Opens the COM1 port for output and sets the parameters as 9600 baud, No parity, 8 Data bits, 1 Stop bit and instructs the port to ignore the CTS and DSR control signals.
30 PRINT #1,CHR\$(2);	Sends an <STX> (ASCII Code a decimal "2") to the printer instructing it to prepare to receive a message.
50 PRINT #1,E\$;"A";	Sends an "<ESC>A" command code to Print Port #1 opened by statement 20 above.

- 60 PRINT #1, E\$;"H400",E\$;"V100";E\$;"WL1SATO"; Sends the data "SATO" to be to be placed 400 dots horizontally and 100 dots vertically on the label and printed in the "WL" autosmoothed font.
- 70 PRINT #1, E\$;"Q1"; Instructs the printer to print a quantity of one label.
- 80 PRINT #1, E\$; "Z"; Tells the printer that the last command has been sent. The printer can now create and print the job.
- 90 PRINT #1,CHR\$(3); Sends an <ETX> (ASCII Code decimal "3") to the printer telling it that this is the end of the message.

THE PRINT AREA

The maximum print area depends upon the printer model (see the table on page 2-9). The length for both printers is 7 inches long in the standard mode and 14 inches long if the pitch area is expanded with the Expanded Print Length command. The maximum length can be extended to 49.2 inches for the all printers but the M-8490S and 32.8 inches for the M-8490S with the installation of additional memory. Most of your label applications will not require labels this large, therefore, it is important to understand how to work with labels that do not use the entire print area. The goal is to help you avoid printing where no label exists, which may lead to print head damage, not to mention the frustration when you cannot see the printed output.

The diagram below illustrates the print area for a standard (Right-Hand) M-8485S and a sample 2 inch wide by 3 inch long label placed within this area. As can be seen, your label will be oriented against the inside right edge of the printer as viewed from the front (label exit) of the printer. If you are using an M-8485S Left-Hand printer, the reference point is on the outside edge of the label away from the mounting plate.

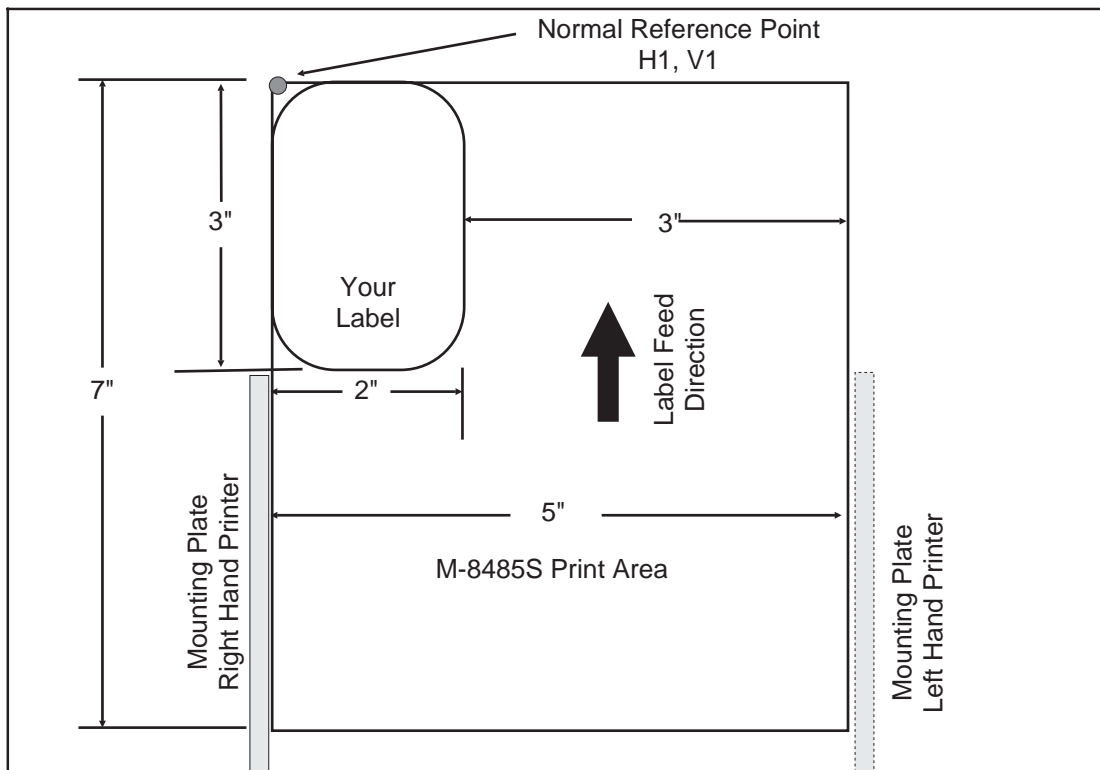

The normal reference point is located at the H1, V1 position of the print area in the normal print orientation (no rotation).

The base refernece point is always on the right edge of the print head as you face the front (label exit) of the printer. If you are using a label that is narrower than the maximum print width, you may have to adjust the base reference point of the Left-Hand printer to correctly position the print area. If you are using a Left-Hand M-8485S and ned to adjust the position of the label, there are two methods available. They are as follows:

1. Send the Base Reference Point command as part of your data to the printer to set a new base reference point for your label.

Calculate the distance (in dots) that corresponds to the amount you wish to shift the label print area. If you wanted to move the print area over to the left (as viewed from the front or label exit end of the printer) 3.0 inches:

$$\text{Shift Distance} = 3.0" \times 25.4 \text{ mm/in} \times 8 \text{ dpmm} = 610 \text{ dots}$$

$$\text{New Base Reference Point} = 610 \text{ dots}$$

Issue the Base Reference Point command after the Start command in your data stream.

`<ESC>A3H0610V0001`

This resets the reference point for all the following data.

Note: After the reference point is moved, you can no longer print on the 610 dot "margin" unless the reference point is reset.

2. Use the normal base reference point from the print area and use the horizontal position for each field to properly locate it on the label.

Calculate the distance (in dots) from the normal base reference point to the closest edge of the label.

$$\text{Shift Distance} = 3.0" \times 25.4 \text{ mm/in} \times 8 \text{ dpmm} = 610 \text{ dots}$$

Each `<ESC>H` command would have the value "610" added to it to correctly position each field.

The Command Code subsection contains a sample label output for each command code. These samples reflect how the printed information would appear on a five inch wide label (see illustration). If you want to test any of the sample label outputs and are using labels less than five inches in width, you will have to adjust the positioning accordingly so that the printer does not try to print where there is no label.

You must be careful not to print off the label surface as the label provides a heat sink for the print head elements. Doing so will cause irreparable damage to the head. This damage is not covered under the print head warranty.

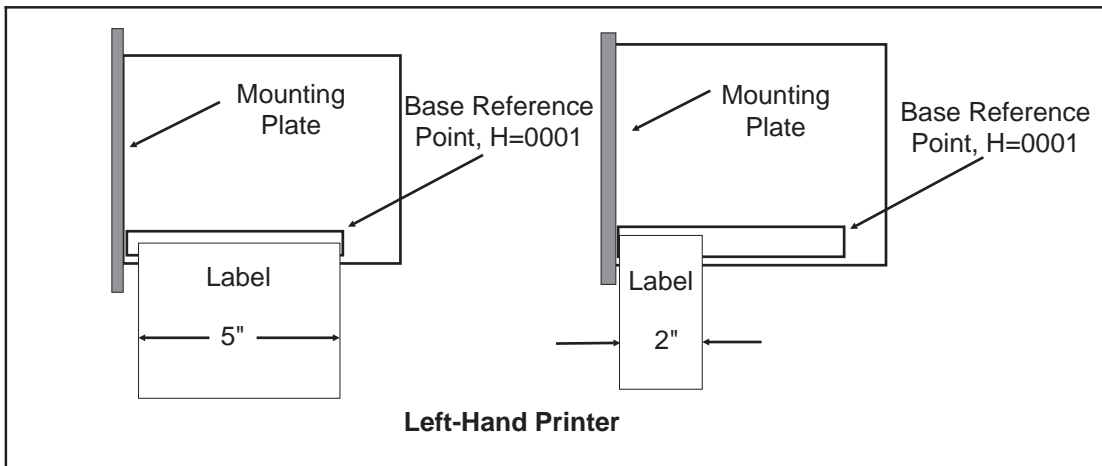

For example, the following illustrates a sample data stream and the resulting label assuming a five inch wide label on a left-hand model printer:

```
<ESC>A
<ESC>H0050<ESC>V0100<ESC>L0303<ESC>MSATO
<ESC>H0050<ESC>V0200<ESC>B103100*SATO*
<ESC>H0070<ESC>V0310<ESC>L0101<ESC>USATO
<ESC>Q1<ESC>Z
```

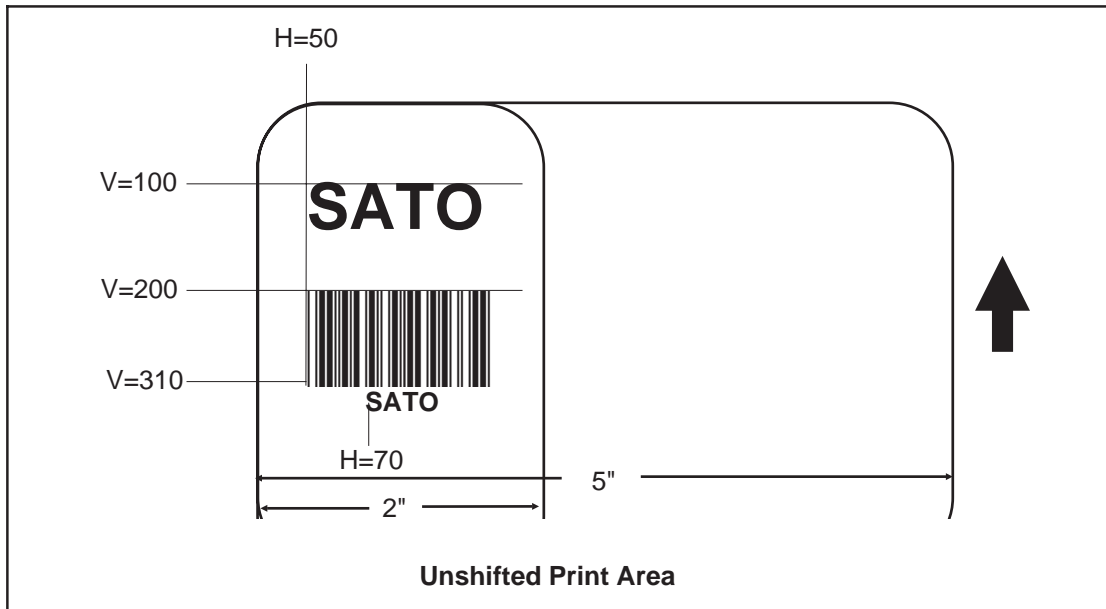

If you are using a two inch wide label, the entire image may not appear on your label. By adding the following Base Reference Point command to the second line of the data stream, the base reference point will be changed, causing the image to be shifted over toward the inside of the printer where it can be printed on the narrower label.

```
<ESC>A
<ESC>A3H0610V0001
<ESC>H0050<ESC>V0100<ESC>L0303<ESC>MSATO
<ESC>H0050<ESC>V0200<ESC>B103100*SATO*
<ESC>H0170<ESC>V0310<ESC>L0101<ESC>USATO
<ESC>Q1<ESC>Z
```

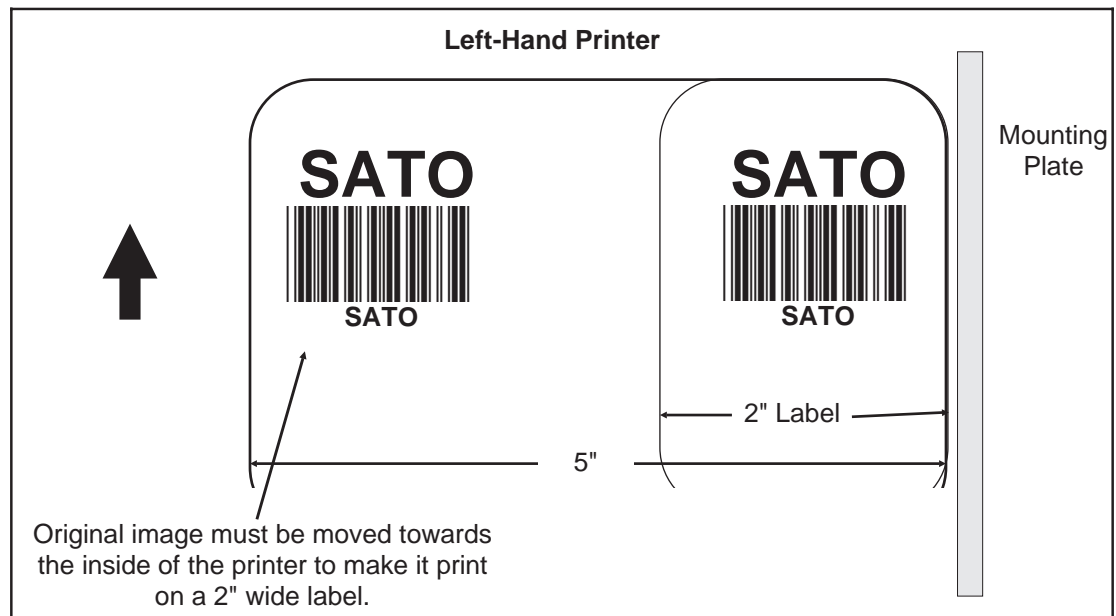

The image reference point is set at the right edge (edge closest to the printer side plate) of the label so that it can be printed on a 2 inch wide label.

Note: The printers will not “wrap” images that extend beyond the print area. If any part of a character or image extends beyond the print area, it will disappear.

For more information, see the Base Reference Point command description.

ROTATED FIELDS

The printers can rotate each print field in 90° increments using the Rotate command. There are two variations of this command.

- **<ESC>%** - The field rotates, but the base reference point for the field remains the same.
- **<ESC>R** - The field *and* the base reference point rotate.

The following data stream will rotate the print field but will not change the base reference point of the field:

```
<ESC>A<ESC>%1<ESC>V800<ESC>H200<ESC>L0202<ESC>WB1E<ESC>Q1<ESC>Z
```

The following data stream will rotate both the field and the base reference point for that field:

```
<ESC>A<ESC>R<ESC>V0200<ESC>H0100<ESC>L0202<ESC>P02<ESC>WB1E<ESC>Q1<ESC>Z
```

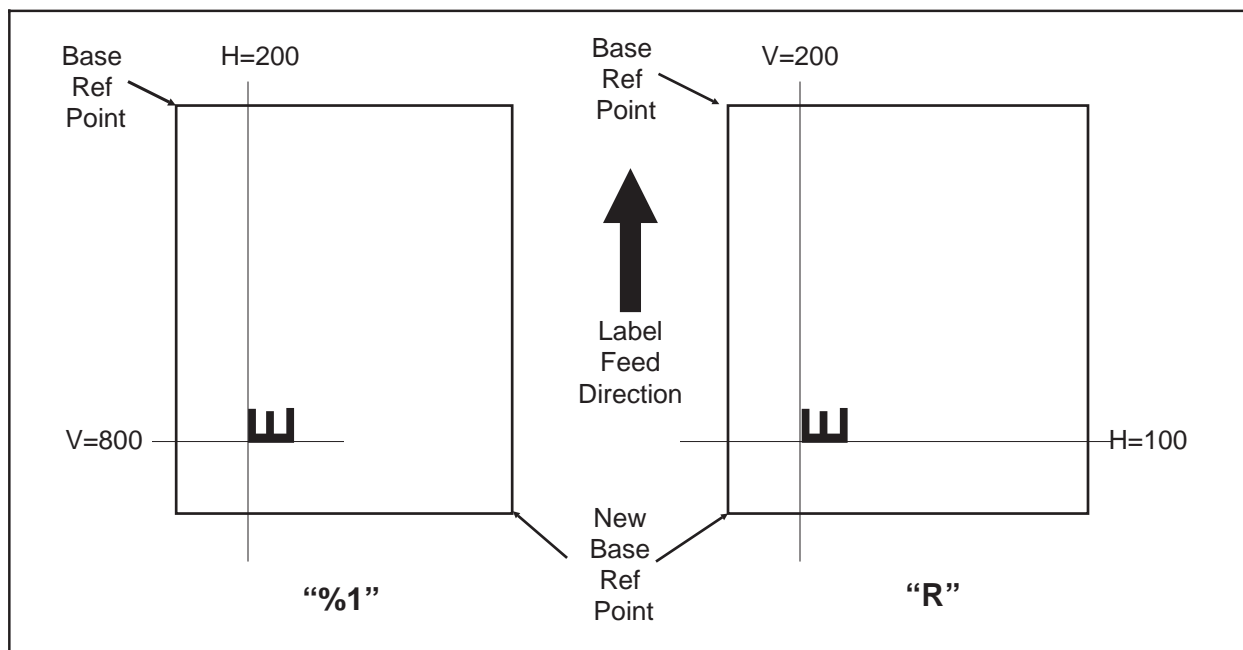

COMMAND DEFAULT SETTINGS

There are some types of commands that must have a value specified before a label can be printed. If the data stream does not contain these commands, a “default” value is assumed. The commands and the corresponding default values are:

COMMAND	DEFAULT	NOTE
Print Rotation	0°	(1)
Vertical Reference Point	0	(1)
Horizontal Reference Point	0	(1)
Character Pitch	2	(1)
Base Reference Point	H=1, V=1	(2)
Character Expansion	1	(1)
Print Darkness	2	(1)
Print Darkness (M-8459S)	3	(1)
Print Speed	6 ips	(2)
Print Speed (M-8459S)	4 ips	(2)

NOTES:

- (1) The settings for these commands will revert to the default value when the printer receives an <ESC>Z or an <ESC>*.
- (2) These values transmitted with these commands will remain in effect until a new command is received.

OPPOSITE HAND MODELS

The standard M-8485S is referred to as a “right-hand” printer (i.e., when facing the Control Panel, the label comes out from left to right). The M-8485S is also available in a “left-hand” (i.e., the labels comes out right to left) version.

The only difference in the print area is the horizontal base reference point for the label. With the standard M-8485S, the reference point is the first print position nearest the inside frame. With the “left-hand” version, the reference point is the first print position away from the frame. The same command stream sent to both printers should print an identical label except the image may be shifted because of the relative positioning of the label under the print head.

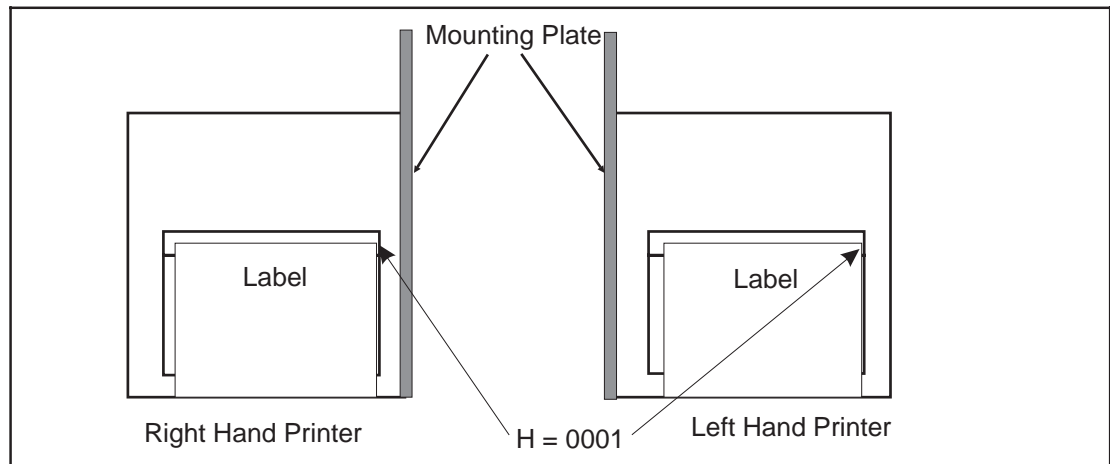

The M-8459S, M-8460S and M-8490S are only available in “right-hand” versions.



M-8485S Left-Hand

COMMAND CODE PAGE REFERENCE

This section contains all the printer Command Codes. The commands must be sent to the printer in an organized fashion in order for the label(s) to print.

The purpose of this section is to:

1. Explain the different commands and provide examples of their usage.
2. To provide a detailed reference for programming.

Each command begins on a separate page with its own heading. A uniform layout is used to help you find key information about each command. For each Command Code in this section, there will be a sample data input stream to the printer and the expected print output. By studying the examples, you can learn how to use the particular command within a whole block of printer code. Pay particular attention to the “Special Notes” with each command to learn other important information.

The subject commands are highlighted in bold letters in the Reference Sheets. There are two parts of most, but not all, commands. The first is the command character which immediately follows the <ESC> code. It is always an upper case alpha or a special character (such as an “&” or a “%”). It is never a lower case alpha character. If the command requires additional variable information, it is represented by a group of lower case alpha characters immediately following the command character. For example, if an **aaaabb** is listed following the basic command, the printer will look for six characters immediately following the command. The first four would represent the value of **aaaa** and the next two the value of **bb**.

The maximum number of characters defined in a parameter is represented by the number of characters shown in the command structure. For example, a command followed by an **aaaa** can have up to four characters. In general, commands with only one parameter following the command can be entered without the leading zeroes. In the above example, you could enter either “809” or “0809”. However, certain commands require the exact number of matching characters. A command with two parameters listed following the command code, such as **aaaabbbb** require the exact number of digits to be entered. If the value of **aaaa** is “800” and the value of **bbbb** is “300”, then the parameters must be entered as “08000300”. It is recommended that you make it a practice to always enter leading zeros to prevent any mistakes.

NOTE: These examples assume the use of the Standard Protocol Command Codes, with a Right-Hand version of the M-8485S printer with a parallel interface and a five inch wide label which is the maximum width that will fit in the printer. If the same command stream is sent to an M-8490S, the image will be reduced by 33%.

An alphabetical listing of the commands is contained in Appendix A: Command Code Quick Reference.

Bar Codes

Command Structure 1:3 narrow/wide bar ratio: <ESC>**Babbcccd**
2:5 narrow/wide ratio: <ESC>**BDabbcccd**
1:2 narrow/wide bar ratio: <ESC>**Dabbcccd**

- a = Bar Code Symbol
- 0 Codabar
 - 1 Code 39
 - 2 Interleaved 2 of 5 (I 2/5)
 - 3 UPC-A / EAN-13
 - 4 EAN-8
 - 5 Industrial 2 of 5
 - 6 Matrix 2 of 5
 - 7 reserved
 - 8 reserved
 - 9 reserved
 - A MSI
 - B reserved
 - C Code 93
 - D reserved
 - E UPC-E
 - F Bookland
 - G Code 128
 - I UCC 128
- bb = Number of dots (01-12) for narrow bar and narrow space
- ccc = Bar height in dots (001-600)
- d = UCC 128 only. Not used for other bar code types
- 0 No human readable text
 - 1 Human readable at top
 - 2 Human readable at bottom

Example: <ESC>**BD103200**

Placement: Immediately preceding data to be encoded

Default: None

Command Function To print bar code images on a label. With this command, there are 13 standard bar code symbologies available to be printed and three two dimensional symbols (see Two Dimensional bar code symbols starting on page 5-95). Each of the bar codes are unique, and it is important to know the differences. See Appendix B for specific information on using each individual bar code symbol.

Input to Printer

```

<ESC>A
<ESC>H0025<ESC>V0025<ESC>B103100*CODE 39*
<ESC>H0155<ESC>V0130<ESC>XS*CODE 39*
<ESC>H0025<ESC>V0200<ESC>BD20210045676567
<ESC>H0075<ESC>V0310<ESC>XM45676567
<ESC>H0025<ESC>V0375<ESC>BD30215001234567890
<ESC>H0025<ESC>V0600<ESC>BD50210012345
<ESC>H0175<ESC>V0710<ESC>XS12345
<ESC>H0025<ESC>V0775<ESC>BD60210012345
<ESC>H0105<ESC>V0885<ESC>XS12345
<ESC>H0025<ESC>V0950<ESC>BA03100123455
<ESC>H0095<ESC>V1060<ESC>XS12345
<ESC>H0025<ESC>V1125<ESC>BC03100081234ABCD
<ESC>H0080<ESC>V1240<ESC>XS1234ABCD
<ESC>H0525<ESC>V0025<ESC>B002100A12345B
<ESC>H0565<ESC>V0135<ESC>XS12345
<ESC>H0475<ESC>V0200<ESC>BD303100123456789012
<ESC>H0525<ESC>V0375<ESC>BD4031001234567
<ESC>H0525<ESC>V0550<ESC>DE03100123456
<ESC>H0500<ESC>V0600<ESC>OB0
<ESC>H0533<ESC>V0655<ESC>OB123456
<ESC>H0350<ESC>V0725<ESC>D30315009827721123
<ESC>L0101<ESC>H0320<ESC>V0800<ESC>OB0
<ESC>H0365<ESC>V0878<ESC>OB98277
<ESC>H0505<ESC>V0878<ESC>OB21123
<ESC>H0665<ESC>V0760<ESC>BF0313021826
<ESC>H0680<ESC>V0730<ESC>OB21826
<ESC>H0425<ESC>V1125<ESC>D30315000633895260
<ESC>L0101<ESC>H0395<ESC>V1200<ESC>OB0
<ESC>H0440<ESC>V1278<ESC>OB06338
<ESC>H0580<ESC>V1278<ESC>OB95260
<ESC>H0730<ESC>V1155<ESC>BF0314024
<ESC>H0745<ESC>V1125<ESC>OB24
<ESC>H0325<ESC>V0950<ESC>BG03100>GAB>B789>C123456
<ESC>H0435<ESC>V1055<ESC>XSAB789123456
<ESC>Q1<ESC>Z
  
```

Note: Carriage Returns and Line Feeds have been added to the command listing for clarity and should not be included in the actual data stream.

Printer Output

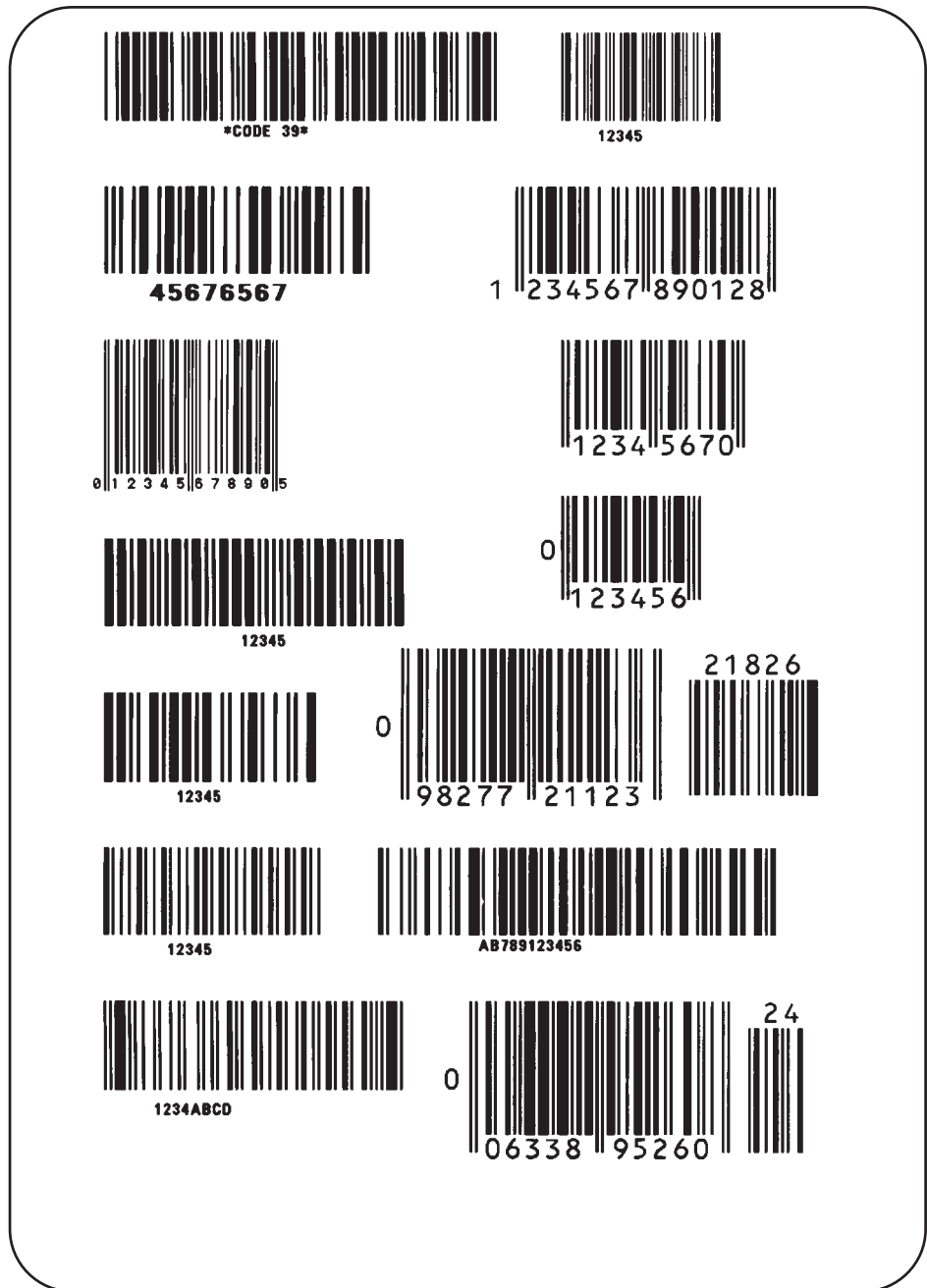

UCC-128

Without Incrementing

<ESC>A
<ESC>H0100<ESC>V0100<ESC>BI07150101234567000000001
<ESC>Q2<ESC>Z

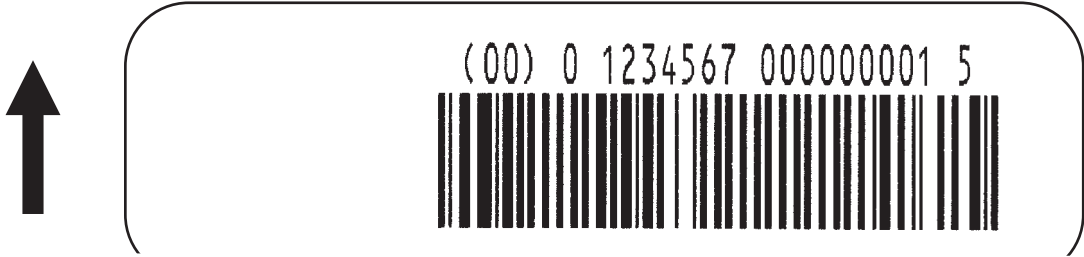

With Incrementing

<ESC>A
<ESC>H0100<ESC>V0100<ESC>F001+001<ESC>BI07150101234567000000001
<ESC>Q2<ESC>Z

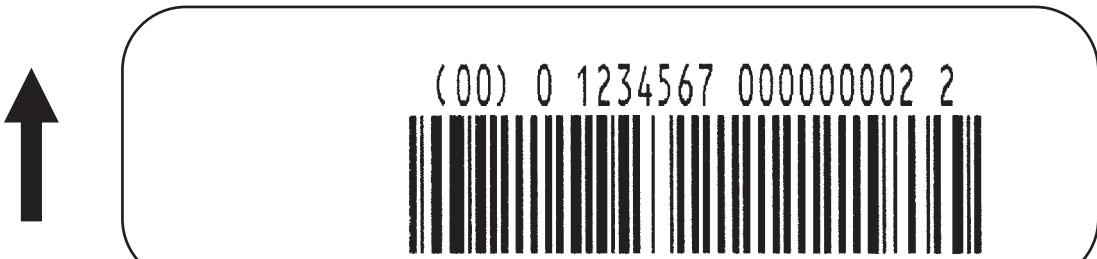

Special Notes

1. UPC and EAN bar codes are not affected by the different types of narrow to wide ratios. Instead, the <ESC>D command adds descender bars to these codes where needed to meet UPC specifications. The <ESC>BD command puts descender bars and human readable text below the symbol.
2. The Code 128, UCC 128, MSI, and Code 93 bar codes are not affected by the narrow to wide ratios.
3. The Codabar, Code 39, Industrial 2 of 5, and Matrix 2 of 5 bar codes are affected by the Character Pitch command. This command must be placed before the Bar Code command.
4. See Appendix B for more specific instructions and detailed information regarding individual bar code symbols.
5. Because of their unique characteristics, two-dimensional symbols are covered separately (see page 5-95).
6. For UCC128, the FNC1 code is automatically inserted and the Mod 10 and Mod 103 check digits are automatically calculated.
7. For the MSI bar code, the check digit is not automatically calculated.

Bar Codes, Expansion

Command Structure <ESC>**BW**aa**bbb**

aa = Expansion factor by which the width of all bars and spaces will be increased (01-12)

bbb = Bar height by dot (004-600 dots)

Example: <ESC>**BW02100**

Placement: Immediately follows the <ESC>BT command and precedes data to be encoded.

Default: None

Command Function This command works together with the <ESC>BT command to specify an expansion factor and the bar code height for the particular symbol being printed.

Input to Printer: <ESC>A
 <ESC>H0050<ESC>V0050<ESC>BT101030103
 <ESC>**BW04100*1234***
 <ESC>Q1<ESC>Z

Printer Output:



Special Notes

1. This command must be preceded by the Variable Ratio Bar Codes <ESC>BT command (see Page 5-17).
2. The following bar codes will be affected by the Character Pitch command: Codabar, Code 39, Interleaved 2 of 5, Matrix 2 of 5.

Bar Codes, Variable Ratio

Command Structure <ESC>**BT**abbccddee

a = Bar Code Symbol:
0 Codabar
1 Code 39
2 Interleaved 2 of 5
5 Industrial 2 of 5
6 Matrix 2 of 5

bb = Narrow space in dots (01-99)
cc = Wide space in dots (01-99)
dd = Narrow bar in dots (01-99)
ee = Wide bar in dots (01-99)

Example: <ESC>**BT**101030103

Placement: Following print position commands and preceding
 <ESC>**BW**

Default: Current setting

Command Function To print a bar code with a ratio other than those specified through the standard bar code commands (B,BD, and D). This is done through individual control of each of the bar code elements (bars, spaces) as shown above. Remember that this command only applies to the five bar code types shown.

Input to Printer: <ESC>A
 <ESC>H0050<ESC>V0050<ESC>**BT101030103**
 <ESC>**BW**03100*1234*
 <ESC>Q1<ESC>Z

Printer Output:



Special Notes

1. This command must be immediately followed by the <ESC>BW Bar Code Expansion command (see Page 5-16).
2. You may use only one variable ratio bar code per label.
3. If the data specified in this command is incorrect, the command is ignored and the ratio used will be based on the previous setting.
4. See Appendix B for more specific instructions and details regarding individual bar code symbols.

Base Reference Point

Command Structure <ESC>A3H-aaaaVbbbb

- = This character is optional. When present, it specifies that the horizontal offset is in the negative direction. If it is left out the offset direction is positive.

aaaa = Horizontal Print Offset (see Note 7 for field range)

bbbb = Vertical Print Offset (see Note 7 for field range)

Example: <ESC>A3H100V0050

Placement: Preceding all images that are based on the new base reference point

Default: Current V and H offset setting in the printer configuration

Command Function To establish a new base reference point for the current label. The base reference point is the top left corner or “origin” from where all print position commands are based.

This command may be very helpful when using labels less than four inches wide to place images on the printable label surface. It may also be used to move images past preprinted fields on a label.

Input to Printer: <ESC>A<ESC>L0202
 <ESC>H0025<ESC>V0025<ESC>WB0MNORMAL REFERENCE POINT
 <ESC>A3H0300V0075
 <ESC>H0100<ESC>V0050<ESC>WB0MNEW REFERENCE POINT
 <ESC>Q1<ESC>Z

Printer Output:

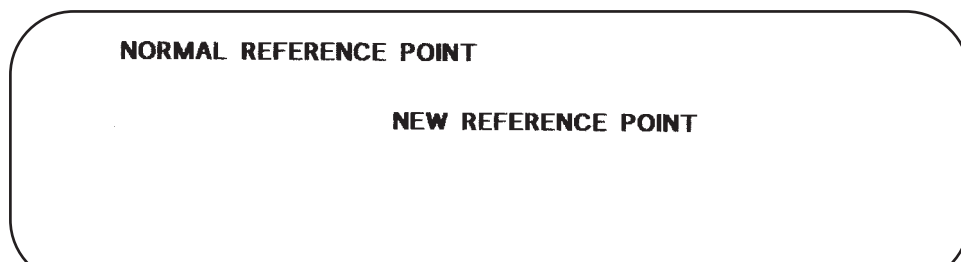

Special Notes

1. Use of this command will set the Vertical/Horizontal Offset setting of the printer configuration until a new Base Reference Point command is issued or the setting is changed from the operator panel. See Section 2: Printer Configuration.
2. This command may be used more than once in a print job.
3. An alternative to using this command is to make changes to your current Horizontal and Vertical Print Position commands (see Page 5-20).

Example:

Let's say the current base reference point is H=1, V=1 and you wish to move all the fields on your label downward vertically by 150 dots. You could either (1) add the Base Reference Point command or (2) change all the vertical position commands by an additional 150 dots.

4. For a more detailed example of the Base Reference Point command, see "Print Area" in this section (Page 5-4).
5. The "S" print engines can print as close as 2mm to the inside edge of the label.
6. The "S" print engines will not "wrap" (i.e. if any part of a character or image extends beyond the last print dot position, it will disappear and not be visible on any part of the label).
7. The allowable field ranges for this command are:

	M-8459S	M-8460S	M-8485S	M-8490S
Horizontal aaaa	-896 to 896	-1216 to 1216	-1024 to 1024	-1344 to 1344
Vertical bbbb	0001 to 1424	0001 to 1424	0001 to 1424	0001 to 2136

Characters, Custom-Designed

Command Structure

Store Command: <ESC>**Tabcc**
Recall Command: <ESC>**Kab90cc**

a = 1 16x16 matrix
2 24x24 matrix

b = Specifies the character encoding method for the data stream
H Hexadecimal characters
B Binary characters

cc = Memory location to store/recall the character. Valid memory locations are 21 to 52 (counting in Hex) or “!” to “R” in Binary

(data) = Data to describe the character

Example: <ESC>**T1H3F**
<ESC>**K1H903F**
See Appendix C for a more detailed explanation

Placement: The Store command is typically sent in its own data stream to the printer, between the Start/Stop commands. The Recall command is sent in a secondary data stream to print the character, and follows any necessary position or size commands.

Default: None

Command Function

To allow for the creation, storage, and printing of custom characters, such as special fonts or logos. Up to 50 individual characters may be stored in the custom character volatile memory.

Printer Input

See Appendix C for a detailed explanation.

<ESC>A
<ESC>**T1H3F**
0100038007C00FE01FF03FF87FFCFFFE07C007C007C007C007C007C007C0
<ESC>Z

<ESC>A
<ESC>H150<ESC>V100<ESC>L0505<ESC>**K1H903F**
<ESC>H350<ESC>V100<ESC>L1010<ESC>**K1H903F**
<ESC>Q1<ESC>Z

Printer Output

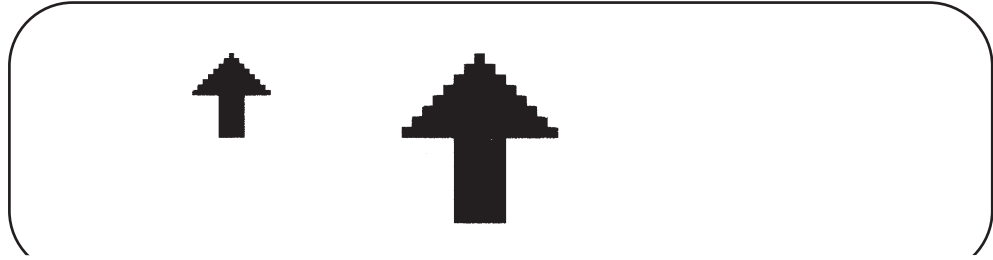

Special Notes

1. When printing the custom character using the Recall command, the character is affected by the following commands:
 - Character Expansion (see Page 5-23)
 - Character Pitch (see Page 5-26)
 - Line Feed (see Page 5-49)
 - Rotate, Fixed Base Reference Point (see Page 5-64)
 - Rotate, Moving Base Reference Point (see Page 5-66)
2. The characters are stored in volatile memory and must be reloaded if the printer power is lost.
3. Do not use ASCII <CR> or <LF> characters (carriage return or line feed) as line delimiters within the graphic data or the actual image will not be printed as specified.

Character Expansion

Command Structure <ESC>Laabb

aa = Multiple to expand horizontally (01-12)

bb = Multiple to expand vertically (01-12)

Example: <ESC>L0305

Placement: Preceding the data to be expanded

Default: <ESC>L0101

Command Function To expand characters independently in both the horizontal and vertical directions. The command allows you to enlarge the base size of each font (except the vector font) up to 12 times in either direction. Expanded characters are typically used for added emphasis or for long distance readability.

Input to Printer <ESC>A<ESC>H0100<ESC>V0100<ESC>XMSATO
<ESC>H0100<ESC>V0200<ESC>**L0402**<ESC>XMSATO
<ESC>H0100<ESC>V0300<ESC>**L0204**<ESC>XMSATO
<ESC>Q1<ESC>Z

Printer Output



Special Notes

This command will expand the following fonts:

1. Fonts U, S, M, XU, XS, XM, OA & OB (see Page 5-33) and fonts WB, WL, XB and XL (see Page 5-36).
2. This command will also affect the following commands:
Character Pitch (see Page 5-26)
Characters, Custom-Designed (see Page 5-21)
3. The Character Expansion value is in effect for the current print job until a new expansion command is specified.
4. The Line and Box command, if used within the data stream, may return all subsequent text to the default expansion of 1 x 1. Therefore, either send the Character Expansion command before all printed data, or send Line and Box commands last, preceding the <ESC>Q Quantity command.

Character, Fixed Spacing

Command Structure <ESC>PR

Example: See Above

Placement: Preceding the data

Default: The default is Proportional Spacing.

Command Function To reset proportional spacing and place the printer back to fixed spacing.

Printer Input

```
<ESC>A  
<ESC>H0100<ESC>V0050<ESC>PS  
<ESC>L0404<ESC>XMPROPORTIONAL SPACING  
<ESC>H0100<ESC>V0180<ESC>PR  
<ESC>L0404<ESC>XMFIXED SPACING  
<ESC>Q1<ESC>Z
```

Printer Output



PROPORTIONAL SPACING
FIXED SPACING

Special Notes

1. This command only works with the proportionally spaced fonts XU, XM, XS, XL and XB.

Character Pitch

Command Structure <ESC>Paa

aa = Number of dots between characters (00-99)

Example: <ESC>P03

Placement: Preceding the text to be printed

Default: <ESC>P02

Command Function To designate the amount of spacing (in dots) between characters. This command provides a means of altering character spacing for label constraints or to enhance readability.

Input to Printer: <ESC>A
 <ESC>H0025<ESC>V0025<ESC>L0202<ESC>XB1SATO
 <ESC>H0025<ESC>V0125<ESC>L0202<ESC>P20<ESC>XB1SATO
 <ESC>H0025<ESC>V0225<ESC>L0202<ESC>P40<ESC>XB1SATO
 <ESC>Q1<ESC>Z

Printer Output:



SATO
S A T O
S A T O

Special Notes

1. This command is affected by the <ESC>L Character Expansion command (see Page 5-23). The character pitch is actually the product of the current horizontal expansion multiple and the designated pitch value.

Example:

<ESC>L0304

<ESC>P03

Pitch = (03) x (03) = 9 dots

2. To avoid confusion, you may want to include the <ESC>L Character Expansion command and this command together in your program.
3. This command affects fonts U, S, M, XU, XS, XM, OA & OB (see Page 5-33 fonts WB, WL, XB and XL (see Page 5-37), and the vector font (see Page 5-35).
4. Character Pitch will always revert to the default value unless it is specified before each new font command in the data stream.
5. This command also affects Codabar, Code 39 and Industrial 2 of 5 bar codes.

Character, Proportional Spacing

Command Structure	<p><ESC>PS Set to proportional spacing</p> <p><ESC>PR Reset to fixed spacing</p>
Example:	See above
Placement:	Preceding the data to be proportional spaced
Default:	<ESC> PS

Command Function To specify the printing of proportional or fixed spacing for proportionally spaced fonts.

Printer Input

```
<ESC>A
<ESC>H0025<ESC>V0050<ESC>PS
<ESC>L0202<ESC>XMPROPORTIONAL SPACING
<ESC>H0025<ESC>V0130<ESC>PR
<ESC>L0202<ESC>XMFIXED SPACING
<ESC>Q1<ESC>Z
```

Printer Output



PROPORTIONAL SPACING

FIXED SPACING

Special Notes

1. Once this command is sent in the data stream, it is in effect until the end of the print job unless a reset command is sent.

Clear Print Job(s) & Memory

Command Structure	<ESC>*a
	a = If the “a” parameter is not included with this command and the printer is in the multi-buffer mode, this command clears all print jobs in the printer memory, including the current print job.
	a = If “a” is included with this command, it specifies the internal memory section to be cleared T To clear the custom character memory & To clear the form overlay memory X To clear all internal memory
	Example: <ESC>* <ESC>*&
	Placement: This command should be sent to the printer as an independent data stream.
	Default: None
Command Function	To clear individual memory or buffer areas of the printer.
Input to Printer:	<ESC>A <ESC>* <ESC>Z
Printer Output:	There is no printer output as a result of this command. The current print job in the buffer will be terminated and all other print jobs in the buffer cleared.
Special Note	<ol style="list-style-type: none">1. See Memory Card Functions for variations of this command used to clear data from the memory card (page 5-77).2. It is not necessary to clear the printer’s memory between each print job.3. The primary purpose of this command is to clear all print jobs in the multi-buffer mode. The “a” parameter can be used in either the multi-buffer or single job mode to clear specific parts of the memory.4. When the “a” parameter is used, the section of memory specified will not be cleared until the label is printed.

Continuous Forms Printing

Command Structure None

The printer locates the end of an adhesive label by sensing the backing between labels or through the use of an eye-mark (black rectangle on the reverse side of the backing). It locates the end of a tag from a notch, eye-mark, or a hole between tags. Both sensors should be disabled when printing continuous forms by placing the Label Sensor Selection switch (DSW3-3) in the ON position. See *Section 3: Printer Configuration* for instructions on configuring the printer using the front panel DIP switch array.

If you will be using continuous labels or tags, the printer must be told to stop feeding in another manner. The length is determined by the position of the last printed image on the label or tag. The printer will stop feeding when this last field is finished printing. The length may be increased with printed spaces (20 hexadecimal) if necessary. There is no command code to control label length.

Copy Image Area

Command Structure <ESC>**WDHaaaaVbbbbXccccYdddd**

aaaa = Horizontal position of the top left corner of the area to be copied

bbbb = Vertical position of the top left corner of the area to be copied

cccc = Horizontal length of the image area to be copied

dddd = Vertical length of the image area to be copied

Example: <ESC>**WDH0100V0050X0600Y0400**

Placement: Anywhere within the data stream, after specifying the location of the duplicate image.

Default: None

Command Function To copy an image from one location to another on the same label. This may be useful for duplicating individual fields or entire sections of the label with only one command.

Input to Printer: <ESC>A
<ESC>H0050<ESC>V0050<ESC>E010<ESC>XM
SATOSATOSATOSATOSATOSATO
SATOSATOSATOSATOSATOSATO
SATOSATOSATOSATOSATOSATO
SATOSATOSATOSATOSATOSATO
<ESC>H0180<ESC>V0250<ESC>**WDH0130V0050X0400Y0200**
<ESC>Q1<ESC>Z

Printer Output:

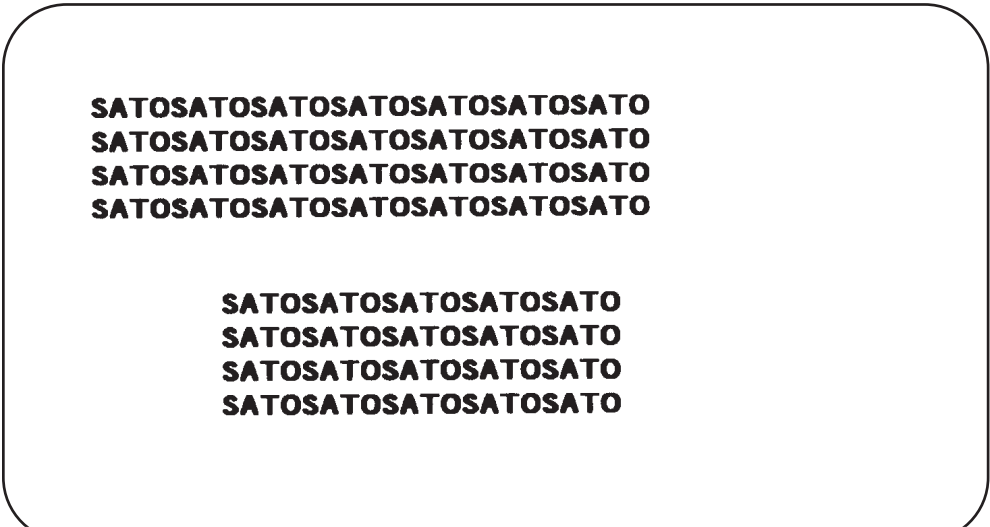

Special Notes

1. Use the Print Position commands (V and H) to locate the new area for the duplicate image (see page 5-55).
2. Position of the new target area must not be inside the original image.
3. If you use the Rotate command, V, H, X and Y axis will be reversed.
4. If the reference area of the target image exceeds the print area, it will not be printed.
5. The allowable ranges for these fields are as follows:

	M-8459S	M-8460S	M-8485S	M-8490S
Horizontal aaaa cccc	0001 to 0896	0001 to 1216	0001 to 1024	0001 to 1344
Vertical bbbb dddd	001 to 1424	001 to 1424	001 to 1424	0001 to 2136

Fonts U, S, M, OA, OB, XU, XS & XM

Command Structure

Font XU: <ESC> XU	Font U: <ESC> U
Font XS: <ESC> XS	Font S: <ESC> S
Font XM: <ESC> XM	Font M: <ESC> M
Font OA: <ESC> OA	Font OB: <ESC> OB

Example: See above

Placement: Preceding the data to be printed

Default: None

Command Function To print text images on a label. These are eight of the built-in fonts available on the printer. All matrices include descenders.

	NON-PROPORTIONAL		PROPORTIONAL ⁽¹⁾
U	5W x 9H dot matrix	XU	5W x 9H dot matrix
S	8W x 15H dot matrix	XS	17W x 17H dot matrix
M	13W x 20H dot matrix	XM	24W x 24H dot matrix
OA	OCR-A font (see note 7 for matrix)		
OB	OCR-B font (see note 7 for matrix)		

(1) These fonts will be printed with proportional spacing only if preceded by an <ESC>PS command.

Input to Printer

```
<ESC>A<ESC>PS
<ESC>H0001<ESC>V0100<ESC>L0202<ESC>XUSATO
<ESC>H0001<ESC>V0175<ESC>L0202<ESC>XSSATO
<ESC>H0001<ESC>V0250<ESC>L0202<ESC>XMSATO
<ESC>H0001<ESC>V0325<ESC>L0101<ESC>OASATO
<ESC>H0001<ESC>V0400<ESC>L0101<ESC>OBSATO
<ESC>H0300<ESC>V0100<ESC>L0202<ESC>USATO
<ESC>H0300<ESC>V0175<ESC>L0202<ESC>SSATO
<ESC>H0300<ESC>V0250<ESC>L0202<ESC>MSATO
<ESC>Q1<ESC>Z
```

Printer Output



Special Notes

1. Characters may be enlarged through the use of the Character Expansion command (see Page 5-23).
2. Character spacing may be altered through the use of the Character Pitch command (see Page 5-26). The default is 2 dots between characters. It is recommended to use a spacing of 5 dots for OCR-A and 1 dot for OCR-B.
3. You may also create custom characters or fonts. See the <ESC>T Custom-Designed Characters command (Page 5-21).
4. A font must be defined for each field to be printed. There is no default font.
5. Fonts U, S, M, OA and OB are identical to fonts U, S, M, OA and OB on the SATO M-8400S printer. (Note: These fonts, except the OA and OB fonts which are fixed in size, will be 33% smaller on an M-8490S)
6. The proportionally spaced fonts XU, XS, XM, XL and XA can be printed with fixed spacing using the <ESC>PS Proportional Space command.
7. The matrices for the OA and OB fonts are scaled so that they will remain a constant size according to the OCR-A and OCR-B specifications when printed on different resolution printers.

	M-8459S/M-8460S/M-8485S	M-8490S
OA Font	15 dots W x 22 dots H	22 dots W x 33 dots H
OB Font	20 dots W x 24 dots H	30 dots W x 36 dots H

Font, Vector

Command Structure Specify Vector Font: <ESC>**\$a,b,c,d**

 Data for Vector Font: <ESC>**\$(data)**

a = A Helvetica Bold (proportional spacing)
 B Helvetica Bold (fixed spacing)

b = Font width (50-999)

c = Font height (50-999 dots)

d = Font variation (0-9) as follows:

- 0 Standard
- 1 Standard open (outlined)
- 2 Gray (mesh) pattern 1
- 3 Gray (mesh) pattern 2
- 4 Gray (mesh) pattern 3
- 5 Standard open, shadow 1
- 6 Standard open, shadow 2
- 7 Standard mirror image
- 8 Italic
- 9 Italic open, shadow

Example: <ESC>**\$A,100,200,0<ESC>\$(123456)**

Placement: Immediately preceding data to be printed.

Default: None

Command Function To specify printing of the unique SATO vector font. The vector font allows large characters to be printed with smooth, round edges. Each character is made of a number of vectors (or lines), and will require slightly more printer compiling time.

Input to Printer <ESC>A
<ESC>H0100<ESC>V0100<ESC>**\$A,100,100,0<ESC>\$(SATO AMERICA**
<ESC>H0100<ESC>V0200<ESC>**\$(VECTOR FONT**
<ESC>H0100<ESC>V0350<ESC>**\$A,200,300,8<ESC>\$(SATO**
<ESC>Q1<ESC>Z

Printer Output



**SATO AMERICA
VECTOR FONT**

SATO

Special Notes

1. The Pitch command can be used with Vector fonts.
2. If the font size designation is out of the specified range, a default value of 50 is used.
4. The font width and height values include ascenders, descenders and other space.
5. A font must be defined for each field to be printed. There is no default font.

Fonts WB, WL, XB & XL

Command Structure

Font WB: <ESC>**WB**a Font XB: <ESC>**XB**a
 Font WL: <ESC>**WL**a Font XL: <ESC>**XL**a

a = 0 Disables auto-smoothing of font
 1 Enables auto-smoothing of font (see notes below)

Example: <ESC>**WB1123456**

Placement: Preceding the data to be printed

Default: None

Command Function To print text images on a label. These are the four auto-smoothing fonts available on the printer.

NON-PROPORTIONAL	PROPORTIONAL⁽¹⁾
WB 18W x 30H dot matrix	XB 48W x 48H dot matrix
WL 28W x 52H dot matrix	XL 48W x 48H dot matrix

(1) These fonts will be printed with proportional spacing only if preceded by an <ESC>PS command.

Input to Printer:

```
<ESC>A<ESC>PS
<ESC>H0001<ESC>V0100<ESC>WB0SATO
<ESC>H0001<ESC>V0185<ESC>WB1SATO
<ESC>H0001<ESC>V0270<ESC>WL0SATO
<ESC>H0001<ESC>V0355<ESC>WL1SATO
<ESC>H0300<ESC>V0100<ESC>XB0SATO
<ESC>H0300<ESC>V0185<ESC>XB1SATO
<ESC>H0300<ESC>V0270<ESC>XL0SATO
<ESC>H0300<ESC>V0355<ESC>XL1SATO
<ESC>Q1<ESC>Z
```

Printer Output:



SATO	SATO
SATO	SATO
SATO	SATO
SATO	SATO

Special Notes

1. Auto-smoothing (when enabled) is only effective if the character expansion rate is at least (3) times in each direction.
2. Characters may be enlarged through the use of the <ESC>L Character Expansion command (see Page 5-23).
3. Character spacing may be altered through the use of the <ESC>A Character Pitch command (see Page 5-26).
4. A font must be defined for each field to be printed. There is no default font.
5. The proportionally spaced fonts XU, XS, XM, XL and XB can be printed with fixed spacing using the <ESC>PS Proportional Space command.

Form Feed

Command Structure	<ESC>A(space)<ESC>Z
	Example: See above
	Placement: Separate data stream sent to printer
	Default: None
Command Function	To feed a blank tag or label, which is the equivalent of a “form feed”
Input to Printer	<ESC>A(space) <ESC>Z
Printer Output	Blank label or tag

Form Overlay, Recall

Command Structure <ESC>/

Example: See above

Placement: Must be preceded by all other data and placed just before the Print Quantity command (<ESC>Q)

Default: None

Command Function To recall the label image from the form overlay memory for printing. This command recalls a stored image from the overlay memory. Additional or different data can be printed with the recalled image.

Input to Printer

```
<ESC>A
<ESC>H01000<ESC>V0125
<ESC>STHIS IS THE STORED IMAGE WITH A BARCODE
<ESC>H0100<ESC>V0165<ESC>B103100*12345*
<ESC>&<ESC>Z
```

```
<ESC>A<ESC>H0100<ESC>V0050
<ESC>STHIS IS RECALLING AND ADDING TO THE STORED IMAGE<ESC>/
<ESC>Q1<ESC>Z
```

Printer Output

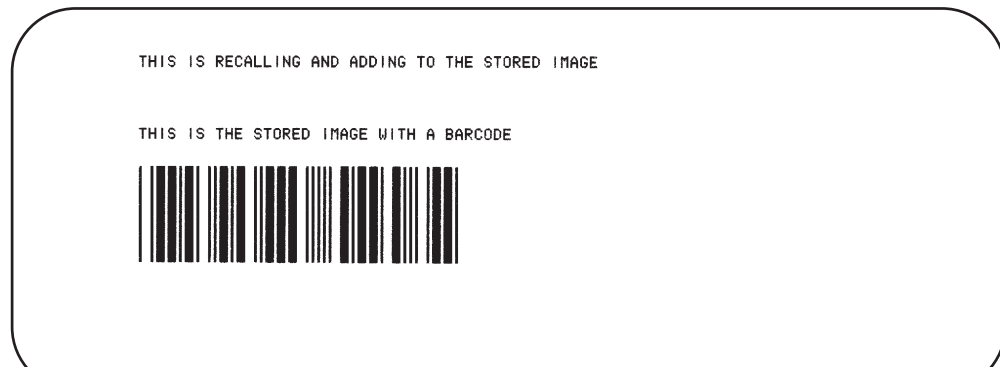

Special Notes

1. The overlay is stored using the <ESC>& Form Overlay Store command (see Page 5-41).
2. If the this command is used with the <ESC>AX Expanded Print Length command (see page 5-53) the Form Overlay length cannot exceed 14".

Form Overlay, Store

Command Structure	<ESC>& Example: See above Placement: Must be preceded by all other data and placed just before the Stop command (<ESC>Z) Default: None
Command Function	To store a label image in the volatile form overlay memory. Only one label image may be stored in this memory area at a time.
Input to Printer	<ESC>A <ESC>H0100<ESC>V0125 <ESC>STHIS IS THE STORED IMAGE WITH A BARCODE <ESC>H0100<ESC>V0165<ESC>B103100*12345* <ESC>& <ESC>Z
Printer Output	There is no output from this command. It stores the label image in the overlay buffer.
Special Notes	<ol style="list-style-type: none">1. Remember that this storage is volatile. Therefore, if the printer loses power, the overlay must be sent again.2. The overlay is recalled using the <ESC>/ Form Overlay Recall command (see Page 5-40).3. Form overlays do not have to be recompiled each time they are called to be printed and therefore may result in much faster print output.

Graphics, Custom

Command Structure <ESC>Gabbccc(data)

a = Specifies format of data stream to follow
 B Binary format
 H Hexadecimal format

bbb = Number of horizontal 8 x 8 blocks
 (see note 7 for allowable range)

ccc = Number of vertical 8 x 8 blocks
 (see note 7 for allowable range)

(data)= Hex data to describe the graphic image

Example: <ESC>GH006006
 See Appendix C for a detailed example

Placement: May be placed anywhere within the data stream after the necessary position commands.

Default: None

Command Function To create and print custom graphics (logos, pictures, etc.) on a label. The graphic image may be printed along with other printed data to enhance label appearance or eliminate the need for preprinted label stock. Using a dot-addressable matrix, design the graphic image in 8 dot by 8 dot blocks, then send it in a binary format to the printer.

Printer Input

```
<ESC>A
<ESC>H0100<ESC>V0100<ESC>GH006006
FFFFFFFFFFFFFFFFFFFFFFFFC00000000003
C00000000003C000FFFFFFFF3C00080000013
C00080000013C0009FFFFFF13C00080000013
C00080000013C0009FFFFFF13C00080000013
C00080000013C000FFFFFFFF3C000000000003
C00000000003C00000000003C00000000003
C00000000003C00000000003C00003C00003
C00007E00003C0000FF00003C0000FF00003
C0000FF00003C0000FF00003C00007E00003
C00003C00003C00003C00003C00003C00003
C00003C00003C00003C00003C00003C00003
C00003C00003C00003C00003C00003C00003
C00003C00003C00001800003C00000000003
C00000000003FFFFFFFFFFFFFFFFFFFFFFFF
<ESC>H0300<ESC>V0100<ESC>XSPLEASE PLACE YOUR DISK
<ESC>H0300<ESC>V0150<ESC>XSIN A SAFE PLACE
<ESC>Q1<ESC>Z
```

See Appendix C for a details on the data format.

Printer Output



Special Notes

1. Do not use ASCII <CR> or <LF> characters (carriage return or line feed) as line delimiters within the graphic data or the actual image will not be printed as specified.
2. A custom graphic cannot be enlarged by the <ESC>L Character Expansion command (Page 5-23).
3. A custom graphic is not affected by either of the Rotation commands. Therefore, always design and locate your graphic image to print in the appropriate orientation.
4. Use an optional Memory Card to expand the print length.
5. To store graphic images in an optional memory card, see the Memory Card Functions section.
6. The binary format reduces the transmission time by 50%.
7. The maximum allowable settings are:

	M-8459S	M-8460S	M-8485S	M-8490S
Hor Blocks bbb	001 to 112	001 to 152	001 to 128	001 to 168
Vertical Blocks ccc				
Std 7"	001 to 178	001 to 178	001 to 178	001 to 267
Exp 14"	001 to 356	001 to 356	001 to 356	001 to 534

Graphics, PCX

Command Structure <ESC>**GP**aaaa,(data)

aaaa = Number of bytes to be downloaded

Example: <ESC>**GP32000**, ... data...

Placement: Anywhere within the job data stream

Default: None

Command Function To allow the creation and printing of graphic images using a PCX file format.

Printer Input See Appendix Appendix C for a detailed example

```
<ESC>A
<ESC>V0150<ESC>H0100<ESC>GP03800,(...Data...)
<ESC>Q1
<ESC>Z
```

Printer Output



Special Notes

1. The maximum number of bytes that can be downloaded is 32K (compressed). The number specified by this command includes the PCX header information. The maximum size of the uncompressed PCX file is 64K. If the uncompressed file exceeds 64K, the graphic will not print.
2. Only black and white PCX files can be downloaded.
3. The image created by this command cannot be rotated.
4. The file size specified by this command is the DOS file size in bytes.

Job ID Store

Command Structure	<ESC>IDaa aa = Job ID assigned (01 to 99) Example: <ESC>ID09 Placement: Immediately following the <ESC>A in the job data stream. Default: None
Command Function	To add an identification number to a job. The status of the job can then be determined using the ENQ command in the Bi-Com status mode (See Section 5: Interface Specifications for more information).
Printer Input	<ESC>A <ESC>ID02 ... Job ... <ESC>Z
Printer Output	There is no printer output as a result of this command.
Special Notes	<ol style="list-style-type: none">1. Works only in Bi-Com mode. The Job ID number must be stored before Bi-Com status mode can be used.2. If more than one ID number is sent in a single job, i.e. <ESC>A <ESC>ID01 <ESC>ID02 the last number transmitted will be used.

Journal Print

Command Structure <ESC>J

Example: See above

Placement: Immediately following <ESC>A

Default: None

Command Function To print text in a line by line format on a label. By specifying this command, you automatically select Font XS with a Character Expansion of 2x2. You also establish a base reference point of H2,V2. The character pitch is 2 dots and the line gap is 16 dots. Simply issue an ASCII <CR> at the end of each text line.

Input to Printer <ESC>A
 <ESC>J WITH THE JOURNAL FEATURE
 YOU CAN PRINT TEXT WITHOUT
 USING ANY FONT COMMANDS
 OR POSITION COMMANDS
 <ESC>Q1<ESC>Z

Printer Output



WITH THE JOURNAL FEATURE
 YOU CAN PRINT TEXT WITHOUT
 USING ANY FONT COMMANDS
 OR POSITION COMMANDS

Special Notes

1. Journal mode assumes a maximum label width . Otherwise, you may print where there is no label and damage your print head.
2. It is effective only for the current print job.

Lines and Boxes

Command Structure	Line	<ESC> FWaabcccc
	aa	= Width of horizontal line in dots (01-99)
	b	= Line orientation H Horizontal line V Vertical Line
	cccc	= Length of line in dots (see Note 2 for max length)
	Box:	<ESC> FWaabbVccccHdddd
	aa	= Width of horizontal side in dots (01-99)
	bb	= Width of vertical side in dots (01-99)
	cccc	= Length of vertical side in dots (see Note 2 for max length)
	dddd	= Length of horizontal side in dots (see Note 2 for max length)
	Example:	<ESC> FW02H0200
	Placement:	Following the necessary positioning commands
	Default:	None
Command Function	To print horizontal lines, vertical lines, and boxes as images on the label.	
Input to Printer	<ESC>A <ESC>H0100<ESC>V0100<ESC> FW20H0200 <ESC>H0320<ESC>V0100<ESC> FW20V0200 <ESC>H0350<ESC>V0100<ESC> FW1010H0200V0200 <ESC>Q1<ESC>Z	

Printer Output

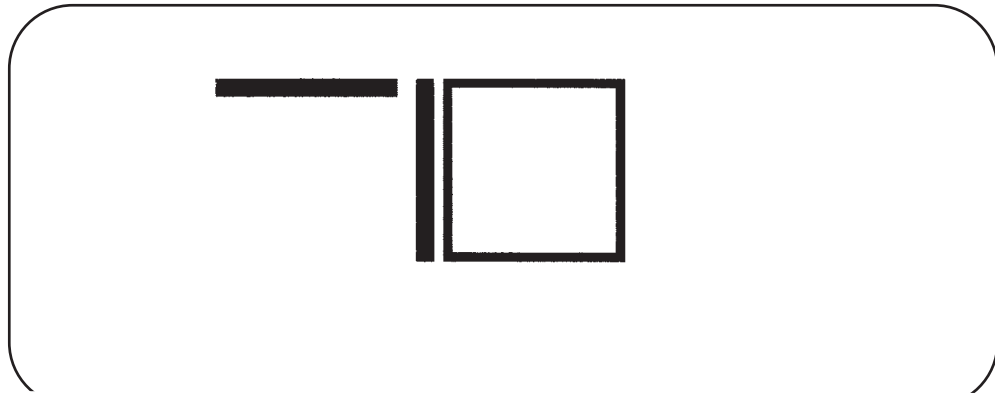

Special Notes

1. It is recommended that all lines and boxes be specified in the normal print direction.
2. The maximum allowable lengths are as follows.

LINE/BOX LENGTH	M-8459S	M-8460S	M-8485S	M-8490S
Horizontal cccc	0001 to 896	0001 to 1216	0001 to 1024	0001 to 1344
Vertical cccc	0001 to 1424 0001 to 2824 with Expanded Print Length	0001 to 1424 0001 to 2824 with Expanded Print Length	0001 to 1424 0001 to 2824 with Expanded Print Length	0001 to 2136 0001 to 4272 with Expanded Print Length

Line Feed

Command Structure

`<ESC>Eaaa`

aaa = Number of dots (001-999) between the bottom of the characters on one line to the top of the characters on the next line

Example: `<ESC>E010`

Placement: Preceding the text that will use the line feed function

Default: None

Command Function

To print multiple lines of the same character size without specifying a new print position for each line. With the Line Feed command, specify the number of dots you want between each line. Then, send an ASCII `<CR>` at the end of each line of text. The printer automatically identifies the size of the last character, moves down the number of dots specified, and begins printing the next line.

Input to Printer

```
<ESC>A
<ESC>E010<ESC>H0050<ESC>V0050<ESC>L0202<ESC>S
THIS IS THE 1ST LINE<>CR>
THIS IS THE 2ND LINE>CR>
THIS IS THE 3RD LINE>CR>
<ESC>Q1<ESC>Z
```

Printer Output



```
THIS IS THE 1ST LINE
THIS IS THE 2ND LINE
THIS IS THE 3RD LINE
```

Special Notes

1. It is effective only for the current data stream.
2. When printing lines or boxes in the same data stream with the Line Feed command, the Lines and Boxes command should be specified last, preceding `<ESC>Q` Quantity command.
3. This command is invalid only if the value specified is zero.
4. Following this command with a `<CR>` character will allow you to print with auto line feed. The print position will be determined from the value specified and the H value set in the printer. If you specify several H values after this command, the print position will be determined by the H value last specified. You must redefine the font to be used after each H command.

Off-Line/Pause

Command Structure	<ESC>@,nn n
	nn...n = Optional message to be displayed on the LCD. Maximum of 32 characters.
	Example: See above
	Placement: Anywhere in the print job between the <ESC>A and <ESC>Z
	Default: None
Command Function	To specify the printer to come to an off-line state. When used within a print job, the printer goes off-line after finishing the print job.
Input to Printer	<ESC>A <ESC>@, Load Blue Labels and place printer On-Line ...Job... <ESC>Z
Printer Output	There is no printer output for this command. The printer is placed in the Off-Line mode as soon as the current print job is finished.
Special Notes	<ol style="list-style-type: none">1. You must press the LINE key on the front panel to return the printer to an On-Line status (see Operator Panel in Section 2 of this manual).2. Remember, when using this command, that the print job specifies <ESC>Q10, all ten labels will print before the printer goes off-line.

Postnet

Command Structure <ESC>BPn...n

n...n = 5 digits (Postnet-32 format)
 6 digits (Postnet-37 format)
 9 digits (Postnet-52 format)
 11 digits (Postnet-62, Delivery Point format)

Example: <ESC>BP123456789

Placement: Immediately preceding the data to be encoded

Default: None

Command Function To print Postnet bar codes

Printer Input

<ESC>A
<ESC>H0100<ESC>V0120<ESC>BP94089
<ESC>H0100<ESC>V0160<ESC>BP123456
<ESC>H0100<ESC>V0200<ESC>BP123456789
<ESC>H0100<ESC>V0240<ESC>BP12345678901
<ESC>Q1<ESC>Z

Printer Output

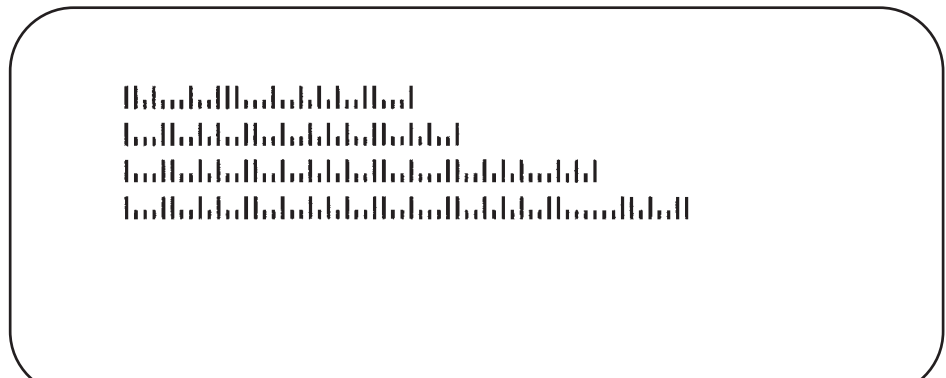

Special Notes

1. If the number of data digits does not match those listed, the command is ignored.
2. Only numeric data will be accepted.

Print Darkness

Command Structure <ESC>#Ea

a = Print darkness value
 (see note 2 for allowable range)

Example: <ESC>#E2

Placement: Must be placed immediately after <ESC>A and
 immediately before <ESC>Z in its own separate data stream

Default: 2

Command Function To specify a new print darkness setting. This command allows software control of the darkness setting for unique media and ribbon combinations.

Input to Printer <ESC>A
 <ESC>#E2
 <ESC>Z

Printer Output There is no printer output for this command.

- Special Notes**
1. This becomes the new setting in the printer configuration for all subsequent print jobs, unless changed. The setting is stored in non-volatile memory and is not affected by cycling power.
 2. The allowable ranges for heat settings are:

Heat Range	M-8459S	M-8460S	M-8485S	M-8490S
a	1	1	1	1
	2	2	2	2
	3	3	3	3
	4			
	5			

The lightest setting is the smallest value and the darkest setting is the largest value.

Print Length, Expanded

Command Structure <ESC>AX Sets the print length to 14" (356 mm)
 <ESC>AR Resets the maximum print length to 7" (178 mm)

Example: See above

Placement: Must follow the Start Code command (see Page 5-70)
 and be in it's own separate data stream.

Default: <ESC>AR

Command Function To double the maximum print length (in feed direction) for a label.

Input to Printer:

```
<ESC>A  
<ESC>AX  
<ESC>Z  
  
<ESC>A  
<ESC>H0050<ESC>V0100<ESC>WB1EXPAND TO:  
<ESC>H0050<ESC>V2700<ESC>WB114 INCHES  
<ESC>Q1<ESC>Z  
  
<ESC>A  
<ESC>AR  
<ESC>Z
```

Printer Output:

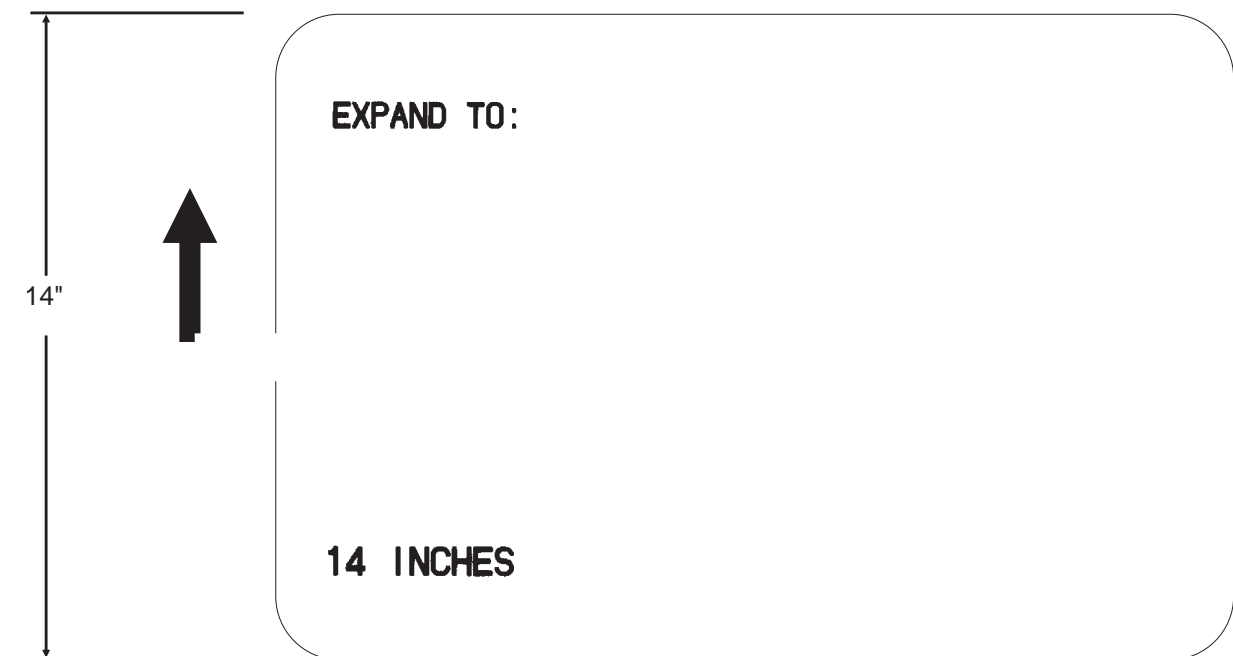

Special Notes

1. AX is effective until AR is sent to reset the printer to its standard print length, or until the printer is repowered.
2. It may be included in an independent data stream to specify the size of the maximum print area:

LENGTH	M-8459S	M-8460S	M-8485S	M-8490S
<ESC>A	14"	14"	14"	14"
<ESC>AX	356 mm	356 mm	356 mm	356 mm
<ESC>Z	2848 dots	2848 dots	2848 dots	4272 dots
<ESC>A	7"	7"	7"	7"
<ESC>AR	178 mm	178 mm	178 mm	178 mm
<ESC>Z	1424 dots	1424 dots	1424 dots	2136 dots

3. When this command is used with the <ESC>& Store Form Overlay command (see page 5-41) the Form length cannot exceed 14".

Print Position

Command Structure	Horizontal Position:	<ESC>Haaaa
	Vertical Position:	<ESC>Vbbbb
	aaaa =	Number of dots horizontally from the base reference point (1 to maximum) See Note 2.
	bbbb =	Number of dots vertically from the base reference point (1 to maximum) See Note 2.
	Example:	<ESC>H0020<ESC>V0150
	Placement:	Preceding any printed field description of lines/boxes, fonts, bar codes or graphics.
	Default:	<ESC>H0001 <ESC>V0001

Command Function The Horizontal and Vertical commands specify the top left corner of a field or label, using the current base reference point as an origin. They also establish a reference point for subsequent fields until the next horizontal and/or vertical print position command is issued.

Input to Printer

```
<ESC>A  
<ESC>H0025<ESC>V0050<ESC>L0303<ESC>MSATO  
<ESC>H0100<ESC>V0150<ESC>MSATO  
<ESC>Q2<ESC>Z
```

Printer Output



Special Notes

1. The print position of a field is affected by both the Rotate (<ESC>R and <ESC>A3) commands.

2. For print lengths greater than 14 inches an optional Memory Card must be used.

	M-8459S	M-8460S	M-8485S	M-8490S
Maximum Print Width aaaa	896 4.4 in. 112 mm	1216 6.0 in. 152 mm	1024 5.0 in. 127 mm	1344 dots 4.4 in. 112 mm
Standard Print Length bbbb	1424 dots 7.0 in. 178 mm	1424 dots 7.0 in. 178 mm	1424 dots 7.0 in. 178 mm	2136 dots 7.0" 178mm
Expanded with <ESC>AX bbbb	2848 dots 14.0 in. 356 mm	2848 dots 14.0 in. 356 mm	2848 dots 14.0 in. 356 mm	4272 dots 14" 356 mm
Maximum Length with Memory Card ⁽²⁾				
128 Kbyte bbbb	1160 dots 5.7 in. 145 mm	860 dots 4.2 in. 107 mm	1022 dots 5.0 in. 127 mm	778 dots 2.5 in. 6.4 mm
512 Kbyte bbbb	4640 dots 22.8 in. 580 mm	3447 dots 16.9 in. 430 mm	4094 dots 16.5 in. 511 mm	3119 dots 10.1 in. 259 mm
1 Mbyte bbbb	9280 dots 45.7 in. 1160 mm	6896 dots 37.9 in. 962 mm	8190 dots 40.3 in. 1024 mm	6240 dots 20.4 in. 520 mm
2 Mbyte bbbb	9999 dots ⁽¹⁾ 49.2 in. 1249 mm	9999 dots ⁽¹⁾ 49.2 in. 1249 mm	9999 dots ⁽¹⁾ 49.2 in. 1249 mm	9999 dots ⁽¹⁾ 32.7 in. 833 mm

(1) Limited by the number of digits in the command field.

(2) When a Memory Card is used to expand the print length, the card capacity is used instead of the internal memory, not in addition to the internal memory.

3. If any part of an image is placed past the maximum number of dots for standard length and or the capacity of the memory card, that part of the image will be lost.
4. If any part of an image is placed past maximum allowable dots across the label, that part of the image will be lost.
5. If you attempt to print where there is no paper, you may damage the print head.
6. For these commands, the leading zeroes do not have to be entered. The command V1 is equivalent to V0001.

Print Quantity

Command Structure	<ESC>Qaaaaa aaaaaa = Total number of labels to print (1-999999) Example: <ESC>Q500 Placement: Just preceding <ESC>Z, unless <ESC>NUL exists, then preceding that. This command must be present in every print job. Default: None
Command Function	To specify the total number of labels to print for a given print job.
Input to Printer	<ESC>A <ESC>H0100<ESC>V0100<ESC>WB1M-8485S <ESC>Q3 <ESC>Z
Printer Output	Three labels containing the data "M-8485S" will be printed.
Special Notes	<ol style="list-style-type: none">1. To pause during a print job, you must press the LINE key on the Operator Panel.2. To cancel a print job, you must turn off the printer, or you may send the <CAN> code if using the Bi-Com mode. Multi-Buffer jobs can be cleared with the <ESC>* Clear Print Job(s) and Memory command (see page 5-29).3. When used with the <ESC>F Sequential Numbering command (see Page 5-68, the Print Quantity value should be equal to the total number of labels to be printed.4. If you do not specify a Print Quantity, the printer will not print a label.5. For this command, leading zeroes do not have to be entered. The command Q1 is equivalent to Q000001.

Print Speed

Command Structure <ESC>**CSa**

a = Designates the speed selection (see note 2)

Example: <ESC>**CS6**

Placement: Must be placed immediately after <ESC>A and immediately before <ESC>Z in its own separate data stream

Default: As previously set in the printer configuration

Command Function To specify a unique print speed through software for a particular label. This allows flexibility in finding the best performance and quality for the particular label format, media, and ribbon. All subsequent labels will print at this speed unless the speed is changed with this command or through the Operator Panel.

Input to Printer <ESC>A
 <ESC>**CS6**
 <ESC>Z

Printer Output There is no printer output for this command. It sets the print speed of the printer.

- Special Notes**
1. This becomes the new setting in the printer configuration for all subsequent print jobs, unless changed. The setting is stored in non-volatile memory and is not affected by cycling the power.
 2. The allowable speed ranges are:

Print Speed a	M-8459S	M-8460S	M-8485S	M-8490S
2	2 ips 50 mm/sec			
3	3 ips 75 mm/sec			
4	4 ips 100 mm/sec	4 ips 100 mm/sec	4 ips 100 mm/sec	4 ips 100 mm/sec
5	5 ips 125 mm/sec			
6		6 ips 150 mm/sec	6 ips 150 mm/sec	6 ips 150 mm/sec
8		8 ips 200 mm/sec	8 ips 200 mm/sec	8 ips 200 mm/sec
10		10 ips 250 mm/sec	10 ips 250 mm/sec	

Repeat Label

Command Structure	<ESC>C
	Example: See above
	Placement: Must be placed immediately after <ESC>A and immediately before <ESC>Z in its own separate data stream
	Default: None
Command Function	To print duplicate of the last label printed
Input to Printer	<ESC>A <ESC>C <ESC>Z
Printer Output	A duplicate of the previous label will be printed.
Special Notes	1. This command will have no effect if the power to the printer was cycled off and back on since printing the previous label.

Replace Data (Partial Edit)

Command Structure <ESC>**0** (<ESC>zero)

Example: See above

Placement: Must follow <ESC>A and precede all other print data

Default: None

Command Function To replace a specified area of the previous label with new data. This command will cause the previous label to print along with any changes specified within the current data stream.

Input to Printer

```
<ESC>A
<ESC>H0025<ESC>V0020<ESC>WB0Company Name
<ESC>H0025<ESC>V0085<ESC>WB1SATO
<ESC>H0025<ESC>V0150<ESC>WL0SATO
<ESC>H0025<ESC>V0215<ESC>WL1SATO
<ESC>Q1<ESC>Z
```

```
<ESC>A
<ESC>0<ESC>H0025<ESC>V0020<ESC>WB0SATO
<ESC>Q1<ESC>Z
```

Printer Output



Company Name

SATO

SATO
SATO



SATO

SATO

SATO
SATO

Special Notes

1. Specify the exact same parameters for the image to be replaced as were specified in the original data stream, including rotation, expansion, pitch, etc. This will ensure that the new data will exactly replace the old image. If the replacement data contains fewer characters than the old data, then the characters not replaced will still be printed.
2. This command will not function if the power has been cycled off and back on since the last label was printed.
3. Proportional Pitch text cannot be used with this command.

Reverse Image

Command Structure <ESC>(aaaa,bbbb

a = Horizontal length in dots of reverse image area
 b = Vertical height in dots of reverse image area.
 See Note 6 for field ranges

Example: <ESC>(100,50

Placement: This command must be preceded by all other data and be placed just before <ESC>Q

Default: None

Command Function To reverse an image area from black to white and vice versa. Use the Print Position commands (<ESC>H and <ESC>V) to locate the top left corner of the reverse image area.

Input to Printer

```

<ESC>A
<ESC>H0050<ESC>V0120<ESC>L0202<ESC>WB1REVERSE
<ESC>H0250<ESC>V0300<ESC>L0202<ESC>WB1HALF
<ESC>H0040<ESC>V0110<ESC>(370,100
<ESC>H0240<ESC>V0290<ESC>(220,47
<ESC>Q1<ESC>Z
  
```

Printer Output

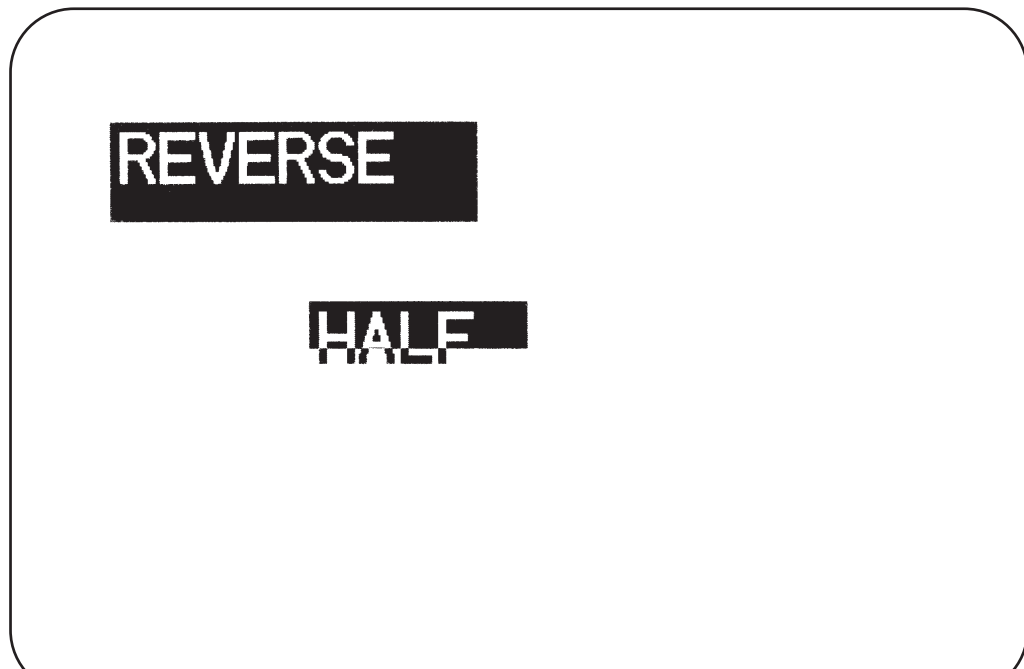

Special Notes

1. A reverse image area is affected by the rotate commands. Therefore, always assume the printer is in the normal print orientation when designing and sending the Reverse Image command.
2. If using reverse images with the form overlay, place this command before the Form Overlay command in the data stream.
3. If the Rotate commands are used with this command, the V and H parameters are reversed.
4. If the height and width to be reversed contain other than alphanumeric data, the area is not printed.
5. If the values specified exceed the maximum ranges, the reverse image is not created.
6. The maximum allowable settings are as follows:

	M-8459S	M-8460S	M-8485S	M-8490S
Horizontal aaaa	001 to 896	0001 to 1216	0001 to 1024	0001 to 1344
Vertical bbbb	0001 to 1424	0001 to 1424	0001 to 1424	0001 to 2136

Rotate, Fixed Base Reference Point

Command Structure <ESC>%a

a = 0 Sets print to normal direction
 1 Sets print to 90°CCW
 2 Sets print to 180° rotated (upside down)
 3 Sets print to 270° CCW

Example: <ESC>%3

Placement: Preceding any printed data to be rotated

Default: <ESC>%0

Command Function To rotate the print direction in 90° increments without changing the location of the base reference point. The diagram below illustrates the use of the <ESC>% Rotate command. Note that the entire print area is shown, but your label will probably not be as large as the entire area.

Input to Printer

```
<ESC>A
<ESC>%0<ESC>L202<ESC>H0200<ESC>V0100<ESC>MNORMAL DIRECTION
<ESC>%1<ESC>H0200<ESC>V0300<ESC>MONE
<ESC>%2<ESC>H0200<ESC>V0400<ESC>MTWO
<ESC>%3<ESC>H0200<ESC>V0500<ESC>MTHREE
<ESC>Q1<ESC>Z
```

Printer Output

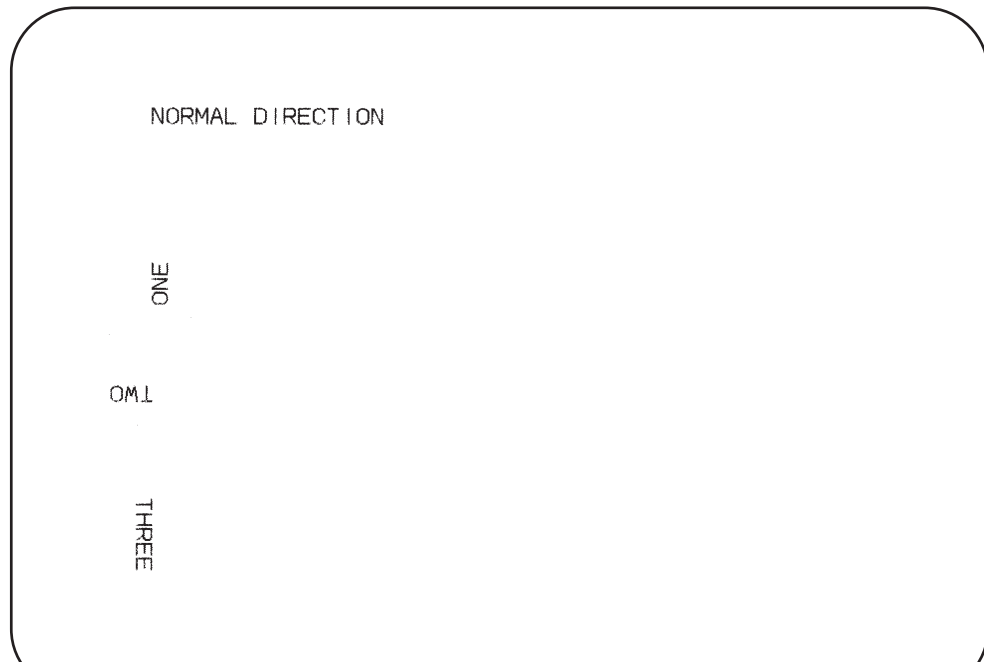

Special Notes

1. Do not combine this command and the <ESC>R Rotate command (see Page 5-66) in the same data stream.
2. The specified values are valid until another Rotate (<ESC>%) command is received.
3. Receipt of a Stop Print (<ESC>Z) command will reset the setting to the default value.

Rotate, Moving Base Reference Point

Command Structure Normal Direction: <ESC>N
 Rotated Direction: <ESC>R

Example: See above

Placement: Preceding any printed data to be rotated

Default: <ESC>N

Command Function The <ESC>R command rotates the printing of all subsequent images in a print job by 90° counterclockwise each time it is used. It also moves the base reference point to a different corner of the print area.

The <ESC>N command returns to the original base reference point and returns printing to the normal orientation.

Input to Printer <ESC>A
 <ESC>N<ESC>L202<ESC>H0100<ESC>V0010<ESC>MNORMAL DIRECTION
 <ESC>R<ESC>H0100<ESC>V0100<ESC>MONE
 <ESC>R<ESC>H0100<ESC>V0100<ESC>MTWO
 <ESC>R<ESC>H0100<ESC>V0100<ESC>MTHREE
 <ESC>R<ESC>H0100<ESC>V0100<ESC>MFOUR
 <ESC>Q1<ESC>Z

Printer Output

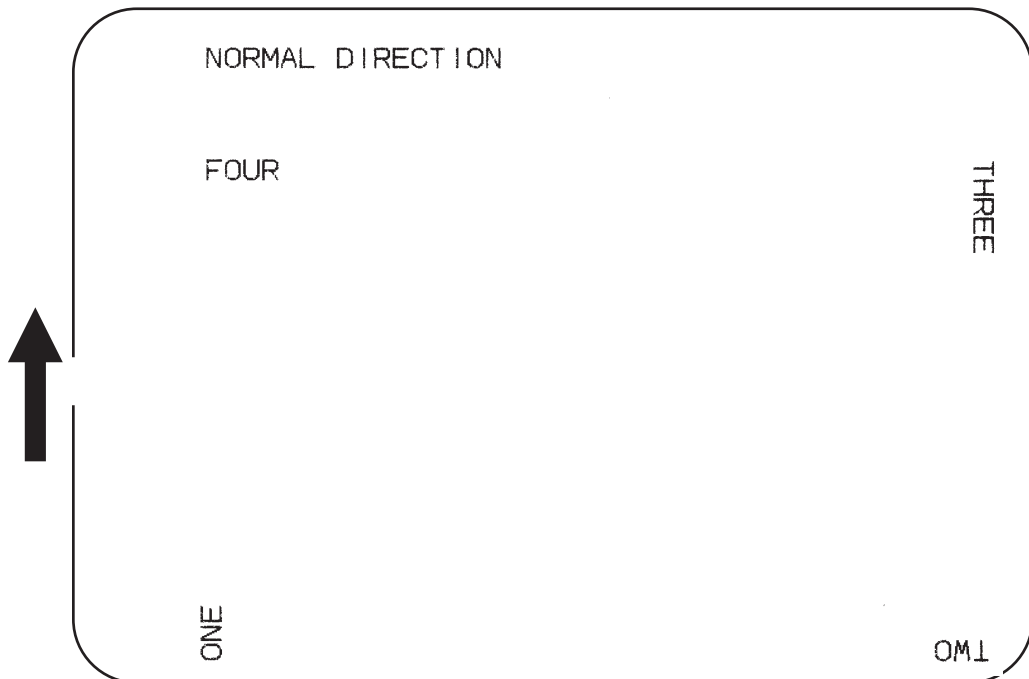

Special Notes

1. Do not combine this command and the <ESC>% rotate command (see Page 5-64) in the same data stream.
2. A custom graphic is not affected by this command. Therefore, always design and locate your graphic image to print in the appropriate orientation.
3. See Section 5, Rotated Fields, Page 5-7, for more information.
4. The specified values are valid until another Rotate (<ESC>R) command is received.
5. Receipt of a Stop Print (<ESC>Z) command will reset the setting to the default value.

Sequential Numbering

Command Structure <ESC>Faaaabcccc,dd,ee

aaaa = Number of times to repeat the same data (0001-9999)

b = Plus or minus symbol (+ for increments; - for decrements)

cccc = Value of step for sequence (0001-9999)

,dd = Number of digits for sequential numbering (01-99). The first incrementing character position starts after the positions exempted from sequential numbering as specified in ee. If these digits are left out, the default is 8.

,ee = Number of digits free from sequential numbering (00-99) starting with the right most position. If these digits are left out, the default is 0.

Example: <ESC>F001-001,04,03

Decrementing

004321321

Free from Decrementing

In this example, the right most (least significant) three digits would not decrement and the next four would decrement.

Placement: Preceding the starting value to be incremented or decremented.

Default: None

Command Function To allow the ability to print sequential fields (text, bar codes) where all incrementing is done within the printer. Up to eight different sequential fields can be specified per label. Sequencing is effective for up to 99-digit numeric data within each field.

Input to Printer

```
<ESC>A<ESC>H0100<ESC>V0100<ESC>MSERIAL NUMBER:
<ESC>H0100<ESC>V0200<ESC>F001+005
<ESC>L0202<ESC>M1000
<ESC>Q2<ESC>Z
```

Printer Output



SERIAL NUMBER:

1000



SERIAL NUMBER:

1005

Special Notes

1. The value specified for Print Quantity (see Page 5-57) should be equal to the number of different sequential values desired multiplied by the number of repeats specified.

Example:

To print 2 sets each of the numbers 1001-1025 on separate labels, we need 50 total labels. The commands would be as follows:

```
<ESC>A  
<ESC>H0100<ESC>V0100<ESC>F002+001<ESC>XM1001  
<ESC>Q50  
<ESC>Z
```

2. It is necessary to specify the print position for each sequential field on a label.
3. Up to eight different sequential fields can be specified per label.
4. This command ignores alpha characters in the sequential number field.
5. This command can not be used with the following commands:
 - Copy Image, Page 5-31
 - Reverse Image, Page 5-62
 - Line Feed, Page 5-49

Start/Stop Label

Command Structure	Start Command: <ESC>A Stop Command: <ESC>Z Example: See above Placement: <ESC>A must precede data <ESC>Z must follow data Default: None
Command Function	For all print jobs, the Start command must precede the data, and the Stop command must follow. The print job will not run properly if these are not in place.
Input to Printer	<ESC>A <ESC>H0001<ESC>V0100<ESC>WB1SATO <ESC>H0130<ESC>V0200<ESC>B103150*M-8485S* <ESC>H0170<ESC>V0360<ESC>L0202<ESC>S*M-8485S* <ESC>Q1<ESC>Z
Printer Output	There is not output for these commands they are not accompanied by other label printing commands. However, these commands must precede and follow each print job sent to the printer.

Calendar Option Commands

The following commands in this section require the Calendar option.

Calendar Increment

Command Structure <ESC>**WP**bbb

a = Y Years
 M Months
 D Days
 h Hours
 bbb = Numeric data: Years (1-9), Months (01-99),
 Days (001-999), Hours (001-999)

Example: <ESC>**WPM03**

Placement: Anywhere within the data stream

Default: None

Command Function To add a value to the printer's current date and/or time, which may then be printed on the label. This command does not change the printer's internal clock setting.

Input to Printer:

```
<ESC>A
<ESC>H0100<ESC>V100<ESC>XB1Current Date:
<ESC>WAMM/DD/YY
<ESC>WPM06
<ESC>H0100<ESC>V0200<ESC>XB1Expiration Date:
<ESC>WAMM/DD/YY
<ESC>Q1<ESC>Z
```

Printer Output:



Current Date: 01/01/95

Expiration Date: 07/01/95

Special Notes:

1. This command requires the Calendar Option. See your SATO representative for more details
2. Once the year increments past "99" it will wrap back to "00".
3. This command can only be used once per data stream.
4. The printer's internal clock may be set through the Calendar Set command (see Page 5-76).
5. If a print quantity of more than one label per job is used, the same time and date will be on each label of the entire print job.

Calendar Print

Command Structure <ESC>**WA**(elements)

(elements) = YY Year
 MM Month
 DD Day
 hh Hour
 mm Minute

Example: <ESC>**WAMM/DD/YY hh:mm**

Placement: Anywhere within the data stream

Default: None

Command Function To specify the printing of a date and/or time field from the printer's internal clock. This may be used to date/time stamp your labels.

Input to Printer:

```
<ESC>A
<ESC>H0100<ESC>V0100<ESC>XB1The current date is:
<ESC>XB1<ESC>WAMM/DD/YY
<ESC>H0100<ESC>V0200<ESC>XB1The current time is:
<ESC>XB1<ESC>WAhh:mm
<ESC>Q1<ESC>Z
```

Printer Output:



The current date is: 01/01/95

The current time is: 00:00

Special Notes:

1. This function requires the Calendar Option. See your SATO representative for details.
2. The date and time elements may be placed in any order for printing.
3. Use a slash (/) to separate date elements and a colon (:) to separate time elements.
4. The font for the date/time elements must be specified before this command.
6. The printer's internal clock may be set through the Calendar Set command (see Page 5-76).
7. This command can be used up to six times per job.
8. The Copy (<ESC>WD) or Reverse Image (<ESC>/) commands cannot be used with this command.
9. Up to 16 characters can be used with this command.

Calendar Set

Command Structure <ESC>**WTaabbccdde**

aa = Year (00-99)
bb = Month (01-12)
cc = Day (01-31)
dd = Hour (00-23)
ee = Minute (00-59)

Example: <ESC>**WT9101311200**

Placement: This command must be sent in an independent data stream.

Default: None

Command Function To set the time and date of the printer's internal clock.

Input to Printer: <ESC>A
 <ESC>**WT9312251300**
 <ESC>Z

Printer Output There is no printer output for this command. It sets the current date to December 25, 1993 and the current time to 1:00 PM in the printer.

Special Notes This command requires the Calendar Option. See your SATO representative for details.

Memory Card Option Commands

These commands require the Memory Card Option.

Note: Before a Memory Card can be used for the first time, it must be initialized using the <ESC>BJF command (see page 5-90). If it is not initialized, the printer will not recognize the card and respond as if no card was installed.

Memory Card Function

Clear Card Memory

Command Structure <ESC>*a,bbb

a = Memory card section to be cleared
 G To clear SATO graphic files from memory card
 P To clear PCX graphic files
 F To clear formats from the memory card
 O To clear TrueType fonts
 bbb = Memory Card storage area to be cleared
 001 to 999 for Graphics, PCX or Formats
 000 to 009 for TrueType fonts

Example: <ESC>*G,01

Placement: This command should be sent to the printer immediately following the <ESC>CC Slot Select command.

Default: None

Command Function To clear individual memory areas in the Memory Card.

Input to Printer <ESC>A
 <ESC>CC1<ESC>*O,09
 <ESC>Z

Printer Output There is no printer output as a result of this command.

Special Notes

1. To clear everything in the memory card, use the <ESC>BJF Memory Card Initialize command (see page 5-90).
2. This command is ignored if there is no data to be cleared.
3. This command is ignored if a memory card is not installed in the printer.

Memory Card Function

Expand Memory Area

Command Structure <ESC>EXa

a = Memory Designation
 0 Use Printer Memory
 1 Use Memory Card Slot 1
 2 Use Memory Card Slot 2

Example: <ESC>EX1

Placement: In its own data stream immediately after powering on.

Default: None

Command Function This command expands the memory available to image labels by using the Memory Card.

Input to Printer <ESC>A
 <ESC>EX2
 <ESC>Z

Printer Output There is no printer output as a result of this command.

Special Notes

1. You must have the optional Memory Card to use this command. Call your local SATO representative for details.
2. When the printer is turned off, the the Memory Card is reset to normal operation.
3. If the Memory Card specified already contains data, it cannot be used for memory expansion.
4. The printer will reserve the specified Memory Card for expanded memory until it is turned off or receives another <ESC>EX Expand Memory Area command.
5. Use care with Line and Box commands as excessively long lines can damage the print head.
6. The maximum vertical position that can be specified by the <ESC>V vertical position command is shown in the table below:

	M-8459S	M-8460S	M-8485S	M-8490S
Standard Print Length	1424 dots 7.0 in. 178 mm	1424 dots 7.0 in. 178 mm	1424 dots 7.0 in. 178 mm	2136 dots 7.0 in. 178 mm
Expanded with <ESC>AX Command	1424 dots 7.0 in. 178 mm	1424 dots 7.0 in. 178 mm	2848 dots 14.0 in. 356 mm	4272 dots 14.0 in. 356 mm
Maximum Length with Memory Card ⁽²⁾				
128 Kbyte	1160 dots 5.7 in. 145 mm	860 dots 4.2 in. 107 mm	1022 dots 5.0 in. 127 mm	778 dots 2.5 in. 6.4 mm
512 Kbyte	4640 dots 72.8 in. 580 mm	3447 dots 16.9 in. 430 mm	4094 dots 16.5 in. 511 mm	3119 dots 10.1 in. 259 mm
1 Mbyte	9280 dots 45.7 in. 1160 mm	6896 dots 37.9 in. 962 mm	8190 dots 40.3 in. 1024 mm	6240 dots 20.4 in. 520 mm
2 Mbyte	9999 dots ⁽¹⁾ 49.2 in. 1249 mm	9999 dots ⁽¹⁾ 49.2 in. 1249 mm	9999 dots ⁽¹⁾ 49.2 in. 1249 mm	9999 dots ⁽¹⁾ 32.7 in. 833 mm

(1) Limited by the number of digits in the command field.

(2) When a Memory Card is used to expand the print length, the card capacity is used instead of the internal memory, not in addition to the internal memory.

7. If a job contains elements out of the memory range, it is ignored.
8. This command cannot be used with the <ESC>AX and <ESC>AR Expanded Print Length commands or the <ESC>R Rotate, Moving Base Reference Point command.
9. If the Forms Overlay command <ESC>& is used with a Memory Card to expand the print area, the Form Overlay length is still limited to 14".

Memory Card Function

Fonts, TrueType Recall

Command Structure <ESC>BJRabbccddeeeff...f

a = Font ID (0 thru 9)
bb = Horizontal Expansion (01 thru 12)
cc = Vertical Expansion (01 thru 12)
dd = Character Pitch (01 thru 99)
eeee = Number of characters to be printed using the font
f f f = Data to be printed

Example: <ESC>BJR1020201000004SATO

Placement: Immediately following the <ESC>CC Slot Select command.

Default: None

Command Function This command recalls previously stored TrueType fonts from a Memory Card.

Printer Input <ESC>A
<ESC>V0100<ESC>H0100<ESC>CC1<ESC>BJR1020201000004SATO
<ESC>Q1<ESC>Z

Printer Output



Special Notes

1. This command requires the Memory Card option. See your SATO representative for details.

Memory Card Function

Fonts, TrueType Store

Command Structure	<p>Begin Download <ESC>BJ(aa...abb..b Download <ESC>BJDccccddddee...e End Download <ESC>BJ)</p> <p>aa..a = 40 byte font description bb..b = 10 byte date information cccc= Memory offset (hexadecimal) dddd = Number of data bytes to be stored (0001-2000) ee...e= Font data to be downloaded</p> <p>Example: <ESC>BJ{50 byte header} <ESC>BJD{5 byte hex memory offset}{data} <ESC>BJ)</p> <p>Placement: Immediately following the <ESC>CC Slot Select command.</p> <p>Default: None</p>
Command Function	This command allows TrueType fonts to be stored in a Memory Card.
Printer Input	The download data stream is very complex and it is recommended that the TrueType Download utility program be used instead of manually creating the required command and data stream.
Printer Output	There is no printer output as a result of this command. See <ESC> BJR TrueType Font Recall command.
Special Notes	<ol style="list-style-type: none"> 1. This command requires the Memory Card option. See your SATO representative for details. 2. The SATO TrueType Download utility program can be used to automate the download process from a computer running Windows 3.1 or above. A copy of this utility program is included as a part of the Memory Card Option.

Memory Card Function Format/Field Recall

Command Structure <ESC>YR,aa <ESC>/D,bb,cc...c

aa = Format number to be recalled (01-99)

bb = Field number to be recalled (01-99)

cc...c= Data to be placed in recalled field.

Example: <ESC>YR,01<ESC>/D,01,99

Placement: Immediately after <ESC>CC Slot Select command

Default: None

Command Function To recall a field from a stored format and place new data in the field.

Printer Input

<ESC>A

<ESC>CC1

<ESC>YR,02<ESC>/D,01,TWO FIELDS OF<ESC>/D,02,VARIABLE DATA

<ESC>Q1<ESC>Z

Printer Output



**TWO FIELDS OF
VARIABLE DATA**

Special Notes

1. This command requires the Memory Card option. See your SATO representative for details.
2. Only one format can be recalled at a time. However, multiple fields may be recalled from the same format.
3. The number of data characters contained in the “cc...c” field cannot exceed the value designated in the <ESC>/N Field Store command. If it does, the data will be truncated to fit the field length defined in the Field Store Command.

Memory Card Function

Format/Field Store

Command Structure <ESC>YS,aa<ESC>/N,bb,cc{.....}

aa = Format number to be stored (01-99)
 bb = Field number to be stored (01-99)
 cc = Length of field to be stored (01-99)
 {.....} = Command stream describing the field to be stored.

Example: <ESC>YS,01<ESC>/N,01,05

Placement: Immediately after <ESC>CC Slot Select command.

Default: None

Command Function To store a format field description in the memory card.

Printer Input

```
<ESC>A
<ESC>CC1
<ESC>YS,02<ESC>/N,01,13<ESC>V0100<ESC>H0100<ESC>XB1
<ESC>/N,02,13<ESC>V0200<ESC>H0200<ESC>XB1
<ESC>Z
```

Printer Output

There is no printer output as a result of this command. See <ESC>YR Format/Field Recall command.

Special Notes

1. This command requires the Memory Card option. See your SATO representative for details.
2. Each job should be sent individually. If more than one job is sent in a data stream, only the first one will be accepted and the remainder ignored.
3. The following commands cannot be stored in a format:

<pre><ESC>CS Print Speed <ESC>NULL Cut Label <ESC>/D Recall Field <ESC>T Custom Characters <ESC>@ Off Line <ESC>BJ TrueType Fonts <ESC>G Store Custom Graphics <ESC>BT Variable Ratio Bar Codes <ESC>0 Partial Edit</pre>	<pre><ESC>C Repeat Label <ESC>Q Print Quantity <ESC>EX Expanded Label Storage <ESC>& Store Form Overlay <ESC>#E Print Darkness <ESC>ID Store Job ID <ESC>* Clear Memory & Buffer <ESC>PI Store PCX Graphics</pre>
---	---

Memory Card Function

Graphics, Custom Recall

Command Structure <ESC>GRaaa

aaa = Graphics storage number (001-999)

Example: <ESC>**GR111**

Placement: The Recall command is sent in a secondary data stream to print the graphic, and follows any necessary position or size commands.

Default: None

Command Function Use the Recall command any time you want to print a graphic image on a label along with other printed data.

Printer Input

Non Rotated Graphic <ESC>A<ESC>CC1 <ESC>V0100<ESC>H0080<ESC>L0505 <ESC> GR001 <ESC>Q1<ESC>Z	Graphic Rotated 90° <ESC>A<ESC>CC1<ESC>%1 <ESC>V0180<ESC>H0250<ESC>L0505 <ESC> GR001 <ESC>Q1<ESC>Z
Graphic Rotated 180° <ESC>A<ESC>CC1<ESC>%2 <ESC>V0180<ESC>H0500<ESC>L0505 <ESC> GR001 <ESC>Q1<ESC>Z	Graphic Rotated 270° <ESC>A<ESC>CC1<ESC>%3 <ESC>V0100<ESC>H0700<ESC>L0505 <ESC> GR001 <ESC>Q1<ESC>Z

Printer Output

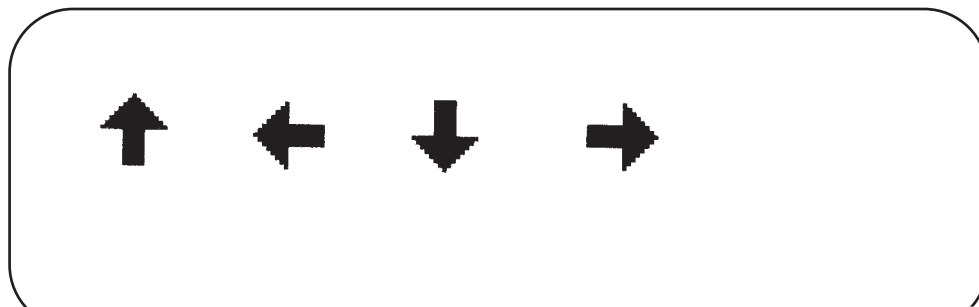

Special Notes

1. The graphic image to be stored cannot be rotated before it is stored. It can be rotated when it is recalled.
2. Graphic images cannot be stored as part of a label format.
3. See the <ESC>GI Custom Graphic Store command.

Example of correct data stream:

```

<ESC>A
<ESC>GIHaaabbb001(DATA)
<ESC>Z
<ESC>A
<ESC>GIHaaabbb002(DATA)
<ESC>Z
  
```

Example of incorrect data stream:

```

<ESC>A
<ESC>GIHaaabbb001(DATA)
<ESC>GIHaaabbb002(DATA)
<ESC>Z
  
```

5. Do not use ASCII <CR> or <LF> characters (carriage return or line feed) as line delimiters within the graphic data or the actual image will not be printed as specified.
6. The graphics storage number (ddd) must be specified with this command.

	M-8459S	M-8460S	M-8485S	M-8490S
Hor Blocks bbb	001 to 112	001 to 152	001 to 128	001 to 168
Vertical Blocks ccc Std 7" Exp 14"	001 to 178 001 to 356	001 to 178 001 to 356	001 to 178 001 to 356	001 to 267 001 to 534

Memory Card Function

Graphics, PCX Recall

Command Structure <ESC>PYaaa

aa = Storage area number (001 thru 099)

Example: <ESC>PY001

Placement: This command must be placed within its own data stream specifying the placement of the graphic.

Default: None

Command Function To recall for printing a graphic file previously stored in a PCX format in the Memory Card.

Printer Input

Normal Rotation
 <ESC>A<ESC>CC1

<ESC>V0100<ESC>H0050<ESC>PY001
 <ESC>Q1<ESC>Z

Rotate Base Reference Point
 <ESC>A<ESC>CC1<ESC>%1

<ESC>V0330<ESC>H0160<ESC>PY001
 <ESC>Q1<ESC>Z

2nd Rotation, Base Reference Point
 <ESC>A<ESC>CC1<ESC>%2

<ESC>V0330<ESC>H0600<ESC>PY001
 <ESC>Q1<ESC>Z

3rd Rotation, Base Reference Point
 <ESC>A<ESC>CC1<ESC>%3

<ESC>V0100<ESC>H0800<ESC>PY001
 <ESC>Q1<ESC>Z

Printer Output



Special Notes:

1. This command requires Memory Card option. See your SATO representative for details.
2. See the <ESC>PI Store PCX Graphics command.

Memory Card Function

Graphics, PCX Store

Command Structure <ESC>PIaaa,bbbb,{data}

aaa = Storage area number (001 thru 999)

bbbb = Size of PCX file in bytes

{data} = Data

Example: <ESC>**PI001,32000**,{data}

Placement: This command must be placed within its own data stream

Default: None

Command Function To store for later printing a PCX graphic file in the Memory Card.

Printer Input BASIC Program to Download a PCX file to Memory Card #1, Location #1

```
OPEN "C:\WIZARD\GRAPHICS\LION.PCX" FOR INPUT AS #2
DA$ = INPUT$(3800,#2)
C$ = CHR$(27)
WIDTH "LPT1:",255
LPRINT C$;"A";C$;"CC1";
LPRINT C$;"PI001,03800,";DA$
LPRINT C$;"Z";
CLOSE #2
```

Printer Output There is no printer output as a result of this command. See <ESC>PY PCX Graphics Recall command.

- Special Notes:**
1. This command requires Memory Card option. See your SATO representative for details.
 2. Graphics cannot be stored as part of a format.
 3. Only black and white PCX files can be stored.
 4. The file size specified by this command is the DOS file size in bytes.

Memory Card Function Initialize

Command Structure	<code><ESC>BJFaaaaaaa</code> aaaaaaa = Eight character alphanumeric user ID Example: <code><ESC>BJFsatocard</code> Placement: Immediately following the <code><ESC>CC</code> Slot Select command. Default: None
Command Function	This clears all of the data from Memory Card in the specified slot and prepares the card to accept data.
Input to Printer	<code><ESC>A</code> <code><ESC>CC2<ESC>BJFsatocard</code> <code><ESC>Z</code>
Printer Output	There is no printer output as a result of this command.
Special Notes	<ol style="list-style-type: none">1. You must have the optional memory card to use this command. Call your local SATO representative for information.2. All Memory Cards must be initialized before they can be used for the first time.3. Care should be exercised when using this command as it destroys any data previously written to the card. It will clear all data from the card and assign the new ID ("satocard" in the above example).

Memory Card Function Slot Select

Command Structure <ESC>**CCa**

a = Memory Card Slot
 1 Slot 1
 2 Slot 2

Example: <ESC>**CC1**

Placement: Immediately following the <ESC>A Start Code.

Default: Last selected Memory Card Slot.

Command Function Selects the card slot to be used for following Memory Card commands.

Printer Input <ESC>A
 <ESC>**CC1**
 {commands}
 <ESC>Z

Printer Output There is no printer output as a result of this command.

Special Notes 1. This command requires the Memory Card option. See your SATO representative for more information.

Memory Card Function Status

Command Structure <ESC>BJS

Example: <ESC>BJS

Placement: After the <ESC>CC Slot Select command.

Default: None

Command Function Causes the printer to print the card status.

Printer Input <ESC>A
 <ESC>CC1<ESC>BJS
 <ESC>Z

Printer Output



MEMORY CARD
Slot [1]

```

Print buffer expansion 1024 Kbyte
ID Number UNIMCARD
  0 bytes for 0 formats
                    are used
  0 bytes for 0 graphic
                    are used
  0 bytes for 0 PCX files
                    are used
  0 bytes for 0 T.T fonts
                    are used

1048320 bytes free
Expandable print length 9999 dots
                        49.2 inches

Battery Check OK
          
```

Special Notes

1. This command requires the Memory Card option. See your SATO representative for more information
2. The following information is provided on the status label:
 - Line 1: Memory size of the card in Kbytes
 - Line 2: The ID number assigned with the <ESC>BJF command
 - Line 3: Number of formats stored and bytes used
 - Line 4: Number of graphics stored and bytes used
 - Line 5: Number of PCX files and bytes used
 - Line 6: Number of TT fonts stored and bytes used
 - Line 7: Remaining free memory
 - Line 8: Max expandable print length using the card
 - Line 9: Battery check results

Custom Protocol Command Codes Download

Command Structure <ESC>LD,a,b,c,d,e,f,g,h,i

- a = Replacement character for STX in ASCII or hex format
- b = Replacement character for ETX in ASCII or hex format
- c = Replacement character for ESC in ASCII or hex format
- d = Replacement character for ENQ in ASCII or hex format
- e = Replacement character for CAN in ASCII or hex format
- f = Replacement character for NULL in ASCII or hex format
- g = Replacement character for OFFLINE in ASCII or hex format
- h = Auto-Online. Printer powers up in the On Line mode.
 0 = Yes
 1 = No
- i = Zero Slash. Places a slash through the "0" character.
 0 = Yes
 1 = No

Example: <ESC>LD,{},%#,&*,~,0,0

Placement: Immediately following the <ESC>A Start command and in an independent data stream.

Default: Standard Protocol command Codes

Command Function Allows the user to defines custom Protocol Command codes.

Printer Input
 <ESC>A
 <ESC>LD,{},%#,&*,~,0,0
 <ESC>Z

Printer Output A Protocol Command code status label will be printed as a result of the a successful download of a custom set of Protocol Command codes.



STX = 7B ETX = 7D ESC = 25
 ENQ = 23 CAN = 26 NULL = 2A
 OFFLINE = 7E
 AUTO ONLINE = YES
 ZERO SLASH = YES

Press the "FEED" key to activate the User Default or power the printer off to ignore them.



Special Notes

1. Commas must be used to separate the parameters. If a parameter is omitted between two commas, the default Non-Standard Protocol Command codes for that parameter will be used. See Appendix E.
2. This command must be sent as an independent data stream immediately following the <ESC>A Start code and immediately preceding the <ESC>Z Stop code. No other commands can be included in the data stream.
3. If more or less than nine commas are included in the command, the entire command sequence will be ignored. The command must contain exactly nine commas.
4. If two characters are specified for a parameter, it will be interpreted as a hex value. For example:

Command Parameter	Resulting Command Code
2B	+
+	+

If a combination of characters are outside the hexadecimal range, the entire command sequence will be ignored.

5. Downloading Auto Online and Zero Slash settings will overwrite the values selected using the LCD panel. If these settings are changed using the LCD panel, they will overwrite any previously downloaded settings.

Two-Dimensional Symbols

The following commands are used to create the two-dimensional symbologies supported by the printers.

Two-Dimensional Bar Codes

Data Matrix, Data Format

Command Structure <ESC>**BX**aaabbccddeeffghh

- aa = Format ID. 01-06 or 11-16. The values 07 and 17 will not be accepted by the printer.
- bb = Error correction level. 00 ,01, or 04-14. The values 02, 03 or values of 15 or greater will be processed as a 00.
- cc = Horizontal cell size. 03 - 12 dots/cell.
- dd = Vertical cell size. 03 - 12 dots/cell.
- eee = Number of cells in one line. Must use 000 to optimize.
- fff = Number of cell lines. Must use 000 to optimize.
- g = Mirror Image
 - 0 = Normal Print
 - 1 = Reverse Print
- hh = Guide Cell Thickness. 01-15. 01 indicates normal type.

Example: <ESC>**BX03080505000000001**

Placement: Immediately preceding data to be encoded

Default: None

Command Function To designate the format for a Data Matrix two-dimensional bar code image on a label.

Printer Input <ESC>A
 <ESC>%0<ESC>V0100<ESC>H0100<ESC>**BX0505101000000001**
 <ESC>DCDATA MATRIX DATA MATRIX
 <ESC>Q1<ESC>Z

Printer Output There is no printer output as a result of this command. See the <ESC>DC Print Data command for printer output.

- Special Notes**
1. If any of the parameters entered are outside the valid range, a symbol will not be printed when the <ESC>DC Print Data command is sent to the printer.
 2. The number of cells per line (eee) and the number of cell lines (fff) should be specified as all zeroes, allowing the printer to automatically calculate the optimum configuration for the symbol.
 3. The Reference Point for the Data Matrix symbol is the upper-left corner. If an <ESC>R Rotate command is used to rotate the symbol, it will rotate in the counter-clockwise direction.

4. The Format ID specified for “aa” is defined by the following table. The printer only supports the Format ID’s defined in the table.

ID NUMBER	CHARACTER SET	ENCODING SCHEME
16 Bit CRC		
01	Numeric, Space	Base 11
02	Upper Case Alpha, Space	Base 27
03	Upper Case Alpha, Space, Comma, Period, Slash, Minus	Base 41
04	Upper Case Alphanumeric, Space	Base 37
05	ASCII 7-bit, Full Keyboard (20 _H -7F _H)	ASCII
06	ISO 8-bit, International (20 _H -FF _H)	8-Bit
32 Bit CRC		
11	Numeric, Space	Base 11
12	Upper Case Alpha, Space	Base 27
13	Upper Case Alpha, Space, Comma, Period, Slash, Minus	Base 41
14	Upper Case Alphanumeric, Space	Base 37
15	ASCII 7-bit, Full Keyboard (20 _H -7F _H)	ASCII
16	ISO 8-bit, International (20 _H -FF _H)	8-Bit

5. The maximum number of data characters that can be specified for either the 16-Bit or 32-Bit CRC modes is 500.

Two-Dimensional Bar Codes

Data Matrix, Print Data

Command Structure <ESC>DCxx...x

xx...x= Data, maximum of 500 characters

Example: <ESC>DC00006000

Placement: Immediately following the <ESC>BC Data Format designation command or the <ESC>FX Sequential Numbering command.

Default: None

Command Function To print a Data Matrix two-dimensional bar code image on a label.

Printer Input

```
<ESC>A
<ESC>%0<ESC>V0100<ESC>H0100<ESC>BX05051010000000001
<ESC>DCDATA MATRIX DATA MATRIX
<ESC>Q1<ESC>Z
```

Printer Output



Special Notes

1. The maximum amount of data that can be printed with this command is 500 characters.
2. If an <ESC>BX Data Format designation command contains any parameters out of the valid range, no symbol will be printed when this command is sent.

Two-Dimensional Bar Codes

Data Matrix, Sequential Numbering

Command Structure <ESC>FXaaabcccddeee

aaa = Number of duplicate labels to be printed (001 -999)
b = Increment or Decrement
 + = Increment
 - = Decrement
ccc = Increment/Decrement Steps (001 - 999)
ddd = Sequential numbering start position (001 - 999)
 Referenced to left side.
eee = Incremented data length measured from start position
 (001 - 999)

Placement: Immediately following the <ESC>BX Data Format
 designation command and preceding the <ESC>DC
 Print Data Command.

Default: None

Command Function To print sequential numbered Data Matrix symbols.

Printer Input

<ESC>A
<ESC>V0100<ESC>H0100
<ESC>BX03081010000000001
<ESC>FX002+001005003<ESC>DC000060000
<ESC>Q4<E SC>Z

Printer Output

Label Set #1



Label Set #2

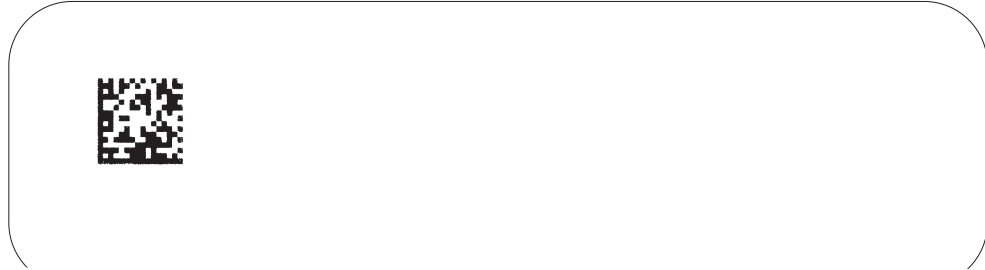

Special Notes

1. The maximum number of <ESC>FX Sequential Numbering commands that can be used in one job is eight.
2. In the example above four total labels will be printed (<ESC>FX002+005003<ESC>DC00006000), the sequential numbering will start at position 5 and the three digits “600” will be incremented in steps of 1. A total of two sets of labels will be printed, the first set of two labels with the value “00006000” and the next two label set with the value “00006010”.

	Label Set #1	Label Set #2
1st Label	00006000	3rd Label 00006010
2nd Label	00006000	4th Label 00006010

3. The <ESC>Q Label Quantity command must be set for the total number of labels to be printed. In the above example, the value for the <ESC>Q command should be 2 sets x 2 labels/set = 4. If, in the above example, it was set to a value of “1”, only the first label would be printed.

Two-Dimensional Bar Codes

Maxicode

Command Structure <ESC>BUaaa,bbb,cccccc,dddd,ee...e

aaa = Service class, numeric only (001-999)
bbb = Country code, numeric only (001-999)
cccccc = ZIP code, alphanumeric (000000-999999)
dddd = Extended ZIP code, numeric only (0001-9999)
ee...e = Low priority message, alphanumeric, 84 digits.

Example: <ESC>BU001,840,94089,0000

Placement: Immediately preceding data to be encoded

Default: None

Command Function To print a Maxicode two-dimensional bar code image on a label. See Appendix B for specific information on using each individual bar code symbol.

Command Function To print a UPS Maxicode symbol.

```
<ESC>A<ESC>V0100<ESC>H0100  
<ESC>BU001,840,94089,0000  
)><Rs>  
01<Gs>96  
1Z12345675  
<Gs>UPSN<Gs>12345E<Gs>089  
<Gs><Gs>1/1<Gs>10.1<Gs>Y  
<Gs><Gs><Gs>UT  
<Rs><Eot>  
!!!!!!!!!!!!!!!!!!!!!!!!!!!!  
<ESC>Q1<ESC>Z
```

Printer Output



Special Notes

1. The Secondary Message field (ee...e) must contain exactly 84 characters. If a smaller message is specified, the field must be padded with “exclamation point” character(s).
2. <Rs> represents Hex 1E, <Gs> represents Hex 1D, <Eot> represents Hex 04, <ESC> represents Hex 1B and <Sp> represents Hex 20.

Two-Dimensional Bar Codes

PDF417

Command Structure <ESC>**BK**aabbcddeefffn...n

- aa = Minimum module dimension (03-09 dots). Will not print if values of 01, 02 or greater than 10 are specified.
- bb = Minimum module pitch dimension (04-24 dots). Will not print if values of 01, 02, 03 or greater than 25 are specified.
- c = Security (error detection) Level (1-8).
- dd = Code words per line (01-30). If 00 is specified for both dd and ee, the printer automatically optimizes the number of rows per symbol.
- ee = Rows per symbol (00 or 03-40). If 00 is specified for both dd and ee, the printer automatically optimizes the number of rows per symbol.
- fff = Number of characters to be encoded (0001-2700).
- nn...n = Data to be printed.

Example: <ESC>BK0304400000021

Placement: Immediately preceding data to be encoded

Default: None

Command Function To print a PDF417 two-dimensional bar code image on a label.

Printer Input

<ESC>A
<ESC>V0100<ESC>H0100<ESC>**BK0607400000021PDF417 PDF417 PDF417**
<ESC>Q1<ESC>Z

Printer Output



Special Notes

1. When the code words per line and the number of rows per symbol ("dd" and "ee") are set to all zeroes, the printer will calculate the optimum configuration.

2. If the product of the values entered for “dd” and “ee” are not equal to or less than the value of “fff” (i.e., “fff” is greater than “dd” x “ee”), an error will occur and the symbol will not be printed. It is recommended that these values each be set to “000” and the printer be allowed to automatically calculate the optimum values.
3. The values for “dd” and “ee” need to be made larger if the security level is increased.
4. The maximum data length is 2700 characters, but may be less depending upon:
 - the minimum module dimension (“aa”)
 - the security level specified by “c”.
 - the number of data characters
5. The Reference Point of the PDF417 symbol is the upper-left corner.
6. The <ESC>F Sequential Numbering command cannot be used with this command.
7. The <ESC>E Line Feed command cannot be used with this command.
8. The Macro and Truncated PDF417 symbols are not supported.
9. The values 00_H thru 1F_H can be specified as print data.
10. This command can be stored in a format.
11. The <ESC>R Rotate command can be used.
12. The print height of the symbol will vary depending upon the data specified; numeric only, alpha only or alphanumeric.

SECTION 6. INTERFACE SPECIFICATIONS

INTRODUCTION

This section presents the interface specifications for the “S” printers. These specifications include detailed information on how to properly interface your printer with your host system.

The following information is presented in this section:

- Interface Types
- Using the Receive Buffer
- RS32C Serial Interface
 - General Specifications
 - Electrical Specifications
 - Pin Assignments
 - Ready/Busy Flow Control
 - X-On/X-Off Flow Control
 - Bi-Directional Communications Protocol
- Centronics Parallel Interface
- Accessory (EXT) Connector

INTERFACE TYPES

In order to provide flexibility in communicating with a variety of host computer systems, the printers come standard with two interface types. The Centronics Parallel interface will probably be the most useful in communicating with IBM PCs and compatibles. The RS232C Serial interface allows connectivity to a number of other hosts. For instructions on how to properly configure your printer for either of these interface types, see the Printer Configuration instructions in Section 2 of this manual.

NOTE: Both the Centronics and RS232C interfaces are active at the same time, i.e. data can be received on either one, however no provision is made for port contention. If data is transmitted to both ports simultaneously, it will cause the data in the receive buffer to be corrupted.

THE RECEIVE BUFFER

The “S” printers have the ability to receive a data stream from the host in one of two ways. The receive buffer may be configured to accept one print job at a time or multiple print jobs. The single job print buffer is generally used by software programs that wish to maintain control of the job print queue so that it can move a high priority job in front of ones of lesser importance. The multiple job buffer, on the other hand, prints all jobs in the order they are received by the printer, and the order of printing cannot be changed.

Single Job Buffer

The printer receives and prints one job at a time. Each job must not exceed 64K bytes. The single Job Buffer mode is selected with DSW2-5 (see page 3-3).

Multi Job Buffer

The printer is able to continuously receive print jobs, compiling and printing other jobs at the same time. It acts much like a “print buffer” to maximize the performance of the host and the printer. The Multi Job Buffer mode is selected with DSW2-5 (see page 3-3).

When using the RS232 Serial interface, the Multi Job Buffer uses either the **Ready/Busy** with **DTR** (pin 20) or **X-On/X-Off** flow control protocols. See these sections for more details. With an empty receiving buffer, the status of **DTR** is “high” (or an **X-On** status if using **X-On/X-Off**), meaning the printer is ready to receive data. When the receive buffer is holding 62K bytes of data (2K bytes from being full), **DTR** will go “low” (or an **X-Off** is sent) indicating the printer can no longer receive data. This condition is called “Buffer Near Full” (see figure below).

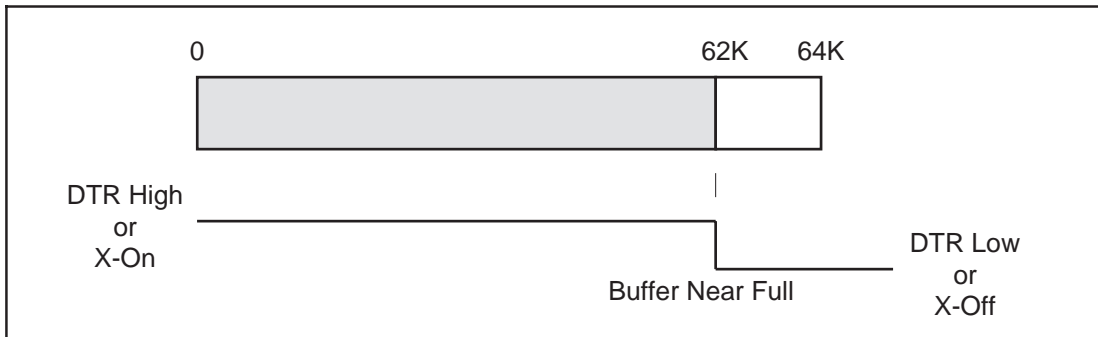

The receiving buffer will not be able to receive more data again until a “Buffer Available” condition occurs. This takes place when the receiving buffer has emptied so that only 56K bytes of data are being held (8K bytes from being full). At this time, **DTR** will go “high” or an **X-On** is sent to tell the host that it can again receive data.

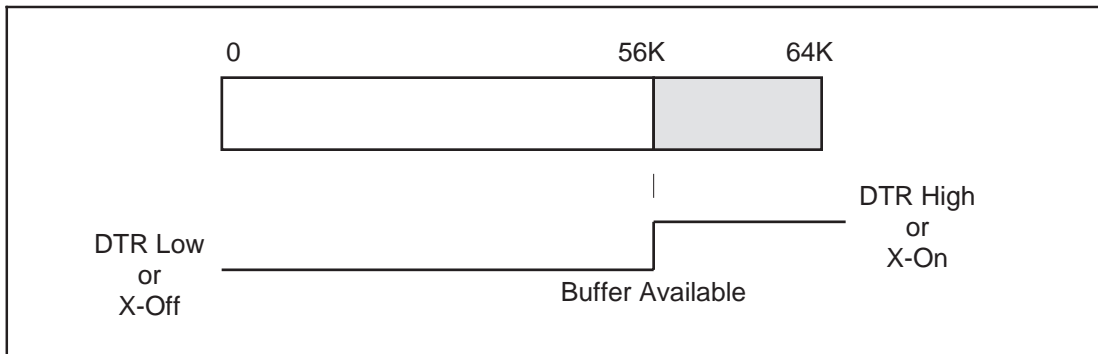

All printer error conditions (i.e., label out, ribbon out) will cause the printer to go busy (**DTR** “low” or **X-Off**) until the problem is corrected and the printer is placed on-line. The printer will also be busy if taken off-line from the front panel.

RS232C SERIAL INTERFACE

GENERAL SPECIFICATIONS

Asynchronous ASCII	Half-duplex communication Ready/Busy Hardware Flow Control Pin 20, DTR Control Pin 4, RTS Error Condition X-On/X-Off Software Flow Control Bi-Directional Communication (ENQ/Response)
Data Transmission Rate	2400, 4800, 9600 and 19200 bps
Character Format	1 Start Bit (fixed) 7 or 8 data bits (selectable) Odd, Even or No Parity (selectable) 1 or 2 Stop bits (selectable)

ELECTRICAL SPECIFICATIONS

Connector	DB-25S (Female)
Cable	DB-25P (Male), 50 ft maximum length. For cable configuration, refer to Cable Requirements appropriate to the RS232C protocol chosen.
Signal Levels	High = +5V to +12V Low = -5V to -12V

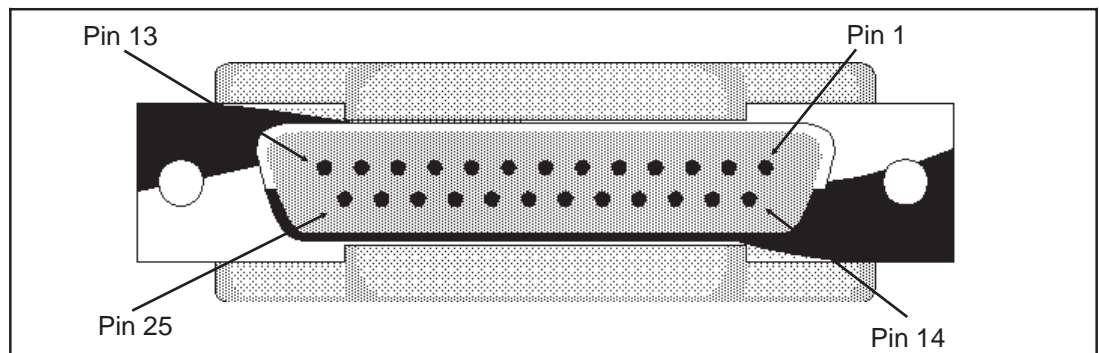

PIN ASSIGNMENTS





RS232C Interface Signals

PIN	DIRECTION	SIGNAL DEFINITION
1	Reference	FG (Frame Ground)
2	To Host	TD (Transmit Data) - Data from the printer to the host computer. Sends X-On/X-Off characters or status data (Bi-Directional protocol).
3	To Printer	RD (Receive Data) - Data to the printer from the host computer.
4	To Host	RTS (Request to Send) - Used with Ready/Busy flow control to indicate an error condition. RTS is high and remains high unless the print head is open (in this case, RTS would return to the high state after the print head is closed and the printer is placed back on-line) or an error condition occurs during printing (e.g., ribbon out, label out).
5	To Printer	CTS (Clear to Send) - When this line is high, the printer assumes that data is ready to be transmitted. The printer will not receive data when this line is low. If this line is not being used, it should be tied high (to pin 4).
6	To Printer	DSR (Data Set Ready) - When this line is high, the printer will be ready to receive data. This line must be high before data is transmitted. If this line is not being used, it should be tied high (to pin 20).
7	Reference	SG (Signal Ground)
20	To Host	DTR (Data Terminal Ready) - This signal applies to Ready/Busy flow control. The printer is ready to receive data when this pin is high. It goes low when the printer is off-line, either manually or due to an error condition, and while printing in the Single Job Buffer mode. It will also go low when the data in the buffer reaches the Buffer Near Full level.

READY/BUSY FLOW CONTROL

Ready/Busy is the hardware flow control for the “S” printers. By raising/lowering the voltage level on Pin 20 of the RS232 port, the printer notifies the host when it is ready to receive data. Pin 4 (**RTS**) and pin 20 (**DTR**) are the important signals on the printer for this method of flow control. The host must be capable of supporting this flow control method for it to function properly.

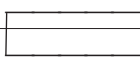
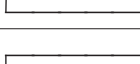
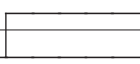
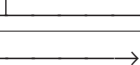
Cable Requirements

HOST	INTERCONNECTION	PRINTER
FG		1 FG (Frame Ground)
TD		3 RD (Receive Data)
		4 RTS (Request to Send)
		5 CTS (Clear to Send)
		6 DSR (Data Set Ready)
*		20 DTR (Data Terminal Ready)
SG		7 SG (Signal Ground)

* This connection at the host side of the interface would depend upon the pin that is being used as the Ready/Busy

Data Streams

Once the flow control method has been chosen for the RS232C interface, the data stream must be sent in a specific manner. The **STX** and **ETX** control characters must frame the data stream.

<STX><ESC>A . . Job#1 . . <ESC>Z<ETX><STX><ESC>A . . Job#n . . <ESC>Z<ETX>

NOTE: All characters, including STX, ESC and ETX are in ASCII.

X-On/X-Off FLOW CONTROL

X-On/X-Off flow control must be used whenever hardware (Ready/Busy) flow control is not available or desirable. Instead of a voltage going high/low at pin 20, control characters representing “Printer Ready” (**X-On** = 11 hexadecimal) or “Printer Busy” (**X-Off** = 13 hexadecimal) are transmitted by the printer on pin 2 (Transmit Data) to the host. The **X-On/X-Off** flow control protocol is selected with DSW1-6 and DSW1-7 (see page 3-2). In order for this method of flow control to function correctly, the host must be capable of supporting it. **X-On/X-Off** operates in a manner similar to the function of pin 20 (**DTR**) as previously explained. When the printer is first powered on and goes on-line, an **X-On** is sent out. In the Single Job Buffer mode, when the printer receives a viable job, it transmits an **X-Off** and begins printing. When it is done printing, it transmits an **X-On**. In the Multi Job Buffer mode, the printer sends an **X-Off** when the “Buffer Near Full” level is reached and a **X-On** when the data level of the buffer drops below the “Buffer Available” mark. When the printer is taken off-line manually, it transmits an **X-Off** indicating it cannot accept data. When it is placed back on line manually, it sends an **X-On**, indicating it is again available for receipt of data. If an error occurs during printing (paper out, ribbon out), the printer sends nothing in the Single Job Buffer mode since the last character transmitted was an **X-Off**. When the error is cleared and the printer resumes printing, no **X-On** is sent until the current job is completed and the printer is once again ready to receive the next job. If it is in the Multi Job Buffer mode, it sends an **X-Off** as soon as an error condition is detected. When the error is cleared and the printer is placed back on-line, it transmits an **X-On** indicating it is again ready to accept data.

Upon power up if no error conditions are present, the printer will continually send **X-On** characters at five millisecond intervals until it receives a transmission from the host.

Cable Requirements

HOST	INTERCONNECTION	PRINTER
FG	←————→	1 FG (Frame Ground)
RD	←————	2 TD (Transmit Data)
TD	————→	3 RD (Receive Data)
	┌————┐	4 RTS (Request to Send)
	└————┘	5 CTS (Clear to Send)
	┌————┐	6 DSR (Data Set Ready)
	└————┘	20 DTR (Data Terminal Ready)
SG	←————→	7 SG (Signal Ground)

Data Streams

The data streams for **X-On/X-Off** are constructed in the same way as they are for Ready/Busy flow control. The **STX** and **ETX** control characters must frame the data stream (NOTE: All characters, including **STX**, **ESC** and **ETX** are in ASCII).

<STX><ESC>A . . Job#1 . . <ESC>Z<ESC>A . . Job#n . . <ESC>Z<ETX>

Example: <STX><ESC>A . . Job#1 . . <ESC>Z<ETX>XXXXX

BI-DIRECTIONAL COMMUNICATIONS

This is a two-way communications protocol between the host computer and the printer, thus enabling the host to check printer status. The **Bi-Directional** flow control protocol is selected with DSW1-6 and DSW1-7 (see page 3-2). When this protocol is selected, there is no busy signal from the printer (pin 20, **DTR**, is always high). The host must request the complete status from the printer, including ready/busy. Whenever the host requests printer status, it transmits an **ENQ** to the printer and the printer will respond with its status within five milliseconds. If printing, it will respond upon finishing the current label, then resume printing. In order for this protocol to work properly, pin 6 (**DTR**) and pin 5 (**CTS**) must be held high by the host. One way to ensure these pins are always in the correct state is to make no connection to them in the interface cable, or preferably, tie pin 20 (**DTR**) to pin 6 (**DSR**) and pin 4 (**RTS**) to pin 5 (**CTS**) at the printer end of the cable.

Cable Requirements

HOST	INTERCONNECTION	PRINTER
FG	←————→	1 FG (Frame Ground)
RD	←————	2 TD (Transmit Data)
TD	————→	3 RD (Receive Data)
SG	←————→	7 SG (Signal Ground)

If a **CAN** (18 hexadecimal) is received by the printer, it will cancel the current print job and clear all data from the receive buffer.

Status Response

The Bi-Com protocol is an advanced version of bi-directional communications where the printer can also report the number of labels remaining to be printed for the current print job. Upon receipt of an **ENQ** command, the printer responds with nine bytes of status information bounded by an **STX/ETX** pair. The Bi-Com protocol works only in the Multi Job Buffer mode. The status information is defined as follows:

<STX>{ 2 Byte ID}{1 Status Byte}{6 Byte Label Remaining}<ETX>

ID - This is a two byte number identifying the current print job ID. The print job ID is defined using the **<ESC>ID** Job ID command transmitted with the print job (see Job ID Store in the command listing for more information on how to use this command). The range is from 00 to 99.

Status - A single byte defining the current status of the printer (see the Status Byte Definition table on page 6-8).

Label Remaining - Six bytes defining the number of labels remaining in the current print job. The range is from 000000 to 999999 labels.

If an **ENQ** is received after the print job specified in the ID bytes has been completed, or there is no data in the buffer, the printer will respond with two “space” characters (20 hexadecimal) for the ID number and six “zero” characters (30 hexadecimal) in the Remaining Labels bytes.

If a **CAN** (18 hexadecimal) command is received while in the B-Communications mode,, it will stop the print job and clear all data from the receive and print buffers. The printer will return an **ACK** (06 hexadecimal) if there is no printer error condition and a **NAK** (15 hexadecimal) if an error condition exists. A delay of five milliseconds or more is required before any new data can be downloaded. The **CAN** command is effective immediately upon receipt, even if the printer is off-line or in an error condition.

Upon receipt of a valid print job (**<ESC>A . . . <ESC>Z**), and **ACK** (06 hexadecimal) will be returned by the printer if there are no errors and a **NAK** (16 hexadecimal) if a printer error exists.

Status Byte Definition, Bi-Com Protocol

ASCII	HEX	DEFINITION
OFF-LINE		
0	30	No Errors
1	31	Ribbon Near End
2	32	Buffer Near Full
3	33	Ribbon Near End and Buffer Near Full
ON-LINE, WAITING FOR DATA		
A	41	No Errors
B	42	Ribbon Near End (not valid on M-8459S)
C	43	Buffer Near Full
D	44	Ribbon Near End and Buffer Near Full
ON-LINE, PRINTING		
G	47	No Errors
H	48	Ribbon Near End (not valid on M-8459S)
I	49	Buffer Near Full
J	4A	Ribbon Near End and Buffer Near Full (not valid on M-8459S)
ON-LINE, WAITING TO DISPENSE A LABEL		
M	4D	No Errors
N	4E	Ribbon Near End (not valid on M-8459S)
O	4F	Buffer Near Full
P	50	Ribbon Near End and Buffer Near Full (not valid on M-8459S)
ON-LINE, COMPILING PRINT JOB		
S	53	No Errors
T	54	Ribbon Near End (not valid on M-8459S)
U	55	Buffer Near Full
V	56	Ribbon Near End and Buffer Near Full (not valid on M-8459S)
OFF-LINE, ERROR CONDITION		
a	61	Receive Buffer Full
b	62	Head Open
c	63	Paper End
d	64	Ribbon End (not valid on M-8459S)
e	65	Media Error
f	66	Sensor Error
g	67	Head Error
h	68	Cover Open
i	69	Memory Card Error
k	6B	Other Error Conditions

CENTRONICS PARALLEL INTERFACE

ELECTRICAL SPECIFICATIONS

Printer Connector	AMP 57-40360 (DDK) or equivalent
Cable Connector	AMP 57-30360 (DDK) or equivalent
Cable Length	10 ft or less
Signal Level	High = +2.4V to +5.0V Low = 0V to -0.4V

DATA STREAMS

Single Job Buffer: The Single Job Buffer mode is not available when using the Centronics interface.

Multi Job Buffer: <ESC>A .. Job#1 .. <ESC>Z<ESC>A .. Job#n .. <ESC>Z

Note that for parallel communications, the **STX** and **ETX** characters are not required .

Centronics Parallel Interface Pin Assignments

PIN	SIGNAL	DIRECTION	PIN	SIGNAL	DIRECTION
1	STROBE	To Printer	19	STROBE Return	Reference
2	DATA 1	To Printer	20	DATA 1 Return	Reference
3	DATA 2	To Printer	21	DATA 2 Return	Reference
4	DATA 3	To Printer	22	DATA 3 Return	Reference
5	DATA 4	To Printer	23	DATA 4 Return	Reference
6	DATA 5	To Printer	24	DATA 5 Return	Reference
7	DATA 6	To Printer	25	DATA 6 Return	Reference
8	DATA 7	To Printer	26	DATA 7 Return	Reference
9	DATA 8	To Printer	27	DATA 8 Return	Reference
10	ACK	To Host	28	ACK Return	Reference
11	BUSY	To Host	29	BUSY Return	Reference
12	PE	To Host	30	PE Return	Reference
13	SELECT	To Host	31		
14			32	FAULT	To Host
15			33		
16			34		
17	FG	Frame Ground	35		
18	+5V (Z=24K ohm)		36		

EXT CONNECTOR

The EXT connector on the rear panel of the “S” printers is intended for use with the external printer accessories such as label rewinders or applicators. The DB-9S type connector provides a choice of four different output signals along with various error conditions.

Pin Assignments

PIN	DIRECTION	SIGNAL DESCRIPTION
1	To Host	Vcc - +5V
2	To Host	Ribbon Near End - This pin goes high when the amount of ribbon on the unwind shaft is approximately 46 feet (14 m). The output will be low when the ribbon is completely out.
3	To Host	Error - This pin goes low when the printer detects an error condition such as head open or receiving buffer full.
4	To Printer	Reprint - The last label will be reprinted when this signal is received.
5	To Printer	Print Start - The printer will print one label when this pin is pulled to ground. This signal must be enabled by placing switch DSW3-5 on the Control Panel in the OFF position.
6	To Host	End Print - It is used to drive an applicator or other external device requiring synchronization with the print cycle. You may choose between four types of output signals using control panel DSW3-6 and DSW3-7 selections.
7	To Host	Label Out - This pin goes low (0V) when a label out error exists.
8	To Host	Ribbon Out - This pin goes low when the ribbon is out.
9	Reference	Signal Ground

NOTE: The signals on pins 2, 3, 6, 7 and 8 each have an open collector output. These pins normally measure +0.7V maximum when a true condition exists. If a false condition occurs, the voltage will drop to 0V. To achieve a signal level of +5V, you must add a 330 ohm, 1/4W pull-up resistor between the open collector output pin and Vcc (pin 1) as illustrated. This will provide a signal level of +5V for a true condition and 0V when a false condition exists. The maximum voltage that can be applied to these pins is +50V and the maximum current they can sink is 500 milliamps.

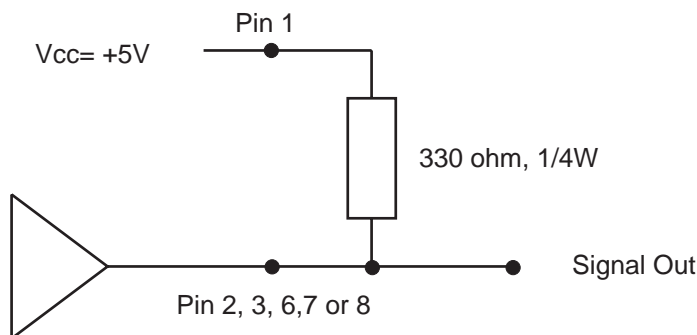

External Connector Input/Output Signal Types

STANDARD OPERATION

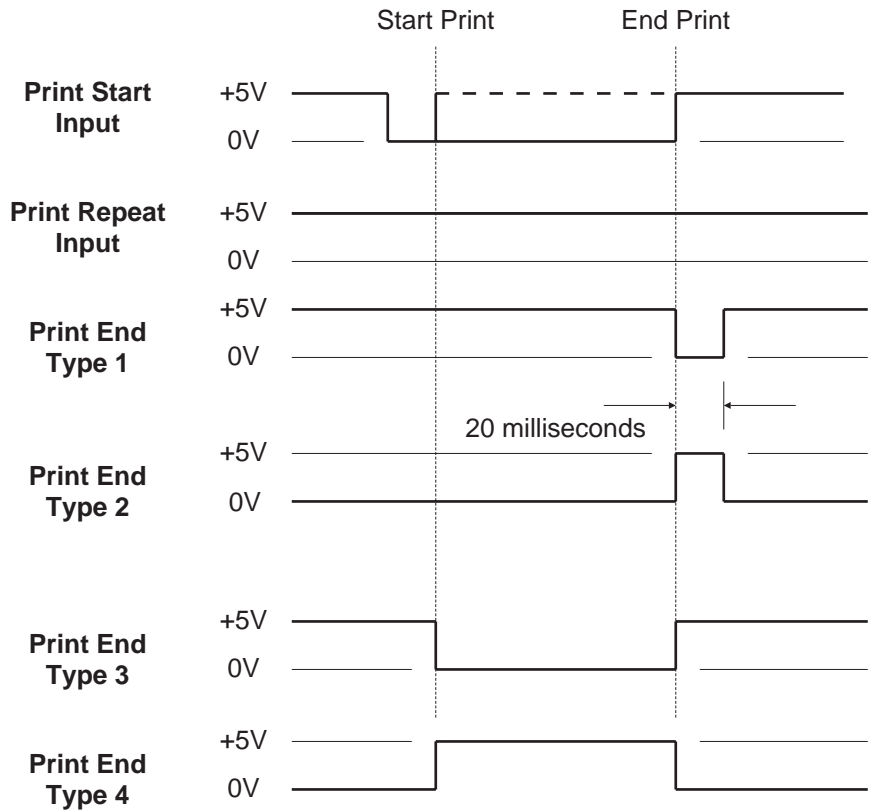

REPEAT PRINT

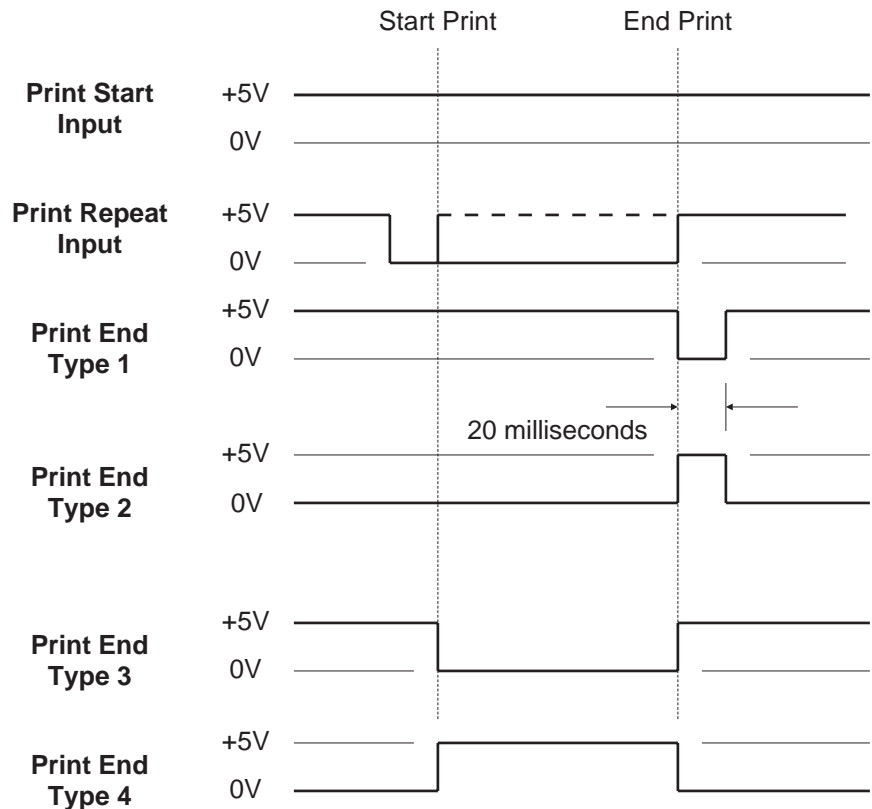

ERROR SIGNALS

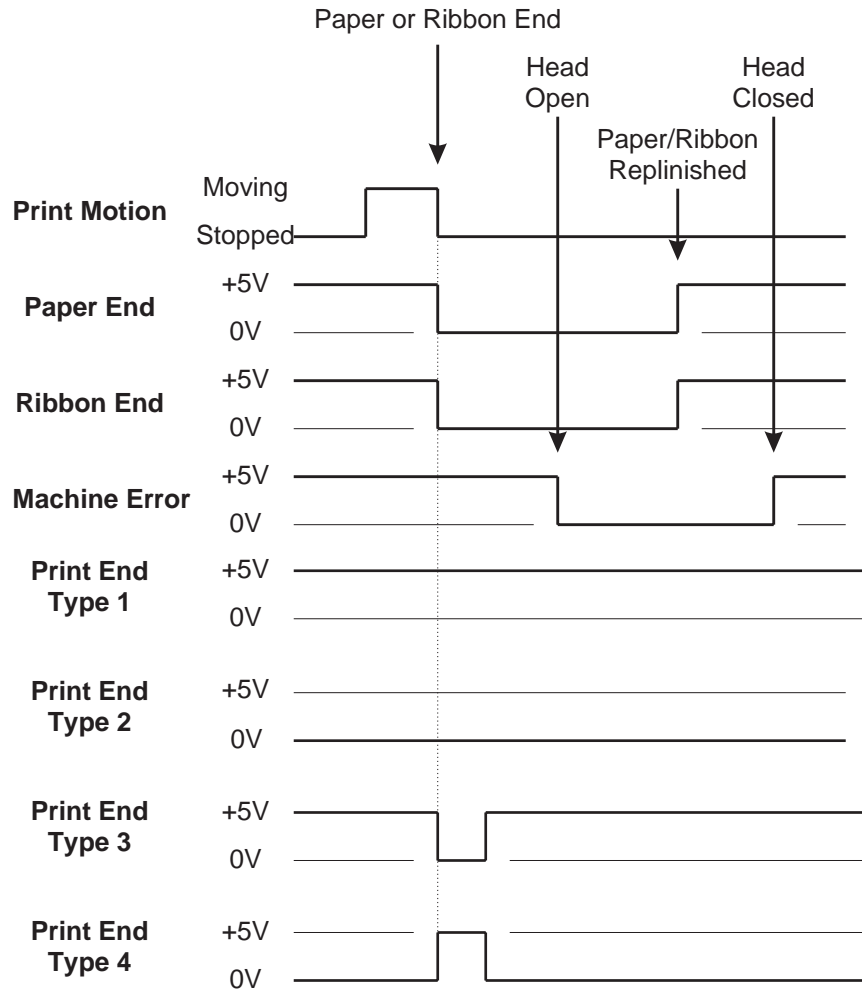

SECTION 7. TROUBLESHOOTING

This section has been devised to help you if you are unable to produce output on the printer. Use this section to make sure the basics have been checked before deciding you are unable to proceed any further. The section is divided into four parts:

- Initial Checklist
- Centronics Parallel Interface
- RS232C Serial Interface
- Error Signals

INITIAL CHECKLIST

1. Is the printer powered up and On-line?
2. Is the ERROR light on the front panel OFF? If this light is ON, it may mean the print head assembly is open.
3. Are the LABEL and RIBBON lights on the front panel OFF? If these lights are ON, labels or ribbons may be loaded incorrectly.
4. Is the Label Hold-Down and Print Head Assembly in the down and latched position?

USING THE CENTRONICS (PARALLEL) INTERFACE

1. Is the IBM parallel printer cable connected securely to your parallel port (DB-25S Female) on the PC and to the Centronics connector on the printer?
2. Is there more than one parallel interface port on your PC (LPT1, LPT2, etc.)? If so, make sure you are sending data out the correct port.
3. When you send the print job to the printer, and it does not respond, do you get an error message on your PC that says "Device Fault" or something similar?

This may mean that the computer doesn't know the printer is there. Verify that:

- A. Both ends of the cable are securely inserted into their respective connectors.
- B. The printer is On-line.
- C. The cable is not defective. There are other things that can cause this error message on your computer, but at this stage, a defective cable may be one of the reasons.

4. When you send the print job to the printer and it does not respond, and there is no error message on the PC:
 - A. Check your data stream for some of the basics. Is your job framed as follows?

`<ESC>A—DATA—<ESC>Z`
 - B. Verify that you've included all required parameters in the data stream.
 - C. Verify the following:
 - You have not typed a "0" (zero) for an "O" (letter) or vice-versa.
 - You have not missed any <ESC> characters where they're needed.
 - Make sure all printer command codes are capital letters.
 - Your protocol codes are set for Standard or Non-Standard and your data stream is consistent with these.
5. If you've checked all of the above and the printer still isn't printing, you may want to try a Hex Dump to determine what (if anything) the printer is receiving from your computer. See the User Test Print section, page 3-16.

The Centronics port is now listening for incoming data. Send your print job. The M-8485S will now print (only once) a Hexadecimal (Hex) Dump of everything it received from the host computer. Each 2-digit hexadecimal character represents a character the printer received. It may be tedious, but now you can analyze and troubleshoot the data stream.

6. While checking the Hex Dump printout, if you notice 0D 0A (Carriage Return and Line Feed) characters throughout. The command string should be continuous and nor CR or LF characters are allowed between the Start Command (<ESC>A) and the Stop Command (<ESC>Z). If you are using BASIC, it may be adding these characters automatically as the line wraps. Adding a "width" statement to your program can help to suppress these extra 0D 0A characters by expanding the line length up to 255 characters. See the beginning of Section 5: Programming for information on writing a program in BASIC.

If you're not programming in BASIC, check to see if you have an equivalent statement in the language you're using to suppress extra carriage returns and line feeds from your data being sent out to the printer. We want the data stream to be one complete line going to the printer.

USING THE RS232C (SERIAL) INTERFACE

1. Is the RS232C Serial cable connected securely to your serial port on the PC (DB-25S Male) and to the RS232C connector on the printer?
2. Is the cable defective? At the very least, you should be using a “Null Modem Cable,” which crosses pins in a specific manner. This should enable your printer to print. But we recommend that you eventually use a cable built to specifications as described in Section 5: Interface Specifications.
3. Check for obvious errors in the data stream. Remember that all print jobs for serial data must be framed by an **STX** and **ETX**. Again, see Section 5 if necessary.
4. If after sending your job to the printer, it only “beeps” indicating a “framing error” message, you may have a configuration problem. There may be some inconsistencies with the Baud Rate, Parity, Data Bits, or Stop Bits in relation to your host computer. If you are confused as to what the printer’s current RS232 settings are, you may choose the SATO defaults (all DIP switches in the OFF position) to achieve 9600 baud, no parity, 8 databits, and 1 stop bit.
5. If you still are unable to get printer output, try the Hex Dump as described in Step 5 under the Centronics Interface troubleshooting. In this case, the printer monitors its RS232C interface for incoming data.
6. From the Hex Dump, if you are seeing extra 0D 0A (CR and LF) characters, and are using BASIC, refer to the beginning of the Command Code section. It provides hints for writing a SATO program in BASIC.

ERROR SIGNALS

LED	LCD MESSAGE	AUDIBLE BEEP	ERROR CONDITION	TO CLEAR
Error On	Machine Error	1 Long	Machine Error	Cycle power on/off
Error On	EEPROM Error	1 Long	EEPROM Read/Write	Cycle power on/off
Error On	Head Error	1 Long	Head	Cycle power on/off
Error On	Sensor Error	3 Short	Sensor	Cycle power on/off
Error Blinks	Card R/W Error	1 Long	Memory Card Read/Write	Cycle power on/off
Error Blinks	Card Low Battery	1 Long	Memory Card Battery Low	Cycle power on/off
Error Blinks	Head Open	3 Short	Head Open	Close head lever
Error Blinks	Cutter Error	3 Short	Cutter	Cycle power on/off
Error On Line Blinks	PARITY ERROR	3 Short	RS232 Parity Error	Cycle power on/off
Error On Line Blinks	Overrun Error	3 Short	RS232 Overrun Error	Cycle power on/off
Error On Line Blinks	Framing Error	3 Short	RS232 Framing Error	Cycle power on/off
Error On Line Blinks	Buffer Over	3 Short	Buffer Overflow	Cycle power on/off
Error Blinks Label On	Paper End	3 Short	Label End	Open/close Head Lever Open/close Label Hold-down
Error Blinks Ribbon On (1)	Ribbon End	3 Short	Ribbon End	Open/close Head Lever Open/close Label Hold-down
Error Blinks Label Blinks	Media Error	3 Short	Media Error	Open/close Head Lever
Ribbon Blinks (1)		None	Ribbon Near End	Replace ribbon with full roll
Line Blinks		None	Buffer Near Full	Slow down transmission rate

(1) The M-8459S does not have a Ribbon LED. This Error Code is not valid.

APPENDIX A. COMMAND CODE QUICK REFERENCE

INSTRUCTION	DESCRIPTION	PAGE
A	Start Code. Begins all print jobs.	Page 5-70
A(space)Z	Form Feed. Feeds a blank tag or label.	Page 5-39
AR	Normal Print Length. This command resets the printer to the Standard print length (7 inches).	Page 5-53
AX	Expanded Print Length. This command sets the printer to the Expanded print length (14 inches).	Page 5-53
A3H-aaaa Vbbbb	Base Reference Point. Establishes a new base reference point position in dots for the current label. Units of measurement are dots. - = Optional character. If included, will shift reference point in negative direction.	Page 5-19

	M-8459S	M-8460S	M-8485S	M-8490S
aaaa = Horizontal Print Offset	+/- 896	+/- 1216	+/- 1024	+/- 1344
bbbb = Vertical Print Offset	0001-1424	0001-1424	0001-1424	0001-2136

Babbcccd	Bar Codes. Prints a 1:3 ratio bar code. a= 0 Codabar 1 Code 39 2 Interleaved 2 of 5 (I 2/5) 3 UPC-A/EAN-13 4 EAN-8 5 Industrial 2 of 5 6 Matrix 2 of 5 7 reserved 8 reserved 9 reserved A MSI B reserved C Code 93 D reserved E UPC-E F Bookland G Code 128 I UCC 128 bb = Number of dots (01-12) for narrow bar and narrow space ccc = Bar height in dots (001-600) d = UCC 128 only 0 No human readable text 1 Human readable at top 2 Human readable at bottom	Page 5-11
----------	--	-----------

INSTRUCTION	DESCRIPTION	PAGE
BDabbcccd	<p>Bar Codes. Prints a 2:5 ratio bar code, except for UPC, EAN, Code 93, Code 128 and UCC128 symbols, which are fixed width bar codes. For values a, bb, ccc and d see instructions for Babbcccd.</p> <p>For UPC/EAN bar codes, this command puts descender bars and humand readable text below the symbol.</p>	Page 5-11
BKaabbccd eeeffnn...n	<p>PDF417. Prints PDF417 2-D symbols.</p> <p>aa = Minimum module dimension (03-09 dots). Will not print for values of 01, 02 or ≥ 10.</p> <p>bb = Minimum module pitch dimension (04-240 dots). Will not print for values of 01, 02, 03 or greater than 25.</p> <p>c = Security level (1-8).</p> <p>dd = Code words per line (01-30). If 00 is specified for dd <i>and</i> ee, printer will automatically optimize settings.</p> <p>ee = Rows/symbol (00 or 03). If 00 is specified for dd <i>and</i> ee, printer will automatically optimize settings.</p> <p>fff = Number of characters to be encoded (0001-2700)</p> <p>nn...n = Data to be printed.</p>	Page 5-103
BPn...n	<p>Postnet. Prints Postnet bar codes.</p> <p>n...n = 5 digit ZIP (Postnet-32 format) 6 digits (Postnet-37 format) 9 digit ZIP+4 (Postnet -52 format) 11 digit ZIP+4+DPC (Postnet-62, Delivery Point format).</p>	Page 5-51
BTabbccddee	<p>Bar Codes. Variable Ratio. provides the ability to print a bar code with a ratio other than those specified through the standard bar code commands (B, BD, and D).</p> <p>a = Bar code option: 0 Codabar 1 Code 39 2 Interleaved 2 of 5 5 Industrial 2 of 5 6 Matrix 2 of 5</p> <p>bb = Narrow space in dots (01-99) cc = Wide space in dots (01-99) dd = Narrow bar in dots (01-99) ee = Wide bar in dots (01-99)</p>	Page 5-17
BUaaa,bbb, cccccc,dddd, ee...e	<p>Maxicode. Prints 2-D Maxicode symbols.</p> <p>aaa = Service class, numeric only (001-999).</p> <p>bbb = Country code, numeric only (001-999).</p> <p>cccccc= ZIP code, alphanumeric (000000-999999).</p> <p>dddd = Extended ZIP code, numeric only (0001-9999)</p> <p>ee...e = Low priority message, alphanumeric, 84 characters.</p>	Page 5-101
BWaabbb	<p>Bar Codes. Expansion. Works together with the BT command to specify an expansion factor and the bar code height for the particular symbol being printed.</p> <p>aa = Expansion factor by which the width of all bars and spaces is increased (01-12)</p> <p>bbb = Bar height by dot (004-600 dots)</p>	Page 5-16

INSTRUCTION	DESCRIPTION	PAGE										
BXaabbccdd eeffffhh	<p>Data Matrix. Data Format. Specifies the format of the Data Matrix 2-D symbology.</p> <ul style="list-style-type: none"> aa = Format ID (01-16, The values 07 and 17 will not be accepted) bb = Error correction level (00, 01, or 04-14, the values 02, 03 or ≥ 15 will not be accepted). cc = Horizontal cell size (03-12 dots/cell) dd = Vertical cell size (03-12 dots per cell) eee = Cells per line. Must use 000 for optimized symbol. fff = Cell lines. Must use 000 to optimize. g = Mirror image <ul style="list-style-type: none"> 0 Normal Print 1 Reverse Print hh = Guide cell thickness (01-15) 01 indicates normal type. 	Page 5-96										
C	<p>Repeat Label. Prints a duplicate of the last label printed.</p>	Page 5-59										
CSa	<p>Print Speed Selection. Specifies a unique print speed in in./sec. through software for a particular label.</p>	Page 5-58										
<table border="1" style="width: 100%; border-collapse: collapse;"> <thead> <tr> <th style="width: 30%;"></th> <th style="width: 15%;">M-8459S</th> <th style="width: 15%;">M-8460S</th> <th style="width: 15%;">M-8485S</th> <th style="width: 15%;">M-8490S</th> </tr> </thead> <tbody> <tr> <td>a = Speed Setting</td> <td>2 = 2 ips 3 = 3 ips 4 = 4 ips 5 = 5 ips</td> <td>4 = 4 ips 6 = 6 ips 8 = 8 ips</td> <td>4 = 4 ips 6 = 6 ips 8 = 8 ips 10 = 10 ips</td> <td>4 = 4 ips 6 = 6 ips 8 = 8 ips</td> </tr> </tbody> </table>				M-8459S	M-8460S	M-8485S	M-8490S	a = Speed Setting	2 = 2 ips 3 = 3 ips 4 = 4 ips 5 = 5 ips	4 = 4 ips 6 = 6 ips 8 = 8 ips	4 = 4 ips 6 = 6 ips 8 = 8 ips 10 = 10 ips	4 = 4 ips 6 = 6 ips 8 = 8 ips
	M-8459S	M-8460S	M-8485S	M-8490S								
a = Speed Setting	2 = 2 ips 3 = 3 ips 4 = 4 ips 5 = 5 ips	4 = 4 ips 6 = 6 ips 8 = 8 ips	4 = 4 ips 6 = 6 ips 8 = 8 ips 10 = 10 ips	4 = 4 ips 6 = 6 ips 8 = 8 ips								
Dabbcccd	<p>Bar Codes. Prints 1:2 ratio bar code. For UPC and EAN bar codes, this will add descender bars. For values a, bb, ccc and d see instructions for Babbcccd.</p>	Page 5-11										
DCxx...x	<p>Data Matrix. Print Data. Prints data using Data Matrix format specified in BX Data Format command.</p> <p>xx...x = Data to be printed. Cannot exceed 500 characters.</p>	Page 5-98										
Eaaa	<p>Line Feed. Provides the ability to print multiple lines of the same character size without specifying a new print position for each line.</p> <p>aaa = Number of dots (1-999) between the bottom of the characters on one line to the top of the characters on the next line.</p>	Page 5-49										
Faaaabcccc ddee	<p>Sequential Numbering. Allows the printing of sequencing fields (text, bar codes) where all incrementing is done within the printer.</p> <ul style="list-style-type: none"> aaaa = Number of times to repeat the same data (0001-9999) b = Plus or minus symbol (+ for increments; - for decrements) cccc = Value of step for sequence (001-9999) dd = No. of digits for sequential numbering (01-99, default = 8) ee = No. of digits free from sequential numbering (01-99, default = 0) 	Page 5-68										

INSTRUCTION	DESCRIPTION	PAGE
-------------	-------------	------

FWaaHbbbb **Horizontal Line.** Prints a horizontal line. Units of measurement are dots. Page 5-47

	M-8459S	M-8460S	M-8485S	M-8490S
aa = Width of Hor Line	01 to 99			
bbbb = Length of HorLine	0001 -0896	0001 to 1216	0001 -1024	0001 -1344

FWaabbVccc
Hdddd **Box.** Prints a box. For values aa, bbbb, cc, and dddd, see instructions for horizontal and vertical lines. Units of measurement are dots. Page 5-47

	M-8459S	M-8460S	M-8485S	M-8490S
aa = Width of Hor Side	01 to 99			
bb = Width of Vert Side	01 to 99			
cccc = Length of Vert Side Expanded	0001 -1424 0001 -2824			0001 - 2136 0001 - 4272
dddd = Length of Hor Side	0001 to 0896	0001 to 1216	0001 -1024	0001 -1344

FWccVddd **Vertical Line.** Prints a vertical line. Units of measurement are dots. Page 5-47

	M-8459S	M-8460S	M-8485S	M-8490S
cc = Width of Vert Line	01 to 99			
ddd = Length of Vert Line Expanded	0001-1424 0001 - 2848			

FXaaabccc
ddeeee **Data Matrix.** Sequential Numbering. Prints sequential numbered Data Matrix 2-D symbols. Page 5-99

- aaa = Number of duplicate labels (001-999)
- b = Increment or decrement
 - + Increment
 - Decrement
- ccc = Increment/decrement steps (001-999)
- ddd = Sequential numbering start position (001-999). Referenced to left side.
- eee = Incremented data length (001-999). Measured from start position.

Gabbcccc(data) **Custom Graphics.** Allows the creation and printing of graphic images using a dot-addressable matrix. Page 5-42

- a = Specifies format of data stream to follow
 - B Binary
 - H Hexadecimal
- bbb = Number of horizontal 8 x 8 blocks (see page 5-42 for range)
- ccc = Number of vertical 8 x 8 blocks (see page 5-42 for range)
- data = Data to describe the graphic image

GPaaaaa **PCX File.** Downloads PCX file to the internal graphics image memory. Page 5-44
 aaaaa = No. of bytes to be downloaded (max DOS file size = 32K)

INSTRUCTION	DESCRIPTION	PAGE										
Haaaa	<p>Horizontal Position. Specifies a field's horizontal location across the width of the label from the current base reference point. The units of measurement are dots.</p> <table border="1" style="width: 100%; border-collapse: collapse; margin-top: 10px;"> <thead> <tr> <th style="width: 40%;"></th> <th style="width: 15%;">M-8459S</th> <th style="width: 15%;">M-8460S</th> <th style="width: 15%;">M-8485S</th> <th style="width: 15%;">M-8490S</th> </tr> </thead> <tbody> <tr> <td>aaaa = New Horizontal Position</td> <td>0001 to 0896</td> <td>0001 to 1216</td> <td>0001-1024</td> <td>0001-1344</td> </tr> </tbody> </table>		M-8459S	M-8460S	M-8485S	M-8490S	aaaa = New Horizontal Position	0001 to 0896	0001 to 1216	0001-1024	0001-1344	Page 5-55
	M-8459S	M-8460S	M-8485S	M-8490S								
aaaa = New Horizontal Position	0001 to 0896	0001 to 1216	0001-1024	0001-1344								
IDaa	<p>Store Job ID. Stores the Job ID number.</p> <p>aa = Job ID number assigned (01-99)</p>	Page 5-45										
J	<p>Journal Print. Provides the ability to print text line by line. Fixed spacing between lines and characters.</p>	Page 5-46										
Kab90cc	<p>Recall Custom Designed Characters. Recalls for printing a custom character stored by the Tabcc(data) command.</p> <p>a = 1 16 x 16 matrix 2 24 x 24 matrix</p> <p>b = Indicates the format that data stream was stored in B Binary H Hexadecimal</p> <p>bb = Memory location where the character was stored. Valid locations are 21 to 52 or "!" to "R" in hex values.</p>	Page 5-21										
Laabb	<p>Character Expansion. Expands characters in both directions.</p> <p>aa = Multiple to expand horizontally (01-12) bb = Multiple to expand vertically (01-12)</p>	Page 5-23										
LD,a,b,c,d,e,f,g,i	<p>Download Protocol Command Codes. Downloads a user defined set of Alternate Protocol Command Codes. See Appendix F for details on the proper usage of this command.</p>	Page 5-93										
M	<p>Font type. Specifies the 13W x 20H dot matrix font (including descenders).</p>	Page 5-33										
N	<p>Rotate. Moving Base Reference Point. Sets the original base reference point and returns printing to normal orientation.</p>	Page 5-66										
OA	<p>Font type. Specifies the OCR-A font with dot matrix.</p> <table border="1" style="width: 100%; border-collapse: collapse; margin-top: 10px;"> <thead> <tr> <th style="width: 40%;"></th> <th style="width: 15%;">M-8459S</th> <th style="width: 15%;">M-8460S</th> <th style="width: 15%;">M-8485S</th> <th style="width: 15%;">M-8490S</th> </tr> </thead> <tbody> <tr> <td>OA Font Matrix</td> <td colspan="3" style="text-align: center;">15W x 22H</td> <td style="text-align: center;">22W x 33H</td> </tr> </tbody> </table>		M-8459S	M-8460S	M-8485S	M-8490S	OA Font Matrix	15W x 22H			22W x 33H	Page 5-33
	M-8459S	M-8460S	M-8485S	M-8490S								
OA Font Matrix	15W x 22H			22W x 33H								
OB	<p>Font type. Specifies the OCR-B font dot matrix.</p> <table border="1" style="width: 100%; border-collapse: collapse; margin-top: 10px;"> <thead> <tr> <th style="width: 40%;"></th> <th style="width: 15%;">M-8459S</th> <th style="width: 15%;">M-8460S</th> <th style="width: 15%;">M-8485S</th> <th style="width: 15%;">M-8490S</th> </tr> </thead> <tbody> <tr> <td>OB Font Matrix</td> <td colspan="3" style="text-align: center;">20 W x 24H</td> <td style="text-align: center;">30W x 36H</td> </tr> </tbody> </table>		M-8459S	M-8460S	M-8485S	M-8490S	OB Font Matrix	20 W x 24H			30W x 36H	Page 5-33
	M-8459S	M-8460S	M-8485S	M-8490S								
OB Font Matrix	20 W x 24H			30W x 36H								

INSTRUCTION	DESCRIPTION	PAGE										
Paa	Character Pitch. Designates the number of dots between characters. aa = Number of dots between characters (01-99)	Page 5-26										
PR	Fixed Font Spacing. Returns the printer to fixed character spacing mode.	Page 5-25										
PS	Proportional Font Spacing. Places the printer in the proportional character spacing mode. Will not work with U Font.	Page 5-28										
Qaaaaa	Print Quantity. Specifies the total number of labels to print. aaaaaa = Total number of labels to print for the job (000001-999999)	Page 5-57										
R	Rotate, Moving Base Reference Point. Rotates the printing of all subsequent images by 90 degrees counterclockwise each time it is used. Also moves the base reference point.	Page 5-66										
S	Font type. Specifies the 8W x 15H dot matrix font (including descenders).	Page 5-33										
Tabcc(data)	Store Custom Designed Characters. To create and store custom characters or images in the printer's volatile memory. See Kab90cc to recall the character for printing. a = 1 16 x 16 matrix 2 24 x 24 matrix b = Specifies data stream format to follow B Binary H Hexadecimal cc = Memory location to store the character. Valid locations are 21 to 52 or "!" to "R" in hex values. (data)= Data to describe the character.	Page 5-21										
U	Font type. Specifies a 5W x 9L dot matrix font (including descenders).	Page 5-33										
Vbbbb	Vertical Position. Specifies a field's vertical location down the length of the label from the current base reference point. Units of measurement are dots.	Page 5-55										
<table border="1" style="width: 100%; border-collapse: collapse;"> <thead> <tr> <th style="width: 30%;"></th> <th style="width: 15%;">M-8459S</th> <th style="width: 15%;">M-8460S</th> <th style="width: 15%;">M-8485S</th> <th style="width: 15%;">M-8490S</th> </tr> </thead> <tbody> <tr> <td style="padding: 5px;">bbbb = New Vert Position Expanded</td> <td></td> <td style="text-align: center; padding: 5px;">0001-1424 0001 - 2824</td> <td></td> <td style="text-align: center; padding: 5px;">0001-2136 0001 - 4272</td> </tr> </tbody> </table>				M-8459S	M-8460S	M-8485S	M-8490S	bbbb = New Vert Position Expanded		0001-1424 0001 - 2824		0001-2136 0001 - 4272
	M-8459S	M-8460S	M-8485S	M-8490S								
bbbb = New Vert Position Expanded		0001-1424 0001 - 2824		0001-2136 0001 - 4272								
WBa	Font type. Specifies the 18W x 30L dot matrix font (including descenders). a = 0 Disables auto-smoothing of font 1 Enables auto-smoothing if expansion is greater than 3	Page 5-37										

INSTRUCTION	DESCRIPTION	PAGE
WDHaaaaVbbbb XccccYdddd	Copy Image Area. To copy an image to another location of the label. aaaa = Horizontal position of the top left corner of image area bbbb = Vertical position of the top left corner of image area cccc = Horizontal length of image area dddd = Vertical length of image area	Page 5-31
WLa	Font type. Specifies the 28W x 52L dot matrix font (including descenders). a = 0 Disables auto-smoothing of font 1 Enables auto-smoothing if expansion is greater than 3	Page 5-37
XM	Font type. Specifies the 24W x 24H dot matrix font (including descenders).	Page 5-33
XS	Font type. Specifies the 17W x 17H dot matrix font (including descenders).	Page 5-33
XU	Font type. Specifies the 5W x 9L dot matrix font (including descenders).	Page 5-33
XWa	Font type. Specifies the 48W x 48L dot matrix font (including descenders). a = 0 Disables auto-smoothing of font 1 Enables auto-smoothing if expansion is greater than 3	Page 5-37
XBa	Font type. Specifies the 48W x 48L dot matrix font (including descenders). a = 0 Disables auto-smoothing of font 1 Enables auto-smoothing if expansion is greater than 3	Page 5-37
Z	Stop Code. Ends all print jobs.	Page 5-70
%a	Rotate. Fixed Base Reference Point. Rotates printing in 90° increments without changing the base reference point. a = 0 Sets print to normal direction 1 Sets print to 90° CCW 2 Sets print to 180° rotated (upside down) 3 Sets print to 270° CCW (90° CW)	Page 5-64

INSTRUCTION	DESCRIPTION	PAGE															
\$a,b,c,d	<p>Vector font. Specifies printing of the unique SATO vector font.</p> <ul style="list-style-type: none"> a = A Helvetica Bold (proportional spacing) B Helvetica Bold (fixed spacing) b = Font width (50-999 dots*) c = Font height (50-999 dots*) d = Font variation (0-9) as follows: <ul style="list-style-type: none"> 0 Standard 1 Standard open (outlined) 2 Gray (mesh) pattern 1 3 Gray (mesh) pattern 2 4 Gray (mesh) pattern 3 5 Standard, shadow 1 6 Standard, shadow 2 7 Standard mirror image 8 Italic 9 Italic open (outlined) 	Page 5-35															
\$=(data)	<p>Data for Vector font.</p>	Page 5-35															
#Ea	<p>Print Darkness. Specifies a new print darkness setting. The lightest setting is "1". There are three darkness levels that can be specified.</p> <table border="1" style="width: 100%; border-collapse: collapse; margin-top: 10px;"> <thead> <tr> <th style="width: 30%;"></th> <th style="width: 15%;">M-8459S</th> <th style="width: 15%;">M-8460S</th> <th style="width: 15%;">M-8485S</th> <th style="width: 15%;">M-8490S</th> </tr> </thead> <tbody> <tr> <td>a = Print Darkness</td> <td>1, 2, 3, 4, or 5</td> <td>1, 2 or 3</td> <td>1, 2 or 3</td> <td>1, 2 or 3</td> </tr> </tbody> </table>		M-8459S	M-8460S	M-8485S	M-8490S	a = Print Darkness	1, 2, 3, 4, or 5	1, 2 or 3	1, 2 or 3	1, 2 or 3	Page 5-52					
	M-8459S	M-8460S	M-8485S	M-8490S													
a = Print Darkness	1, 2, 3, 4, or 5	1, 2 or 3	1, 2 or 3	1, 2 or 3													
(aaaa,bbbb	<p>Reverse Image. Reverse image from black to white and vice versa. Units of measure are dots.</p> <table border="1" style="width: 100%; border-collapse: collapse; margin-top: 10px;"> <thead> <tr> <th style="width: 30%;"></th> <th style="width: 15%;">M-8459S</th> <th style="width: 15%;">M-8460S</th> <th style="width: 15%;">M-8485S</th> <th style="width: 15%;">M-8490S</th> </tr> </thead> <tbody> <tr> <td>aaaa = Hor Length</td> <td>0001-0896</td> <td>0001 to 1216</td> <td>0001-1024</td> <td>0001-1344</td> </tr> <tr> <td>bbbb = Vert Length Expanded</td> <td></td> <td>0001-1424 0001 - 2848</td> <td></td> <td>0001-2136 0001 - 4272</td> </tr> </tbody> </table>		M-8459S	M-8460S	M-8485S	M-8490S	aaaa = Hor Length	0001-0896	0001 to 1216	0001-1024	0001-1344	bbbb = Vert Length Expanded		0001-1424 0001 - 2848		0001-2136 0001 - 4272	Page 5-62
	M-8459S	M-8460S	M-8485S	M-8490S													
aaaa = Hor Length	0001-0896	0001 to 1216	0001-1024	0001-1344													
bbbb = Vert Length Expanded		0001-1424 0001 - 2848		0001-2136 0001 - 4272													
&	<p>Store Form Overlay. Stores a specified label image in the printer's volatile form overlay memory.</p>	Page 5-41															
/	<p>Recall Form Overlay. Recalls the label image from the printer's formoverlay memory for printing.</p>	Page 5-40															
0 (zero)	<p>Replace Data (Partial Edit). Provides the ability to replace a specified area of the previous label with new data.</p>	Page 5-60															
*a	<p>Clear Print Job(s) and Memory. Clears individual memory and buffers.</p> <ul style="list-style-type: none"> a = When not included in command, clears print jobs in Multi-Buffer mode. a = If included in command, specifies memory section to be cleared <ul style="list-style-type: none"> T Custom character memory, printer & Form overlay memory, printer X Clears all memory all memory and buffers 	Page 5-29															

INSTRUCTION	DESCRIPTION	PAGE
@	Off-Line. Signals the printer to go off-line after the completion of a print job.	

Calendar Option Commands

WA(elements)	Calendar Print. Prints the date and/or time field (up to 16 characters) from the printer's internal clock. Use slash to separate date elements and colon to separate time elements. elements = YY Year MM Month DD Day hh Hour mm Minutes	Page 5-74
WPabbb	Calendar Increment. To add a value to the printer's current date and/or time. Does not change the printer's internal time setting. a = Y Years M Months D Days h Hours bbb = Numeric data, Years (1-9), Months (01-99), Days (001-999), Hours (001-999).	Page 5-72
WTAabbbccdee	Calendar Set. To set the time and date of the printer's internal clock. aa = Year (00-99) bb = Month (01-12) cc = Day (01-31) dd = Hour (00-23) ee = Minute (00-59)	Page 5-76

Memory Card Option Commands

BJ(aa..abb..b)	Start TrueType Font Storage. Prepares the Memory Card to accept TrueType font data. aa...a = 40 byte font description bb...b = 10 byte date field	Page 5-82
BJDccccccddd ee...e	Download TrueType Font Data. Downloads the TrueType font data to the memory area specified. ccccc = Memory Offset (hexadecimal) dddd = Data size in bytes (max = 2000) ee...e = Font data to be downloaded	Page 5-82
BJ)	End TrueType Font Storage. Ends the TrueType font storage process	Page 5-82
BJFaaaaaaaa	Initialize Memory Card. Initializes the Memory Card and formats it for use. Should be preceded by the Slot Select command for the card to be initialized. aaaaaaaaa = 8 character alphanumeric password	Page 5-90

INSTRUCTION	DESCRIPTION	PAGE
BJRabbccdd eeeff..f	TrueType Font Recall. Recalls a previously stored TrueType font for use. a = Font ID (1-9) bb = Horizontal Expansion (01-12) cc = Vertical Expansion (01-12) dd = Character pitch (01-99) eeee = Number of characters ff..f = Data to be printed using font	Page 5-81
BJS	Memory Card Status. Reports the status of the currently active Memory Card to the host by printing a status label.	Page 5-92
CCa	Slot Select. Selects the Memory Card slot for all following Memory Card commands. a = 1 Slot 1 b = 2 Slot 2	Page 5-91
EXa	Expand Memory Area. Expands the memory area used by the printer to image the label. a = 0 Return to using internal printer RAM 1 Use Memory Card in Slot 1 2 Use Memory Card in Slot 2	Page 5-79
Glabbbccddd ee...e	Store Custom Graphics. Stores a graphic image in the memory card to be called later for printing on a label. a = Specifies format of data stream to follow B Binary H Hexadecimal bbb = Number of horizontal 8 x 8 blocks ccc = Number of vertical 8 x 8 blocks ddd = Graphics storage number (001-999) ee...e = Data to describe the graphic image	Page 5-86
GRccc	Recall Custom Graphics. Recalls for printing the graphic image stored by the GI command. ccc = Storage number (001-999)	Page 5-85
Plaaa,bbbb, cc...c	Store PCX Graphics File. Stores a PCX graphic file. aaa = Storage number (001-999) bbbb= Number of bytes in the file to be stored.	Page 5-89
PYaaa	Recall PCX Graphics File. Recalls a PCX graphics file. aaa = The storage number assigned to the file (001-999)	Page 5-88
YR,aaa /D,bb,cc...c	Recall Format/Field. To recall a field from a format previously stored in the memory card. aaa = Number of format to be recalled (001 to 999) bb = Number of field to be recalled (01-99) cc...c = Data to be placed in field.	Page 5-83

YS,aaa /Nbb,cc	Store Format/Field. To store a field in a format in the memory card. aaa = Format number (001 -999) bb = Field number (01-99) cc = Number of characters in the field	Page 5-84
*a,bbb	Clear Card Memory. Clears individual memory and buffer areas. a = Memory section to be cleared G SATO graphic files (001-999) P PCX graphic file (001-999) F Stored formats (001-999) O TrueType fonts, memory card (001-009) bbb = Storage number	Page 5-78

APPENDIX B. BAR CODE SPECIFICATIONS

BAR CODE SYMBOLOGIES

This section contains detailed information on the printing of bar codes on the “S” Series printers. Information on printing the following bar code symbologies is provided:

- Codabar
- Code 39
- Interleaved 2 of 5
- UPC-A/EAN-13
- EAN-8
- Industrial 2 of 5
- Matrix 2 of 5
- Code 128
- MSI
- Code 93
- UPC-E
- UPC Supplements(Bookland)
- UCC-128
- Postnet
- Data Matrix
- Maxicode
- PDF417

Codabar

Command Structure

1:3 ratio <ESC>**B0bbcccd (data) d**
 2:5 ratio <ESC>**BD0bbcccd (data) d**
 1:2 ratio <ESC>**D0bbcccd (data) d**

bb = Width of narrow element in dots (01-12)
 ccc = Bar height in dots (001-600)
 d = Required Start and Stop character (A, B, C, or D)
 (data) = Bar code data (alphanumeric)

Character Set

0-9, -, \$, :, /, +
 A, B, C, D (Start/Stop characters)

Density Table

Printer Model	Narrow/Wide Ratio	Value of "bb"	"X" Dimension (mils)	Density (char/inch)
M-8490S	1:3	01	3.3	25.0
	1:3	02	6.7	12.6
	2:5	01	6.7	13.6
	1:2	02	3.3	15.1
M-8459S M-8460S M-8485S	1:3	01	5.0	16.9
	1:3	02	10.0	8.5
	2:5	01	10.0	9.2
	1:2	02	5.0	10.2

Example

<ESC>H0400<ESC>V0025<ESC>**B002100A12345B**
 <ESC>H0440<ESC>V0135<ESC>XS12345

Notes

You must add the appropriate (A, B, C or D) Start and Stop characters to the data string. The printer does not automatically add them when printing.



Code 39

Command Structure
 1:3 ratio: <ESC>B**bbccc*** (data) *
 2:5 ratio: <ESC>BD**1bbccc*** (data) *
 1:2 ratio: <ESC>D**1bbccc*** (data) *

bb = Width of narrow element in dots (01-12)
 ccc = Bar height in dots (001-600)
 * = Required Start and Stop character (asterisk)
 (data) = Bar code data (alphanumeric)

Character Set
 0-9, A-Z, Space, \$, %, +, -, ., /
 * (Start/Stop character)

Density Table

Printer Model	Narrow/ Wide Ratio	Value of "bb"	"X" Dimension (mils)	Density (char/inch)
M-8490S	1:3	01	3.3	18.8
	1:3	02	6.7	9.5
	2:5	01	3.3	10.3
	1:2	01	6.7	23.1
	1:2	02	3.3	11.5
M-8459S M-8460S M-8485S	1:3	01	5.0	12.7
	1:3	02	10.0	6.4
	2:5	01	10.0	7.0
	1:2	01	5.0	15.6
	1:2	02	10.0	7.8

Example
 <ESC>H0100<ESC>V0025<ESC>B**103100***CODE 39*
 <ESC>H0230<ESC>V0130<ESC>XS*CODE 39*

Notes
 You must add the "*" Start/Stop characters to the data stream. The printer does not add them automatically.



Interleaved Two of Five (I 2/5)

Command Structure

1:3 ratio: <ESC>**B2bbccc (data)**
 2:5 ratio: <ESC>**BD2bbccc (data)**
 1:2 ratio: <ESC>**D2bbccc (data)**

bb = Width of narrow element in dots (01-12)
 ccc = Bar height in dots (001-600)
 (data) = Bar code data (numeric); must be an even number of digits or else the printer will add a leading zero; start and stop code are provided by the printer

Character Set 0-9 (numeric only)

Density Table

Printer Model	Narrow/Wide Ratio	Value of "bb"	"X" Dimension (mils)	Density (char/inch)
M-8490S	1:3	01	3.3	33.4
	1:3	02	6.7	16.7
	2:5	01	3.3	18.8
	1:2	01	6.7	21.4
	1:2	02	3.3	14.3
M-8459S M-8460S M-8485S	1:3	01	5.0	22.6
	1:3	02	10.0	11.3
	2:5	01	10.0	12.7
	1:2	01	5.0	14.5
	1:2	02	10.0	9.7

Example

<ESC>H0100<ESC>V0100<ESC>**B20310045676567**
 <ESC>H0140<ESC>V0210<ESC>XM4567 6567

Notes

To add horizontal guard bars to the top and bottom of the bar code, use the Line and Box command (see page 5-47).



UPC-A/EAN-13

Command Structure <ESC>**B3bbccc (data)**
 <ESC>**D3bbccc (data)**
 <ESC>**BD3bbccc (data)**

bb = Width of narrow element in dots (01-03)
 ccc = Bar height in dots (001-600)
 (data) = Bar code data (numeric); must be exactly 13 digits. For
 UPC-A, the first digit must be a zero and the last 11 digits
 are the actual UPC-A data followed by a check digit.

To select UPC-A, 11 digits of data is sent. The printer adds a "0" and automatically generates the check digit. If 12 digits of data are sent, the printer assumes an EAN-13 symbol and automatically generates the check digit. The last digit of the bar code data is a modulo 10 check digit. If 13 digits of data are sent to the printer, the check digit is not created and must be supplied by the programmer. It must be the last character in the 13 digit string and can be determined by using the calculations outlined below.

Character Set 0-9 (numeric only)

Density Table

Printer Model	Value of "bb"	Narrow Bar Width (mils)	Magnification Factor
M-8490S	02	6.7	Below Minimum
	03	10.0	75%
	04	13.3	100%
M-8459S M-8460S M-8485S	02	10.0	75%
	03	15.0	112%
	04	20.0	150%

Notes D3 provides guide bars that extend longer than the rest of the bar code. BD3 provides guide bars and the human readable text below the symbol.

Example <ESC>H0100<ESC>V0375<ESC>**BD30215001234567890**



**Calculating the
Mod 10 Check Digit**

If you wish to encode the UPC-A data "01234567890", follow these steps to find the correct check digit.

ODD	0		2		4		6		8		0	
EVEN		1		3		5		7		9		CD

1. First add all the numbers in the ODD positions.
i.e., $0+2+4+6+8+0 = 20$
2. Multiply the result of Step 1 by 3.
i.e., $20 \times 3 = 60$
3. Add up all the numbers in the EVEN positions.
i.e., $1+3+5+7+9 = 25$
4. Add the result of Step 2 to that of Step 3.
i.e., $60 + 25 = 85$
5. Subtract the result of Step 4 from the next highest increment of 10.
i.e., $90 - 85 = 5$
6. The correct Modulo 10 check digit for the 11 digit string "01234567890" is 5.

EAN-8

Command Structure <ESC>**B4bbccc (data)**
 <ESC>**D4bbccc (data)**

bb = Width of narrow element in dots (01-03)
 ccc = Bar height in dots (001-600)
 (data) = Bar code data (numeric); must be exactly 8 digits.

Character Set 0-9 (numeric only)

Density Table

Printer Model	Value of "bb"	Narrow Bar Width (mils)	Magnification Factor
M-8490S	02	6.7	Below Minimum
	03	10.0	75%
	04	13.3	100%
M-8459S M-8460S M-8485S	02	10.0	75%
	03	15.0	112%
	04	20.0	150%

- Notes**
1. D4 provides guide bars that extend longer than the rest of the bar code and the human readable text below the symbol.
 2. The check digit is automatically calculated for EAN-8.

Example <ESC>H0400<ESC>V0375<ESC>**BD4031001234567**



Industrial Two of Five

Command Structure 1:3 ratio: **B5bbccc (data)**
 2:5 ratio: **BD5bbccc (data)**
 1:2 ratio: **D5bbccc (data)**

bb = Width of narrow element in dots (01-12)
ccc = Bar height in dots (001-600)
(data) = Bar code data (numeric); must be an even number of digits or
 else the printer will add a leading zero

Character Set 0-9 (numeric only)

Notes To add horizontal guard bars to the top and bottom of the bar code,
 use the Line and Box command (see Page 5-47).

Example <ESC>H0100<ESC>V0600<ESC>**BD50310012345**
 <ESC>H0300<ESC>V0710<ESC>XS12345



12345

Matrix Two of Five

- Command Structure**
- 1:3 ratio: <ESC>**B6bbccc (data)**
 - 2:5 ratio: <ESC>**BD6bbccc (data)**
 - 1:2 ratio: <ESC>**D6bbccc (data)**
- bb = Width of narrow element in dots (01-12)
ccc = bar height in dots (001-600)
(data) = Bar code data (numeric only); must be an even number of digits or else the printer will add a leading zero.
- Character Set** 0-9 (numeric only)
- Notes** To add horizontal guard bars to the top and bottom of the bar code, use the Line and Box command (see Page 5-47).
- Example**
- ```
<ESC>H0100<ESC>V0775<ESC>BD60310012345
<ESC>H0230<ESC>V0885<ESC>XS12345
```



# Code 128

**Command Structure**    <ESC>**BGbbccdd (data)**

- bb    = Width of narrow element in dots (01-12)
- ccc   = Bar height in dots (001-600)
- dd    = Start code to specify initial subset of bar code data
  - >G    Subset A Start code
  - >H    Subset B Start code
  - >I    Subset C Start code
- (data) = Includes bar code data and subset Shift codes; Shift codes are used to change the subset type within the bar code data.  
 Shift codes:
  - >E    Subset A Shift code
  - >D    Subset B Shift code
  - >C    Subset C Shift code

**Character Set**                    See Code 128 Character Table on Page B-18

**Density Table**

| Printer Model | Value of "bb" | "X" Dimension (mils) | Density (char/inch) |          |
|---------------|---------------|----------------------|---------------------|----------|
|               |               |                      | Subsets A, B        | Subset C |
| M-8490S       | 01            | 3.3                  | 27.3                | 54.7     |
|               | 02            | 6.7                  | 13.6                | 27.2     |
|               | 03            | 10                   | 9.1                 | 18.3     |
| M-8459S       | 01            | 5.0                  | 18.2                | 36.5     |
| M-8460S       | 01            | 10.0                 | 9.1                 | 18.3     |
| M-8485S       |               | 15.0                 | 13.8                | 12.2     |

**Example**                    The following will start in Subset A for the characters "AB", shift to Subset B for "789", then shift to Subset C for "123456".

```
<ESC>H0200<ESC>V0550<ESC>BG03100>GAB>B789>C123456
<ESC>H0310<ESC>V655<ESC>XSAB789123456
```



---

# MSI

---

**Command Structure**

1:3 ratio: <ESC>**B**Abbccc (data) d  
2:5 ratio <ESC>**B**DAbbccc (data) d  
1:2 ratio <ESC>**D**Abbccc (data) d

bb = Width of narrow element in dots (01-12)  
ccc = Bar height in dots (001-600)  
(data) = Bar code data (numeric); maximum of 15 digits  
d = Required check digit

**Character Set** 0-9 (numeric only)

**Example** <ESC>H0100<ESC>V0950<ESC>**BA03100123455**  
<ESC>H0170<ESC>V1060<ESC>XS12345



# Code 93

**Command Structure**    1:3 ratio: <ESC>BCbbccdd (data)

bb    = Width of narrow element in dots (01-12)  
 ccc   = Bar height in dots (001-600)  
 dd    = Length of data (number of digits, 00-99)  
 (data) = Bar code data (alphanumeric); length must match value of parameter "dd"; check digit is supplied by printer

**Character Set**            0-9, A-Z, -, ., Space, \$, /, +, %

**Density Table**

| Printer Model                 | Narrow/Wide Ratio | Value of "bb" | "X" Dimension (mils) | Density (char/inch) |
|-------------------------------|-------------------|---------------|----------------------|---------------------|
| M-8490S                       | 1:3               | 01            | 3.3                  | 33.3                |
|                               | 1:3               | 02            | 6.7                  | 16.7                |
|                               | 1:3               | 03            | 10                   | 11.1                |
| M-8459S<br>M-8460S<br>M-8485S | 1:3               | 01            | 5.0                  | 22.5                |
|                               | 1:3               | 02            | 10.0                 | 11.3                |
|                               | 1:3               | 03            | 15                   | 7.5                 |

**Example**

<ESC>H0100<ESC>V1125<ESC>BC03100081234ABCD  
 <ESC>H0155<ESC>V1240<ESC>XS1 234ABCD



1234ABCD

# UPC-E

**Command Structure**    <ESC>**BE**bbccc (data)  
                              <ESC>**DE**bbccc (data)

bb     = Width of narrow element in dots (01-03)  
 ccc    = Bar height in dots (001-600)  
 (data) = Bar code data (numeric); must be exactly 6 digits

**Character Set**            0-9 (numeric only)

**Density Table**

| Printer Model | Value of "bb" | Narrow Bar Width (mils) | Magnification Factor |
|---------------|---------------|-------------------------|----------------------|
| M-8490S       | 02            | 6.7                     | Below Minimum        |
|               | 03            | 10.0                    | 75%                  |
|               | 04            | 13.3                    | 100%                 |
| M-8459S       | 02            | 10.0                    | 75%                  |
| M-8460S       | 03            | 15.0                    | 112%                 |
| M-8485S       | 04            | 20.0                    | 150%                 |

**Notes**                      Command **DE** provides guide bars that extend longer than the rest of the bar code.

**Example**                    <ESC>H0400<ESC>V0550<ESC>**DE03100123456**  
                                  <ESC>H0375<ESC>V0600<ESC>OB0  
                                  <ESC>H0408<ESC>V0655<ESC>OB123456



# Bookland (UPC/EAN Supplements)

**Command Structure**    <ESC>BFbbccc (data)

- bb     = Width of narrow element in dots (01-03)
- ccc    = Bar height in dots (001-600)
- (data) = Bar code data (numeric); must be exactly 2 or 5 digits

**Character Set**            0-9 (numeric only)

**Density Table**

| Printer Model | Value of "bb" | Narrow Bar Width (mils) | Magnification Factor |
|---------------|---------------|-------------------------|----------------------|
| M-8490S       | 02            | 6.7                     | Below Minimum        |
|               | 03            | 10.0                    | 75%                  |
|               | 04            | 13.3                    | 100%                 |
| M-8459S       | 02            | 10.0                    | 75%                  |
| M-8460S       | 03            | 15.0                    | 112%                 |
| M-8485S       | 04            | 20.0                    | 150%                 |

**Example**

```

<ESC>H0325<ESC>V0725<ESC>D30315009827721123
<ESC>L0101<ESC>H0295<ESC>V0800<ESC>OB0
<ESC>H0340<ESC>V0878<ESC>OB98277
<ESC>H 0480<ESC>V0878<ESC>OB21123
<ESC>H640<ESC>V0760<ESC>BF0313021826
<ESC>H655<ESC>V0730<ESC>OB21826

```



---

# UCC-128

---

**Command Structure**    <ESC>**B|bbcccd (data)**

- bb     =   Width of the narrow elements in dots (01 to 12)  
ccc    =   Bar height in dots (001 to 600)  
d       =   Placement of human readable text  
          0   None  
          1   Text at top of bar code  
          2   Text at bottom of bar code  
(data) =   17 digits made up of the following:  
          1st digit = Container type  
          digits 2-8, Shipper identification  
          digits 9-17, Container Sequential number  
          Note: The Container Sequential number is not automatically  
          sequenced by the printer.

**Character Set**                   See Code 128 Character Table on Page B-18

**Density Table**                   See Code 128, Page B-10

- Notes**
1. The Start, Function, Stop and Extension codes will be created by the printer and added automatically.
  2. The internal Modulo 10 check character will be automatically created and added by the printer. The overall Code 128 symbol check character will be automatically created by the printer and added.
  3. The automatically created human readable text will be created according to the following rules:
    - The spacing between the bar code and the text is fixed at 10 dots (.050 inches).
    - If the width of the human readable text is wider than the bar code, it will start at the same position as the bar code and extend past the right of the bar code.
    - If the width of the human readable text is less than the bar code, it will be centered on the bar code.
    - The automatically generated human readable font is OCR-B.
    - If any part of the human readable text extends outside the printable area, none of it will be printed. Care should be exercised when placing the bar code to allow for any automatically created human readable text.

**Example**

Without incrementing

<ESC>A  
<ESC>H0100<ESC>V0100<ESC>BI04150101234567000000001  
<ESC>Q2<ESC>Z



With incrementing

<ESC>A  
<ESC>H0100<ESC>V0100<ESC>F001+001  
<ESC>BI04150101234567000000001  
<ESC>Q2<ESC>Z



---

# Postnet

---

**Command Structure**    <ESC>BP (data)

- data    =    5 digits ZIP
- =    6 digits for Postnet 37
- =    9 digits for ZIP+4
- =    11 digits for Delivery Point Bar Code

**Character Set**        1-9 (numeric only)

- Notes**
1. Frame bits and check digits added automatically by printer.
  2. Bar code width and height are fixed and cannot be changed.
  3. If the number of digits sent to the printer as data does not match one of the formats specified above (i.e. 5, 6, 9 or 11), the command is ignored and nothing will be printed.
  4. If a “-” is included in the data stream (i.e. 84093-1565), it is ignored.

**Example**

```
<ESC>H0100<ESC>V0120<ESC>BP94089
<ESC>H0100<ESC>V0160<ESC>BP123456
<ESC>H0100<ESC>V0200<ESC>BP123456789
<ESC>H0100<ESC>V0240<ESC>BP12345678901
```



# Data Matrix

| Command Structure | Data Format | <ESC>BXaabbccddeeffghh                                                                                            |
|-------------------|-------------|-------------------------------------------------------------------------------------------------------------------|
| aa                | =           | Format ID. 01-06 or 11-16. The values 07 and 17 will not be accepted by the printer.                              |
| bb                | =           | Error correction level. 00 ,01, or 04-14. The values 02, 03 or values of 15 or greater will be processed as a 00. |
| cc                | =           | Horizontal cell size. 03 - 12 dots/cell.                                                                          |
| dd                | =           | Vertical cell size. 03 - 12 dots/cell.                                                                            |
| eee               | =           | Number of cells in one line. Must use 000 to optimize.                                                            |
| fff               | =           | Number of cell lines. Must use 000 to optimize.                                                                   |
| g                 | =           | Mirror Image                                                                                                      |
|                   |             | 0 = Normal Print                                                                                                  |
|                   |             | 1 = Reverse Print                                                                                                 |
| hh                | =           | Guide Cell Thickness. 01-15. 01 indicates normal type.                                                            |

## Sequential Numbering <ESC>FXaaabccdddeee

|     |   |                                                                             |
|-----|---|-----------------------------------------------------------------------------|
| aaa | = | Number of duplicate labels to be printed (001 - 999)                        |
| b   | = | Increment or Decrement                                                      |
|     |   | + = Increment                                                               |
|     |   | - = Decrement                                                               |
| ccc | = | Increment/Decrement Steps (001 - 999)                                       |
| ddd | = | Sequential numbering start position (001 - 999)<br>Referenced to left side. |
| eee | = | Incremented data length measured from start position (001 - 999)            |

## Print Data <ESC>DCxxx...x

|        |   |                                 |
|--------|---|---------------------------------|
| xx...x | = | Data, maximum of 500 characters |
|--------|---|---------------------------------|



## Character Set

| ID NUMBER         | CHARACTER SET                                        | ENCODING SCHEME |
|-------------------|------------------------------------------------------|-----------------|
| <b>16 Bit CRC</b> |                                                      |                 |
| 01                | Numeric, Space                                       | Base 11         |
| 02                | Upper Case Alpha, Space                              | Base 27         |
| 03                | Upper Case Alpha, Space, Comma, Period, Slash, Minus | Base 41         |
| 04                | Upper Case Alphanumeric, Space                       | Base 37         |
| 05                | ASCII 7-bit, Full Keyboard (20H - 7FH)               | ASCII           |
| 06                | ISO 8-bit, International (20H - FFH)                 | 8-Bit           |
| <b>32 Bit CRC</b> |                                                      |                 |
| 11                | Numeric, Space                                       | Base 11         |
| 12                | Upper Case Alpha, Space                              | Base 27         |
| 13                | Upper Case Alpha, Space, Comma, Period, Slash, Minus | Base 41         |
| 14                | Upper Case Alphanumeric, Space                       | Base 37         |
| 15                | ASCII 7-bit, Full Keyboard (20H - 7FH)               | ASCII           |
| 16                | ISO 8-bit, International (20H - FFH)                 | 8-Bit           |

### Notes

See AIM USA Technical Specification Data Matrix for information on the structure of this symbology.

### Example

```

<ESC>V0100<ESC>H0100
<ESC>BX0505101000000001
<ESC>DCDATA MATRIX DATA MATRIX

```

# Maxicode

**Command Structure**    <ESC>BUaaa,bbb,cccc,dddd,eee..e

aaa            =    Service class, numeric only (001-999)  
 bbb            =    Country code, numeric only (001-999)  
 ccccc =    ZIP code, alphanumeric (000000-999999)  
 dddd          =    Extended ZIP code, numeric only (0001-9999)  
 ee...e       =    Low priority message, alphanumeric, 84 digits.

**Character Set**            Field dependent.

|               |              |
|---------------|--------------|
| Service Class | Numeric      |
| Country Code  | Numeric      |
| ZIP Code      | Alphanumeric |
| Message       | Alphanumeric |

**Notes**                      See AIM USA Uniform Symbology Specification - Maxicode for information on the structure of this symbology.

**Example**

```

<ESC>A<ESC>V0100<ESC>H0200<ESC>BU001,840,94089,0000,
])><Rs>
01<Gs>96
1Z12345675
<Gs>UPSN<Gs>12345E<Gs>089
<Gs><Gs>1/1<Gs>10.1<Gs>Y
<Gs><Gs><Gs>UT
<Rs><Eot>
!!!!!!!!!!!!!!!!!!!!!!!!!!!!!!
<ESC>Q1<ESC>Z

```



---

# PDF417

---

|                          |                                                                                                                                               |
|--------------------------|-----------------------------------------------------------------------------------------------------------------------------------------------|
| <b>Command Structure</b> | <ESC> <b>B</b> Faabbcddeefffnnn...n                                                                                                           |
|                          | aa = Minimum module dimension (03-09 dots). Will not print if values of 01, 02 or greater than 10 are specified.                              |
|                          | bb = Minimum module pitch dimension (04-24 dots). Will not print if values of 01, 02, 03 or greater than 25 are specified.                    |
|                          | c = Security (error detection) Level (1-8).                                                                                                   |
|                          | dd = Code words per line (01-30). If 00 is specified for both dd and ee, the printer automatically optimizes the number of rows per symbol.   |
|                          | ee = Rows per symbol (00 or 03-40). If 00 is specified for both dd and ee, the printer automatically optimizes the number of rows per symbol. |
|                          | fff = Number of characters to be encoded (0001-2700).                                                                                         |
|                          | nn...n = Data to be printed.                                                                                                                  |
| <b>Character Set</b>     | ASCII 128 character set plus PC437 Extended Character set.                                                                                    |
| <b>Notes</b>             | See AIM USA Uniform Symbology Specification PDF417 for information on the structure of this symbology.                                        |
| <b>Example</b>           | <ESC>V0100<ESC>H0100<ESC> <b>BK0607400000021PDF417 PDF417 PDF417</b>                                                                          |



## CODE 128 CHARACTER TABLE

---

The Code 128 Table lists 105 data values for the three subsets: A, B, and C. Each subset column displays either a single column of data or a double column of data.

- If the subset column displays a single column of data, that is the data to be entered to produce the result.
- If the subset column displays a double column of data, the first column contains the desired output, and the second column contains the actual characters to be entered.

For example, look at value 99 in the table:

If you are currently using Subset A or Subset B, you can change to Subset C by encoding ">C".

| VALUE | SUBSET A    | SUBSET B    | SUBSET C    |
|-------|-------------|-------------|-------------|
| 99    | Subset C >C | Subset C >C | 99          |
| 100   | Subset B >D | FNC4 >D     | Subset B >D |
| 101   | FNC4 >E     | Subset A >E | Subset A >E |
| 102   | FNC1 >F     | FNC1 >F     | FNC1 >F     |

Note: When Subset C is chosen, you must specify an even number of data positions because of the interleaved encodation method.

### Code 128 Character Table

| VALUE | SUBSET A | SUBSET B | SUBSET C | VALUE | SUBSET A     | SUBSET B   | SUBSET C |
|-------|----------|----------|----------|-------|--------------|------------|----------|
| 0     | SP       | SP       | 00       | 36    | D            | D          | 36       |
| 1     | !        | !        | 01       | 37    | E            | E          | 37       |
| 2     | "        | "        | 02       | 38    | F            | F          | 38       |
| 3     | #        | #        | 03       | 39    | G            | G          | 39       |
| 4     | \$       | \$       | 04       | 40    | H            | H          | 40       |
| 5     | %        | %        | 05       | 41    | I            | I          | 41       |
| 6     | &        | &        | 06       | 42    | J            | J          | 42       |
| 7     | '        | '        | 07       | 43    | K            | K          | 43       |
| 8     | (        | (        | 08       | 44    | L            | L          | 44       |
| 9     | )        | )        | 09       | 45    | M            | M          | 45       |
| 10    | *        | *        | 10       | 46    | N            | N          | 46       |
| 11    | +        | +        | 11       | 47    | O            | O          | 47       |
| 12    | ,        | ,        | 12       | 48    | P            | P          | 48       |
| 13    | -        | -        | 13       | 49    | Q            | Q          | 49       |
| 14    | .        | .        | 14       | 50    | R            | R          | 50       |
| 15    | /        | /        | 15       | 51    | S            | S          | 51       |
| 16    | 0        | 0        | 16       | 52    | T            | T          | 52       |
| 17    | 1        | 1        | 17       | 53    | U            | U          | 53       |
| 18    | 2        | 2        | 18       | 54    | V            | V          | 54       |
| 19    | 3        | 3        | 19       | 55    | W            | W          | 55       |
| 20    | 4        | 4        | 20       | 56    | X            | X          | 56       |
| 21    | 5        | 5        | 21       | 57    | Y            | Y          | 57       |
| 22    | 6        | 6        | 22       | 58    | Z            | Z          | 58       |
| 23    | 7        | 7        | 23       | 59    | [            | [          | 59       |
| 24    | 8        | 8        | 24       | 60    | \            | \          | 60       |
| 25    | 9        | 9        | 25       | 61    | ]            | ]          | 61       |
| 26    | :        | :        | 26       | 62    | ^            | ^          | 62       |
| 27    | ;        | ;        | 27       | 63    | _            | _          | 63       |
| 28    | <        | <        | 28       | 64    | NUL >(space) | ' >(space) | 64       |
| 29    | =        | =        | 29       | 65    | SOH >!       | a >!       | 65       |
| 30    | >        | >        | 30       | 66    | STX >"       | b >"       | 66       |
| 31    | ?        | ?        | 31       | 67    | ETX >#       | c >#       | 67       |
| 32    | @        | @        | 32       | 68    | EOT >\$      | d >\$      | 68       |
| 33    | A        | A        | 33       | 69    | ENQ >%       | e >%       | 69       |
| 34    | B        | B        | 34       | 70    | ACK >&       | f >&       | 70       |
| 35    | C        | C        | 35       | 71    | BEL >'       | g >'       | 71       |

### Code 128 Character Table (cont'd)

| VALUE | SUBSET<br>A | SUBSET<br>B | SUBSET<br>C | VALUE | SUBSET<br>A            | SUBSET<br>B | SUBSET<br>C |
|-------|-------------|-------------|-------------|-------|------------------------|-------------|-------------|
| 72    | BS >(       | h >(        | 72          | 89    | EM >9                  | y >9        | 89          |
| 73    | HT >)       | i >)        | 73          | 90    | SUB >:                 | z >:        | 90          |
| 74    | LF >*       | j >*        | 74          | 91    | ESC >;                 | { >;        | 91          |
| 75    | VT >+       | k >+        | 75          | 92    | FS ><                  | ><          | 92          |
| 76    | FF >,       | l >,        | 76          | 93    | GS >=                  | } >=        | 93          |
| 77    | CR >-       | m >-        | 77          | 94    | RS >>                  | ~ >>        | 94          |
| 78    | SO >.       | n >.        | 78          | 95    | US >?                  | DEL >?      | 95          |
| 79    | SI >/       | o >/        | 79          | 96    | FNC3 >@                | FNC3 >@     | 96          |
| 80    | DLE >0      | p >0        | 80          | 97    | FNC2 >A                | FNC2 >A     | 97          |
| 81    | DC1 >1      | q >1        | 81          | 98    | SHIFT >B               | SHIFT >B    | 98          |
| 82    | DC2 >2      | r >2        | 82          | 99    | Subset C >C            | Subset C >C | 99          |
| 83    | DC3 >3      | s >3        | 83          | 100   | Subset B >D            | FNC4 >D     | Subset B >D |
| 84    | DC4 >4      | t >4        | 84          | 101   | FNC4 >E                | Subset A >E | Subset A >E |
| 85    | NAK >5      | u >5        | 85          | 102   | FNC1 >F                | FNC1 >F     | FNC1 >F     |
| 86    | SYN >6      | v >6        | 86          | 103   | SUBSET A START CODE >G |             |             |
| 87    | ETB >7      | w >7        | 87          | 104   | SUBSET B START CODE >H |             |             |
| 88    | CAN >8      | x >8        | 88          | 105   | SUBSET C START CODE >I |             |             |

## APPENDIX C. CUSTOM CHARACTERS AND GRAPHICS

### CUSTOM-DESIGNED CHARACTER EXAMPLE

---

The following example is presented to help understand the use of the Custom Designed Characters command. It demonstrates the design and printing of an “arrow” in a 16 x 16 matrix.

1. Determine which matrix size to use
  - 16 dot x 16 dots
  - 24 dots by 24 dots
  
2. Lay out a grid and draw the image on the grid.
  - Each square represents one dot
  - Blacken squares for each printed dot

|   | 1 | 2 | 3 | 4 | 5 | 6 | 7 | 8 | 1 | 2 | 3 | 4 | 5 | 6 | 7 | 8 |
|---|---|---|---|---|---|---|---|---|---|---|---|---|---|---|---|---|
| 1 |   |   |   |   |   |   |   |   |   |   |   |   |   |   |   |   |
| 2 |   |   |   |   |   |   |   |   |   |   |   |   |   |   |   |   |
| 3 |   |   |   |   |   |   |   |   |   |   |   |   |   |   |   |   |
| 4 |   |   |   |   |   |   |   |   |   |   |   |   |   |   |   |   |
| 5 |   |   |   |   |   |   |   |   |   |   |   |   |   |   |   |   |
| 6 |   |   |   |   |   |   |   |   |   |   |   |   |   |   |   |   |
| 7 |   |   |   |   |   |   |   |   |   |   |   |   |   |   |   |   |
| 8 |   |   |   |   |   |   |   |   |   |   |   |   |   |   |   |   |
| 1 |   |   |   |   |   |   |   |   |   |   |   |   |   |   |   |   |
| 2 |   |   |   |   |   |   |   |   |   |   |   |   |   |   |   |   |
| 3 |   |   |   |   |   |   |   |   |   |   |   |   |   |   |   |   |
| 4 |   |   |   |   |   |   |   |   |   |   |   |   |   |   |   |   |
| 5 |   |   |   |   |   |   |   |   |   |   |   |   |   |   |   |   |
| 6 |   |   |   |   |   |   |   |   |   |   |   |   |   |   |   |   |
| 7 |   |   |   |   |   |   |   |   |   |   |   |   |   |   |   |   |
| 8 |   |   |   |   |   |   |   |   |   |   |   |   |   |   |   |   |

- Transfer the image into two bit map representations and then into hexadecimal or binary format.

| ROW | BIT MAP |      |      |      | HEX   |
|-----|---------|------|------|------|-------|
| 1   | 0000    | 0001 | 0000 | 0000 | 01 00 |
| 2   | 0000    | 0011 | 1000 | 0000 | 03 80 |
| 3   | 0000    | 0111 | 1100 | 0000 | 07 C0 |
| 4   | 0000    | 1111 | 1110 | 0000 | 0F E0 |
| 5   | 0001    | 1111 | 1111 | 0000 | 1F F0 |
| 6   | 0011    | 1111 | 1111 | 1000 | 3F F8 |
| 7   | 0111    | 1111 | 1111 | 1100 | 7F FC |
| 8   | 1111    | 1111 | 1111 | 1110 | FF FE |
| 9   | 0000    | 0111 | 1100 | 0000 | 07 C0 |
| 10  | 0000    | 0111 | 1100 | 0000 | 07 C0 |
| 11  | 0000    | 0111 | 1100 | 0000 | 07 C0 |
| 12  | 0000    | 0111 | 1100 | 0000 | 07 C0 |
| 13  | 0000    | 0111 | 1100 | 0000 | 07 C0 |
| 14  | 0000    | 0111 | 1100 | 0000 | 07 C0 |
| 15  | 0000    | 0111 | 1100 | 0000 | 07 C0 |
| 16  | 0000    | 0111 | 1100 | 0000 | 07 C0 |

- To store the custom designed character in memory using a hexadecimal data stream, the command would be:

```
<ESC>A
<ESC>T1H3F0100038007C00FE01FF03FF87FFCFFFE07C007C007C007C007C007C007C0
<ESC>Z
```

*Note: This should be a continuous data string without any CR or LF characters.*

- To recall the custom character from memory, send the following code to the printer. Note that you can print other data as well. Also note how the character size was expanded using the <ESC>L command.

```
<ESC>A
<ESC>L0505<ESC>H0150<ESC>V100<ESC>K1H903F
<ESC>L0505<ESC>H0600<ESC>V100<ESC>K1H903F
<ESC>L0303<ESC>H0125<ESC>V0250<ESC>MTHIS SIDE UP !
<ESC>Q1
<ESC>Z
```

- To store the custom designed character in memory using a binary data stream, the command would be:

```
<ESC>A
<ESC>T1B3F 01H 00H 03H 80H 07H C0H 0FH E0H 1FH F0H 3FH F8H 7FH FCH FFH FEH
07H C0H 07H C0H 07H C0H 07H C0H 07H C0H 07H C0H 07H C0H 07H C0H
<ESC>Z
```

NOTE: Spaces are shown between hexadecimal values in the above example for clarity only and are *not* included in the data string.

*Note that the data stream is only half as long as the hexadecimal format. This is because we can send the binary equivalent of “11111111” (represented above in its hexadecimal value of FF<sub>H</sub>), for example, using one eight bit word while it takes two eight bit words to transmit the hexadecimal equivalent “F” and “F”. To send binary characters using BASIC, the expression “CHR (&HFF) will send the binary equivalent of FF (i.e., 11111111).*

6. To recall the custom character from memory, send the following code to the printer:

```
<ESC>A
<ESC>L505<ESC>H0150<ESC>V100<ESC>K1B903F
<ESC>L505<ESC>H0600<ESC>V100<ESC>K1B903F
<ESC>L0303<ESC>H0125<ESC>V0250<ESC>XMTHIS SIDE UP !
<ESC>Q1
<ESC>Z
```

The printer output for both the hexadecimal and binary format examples is:

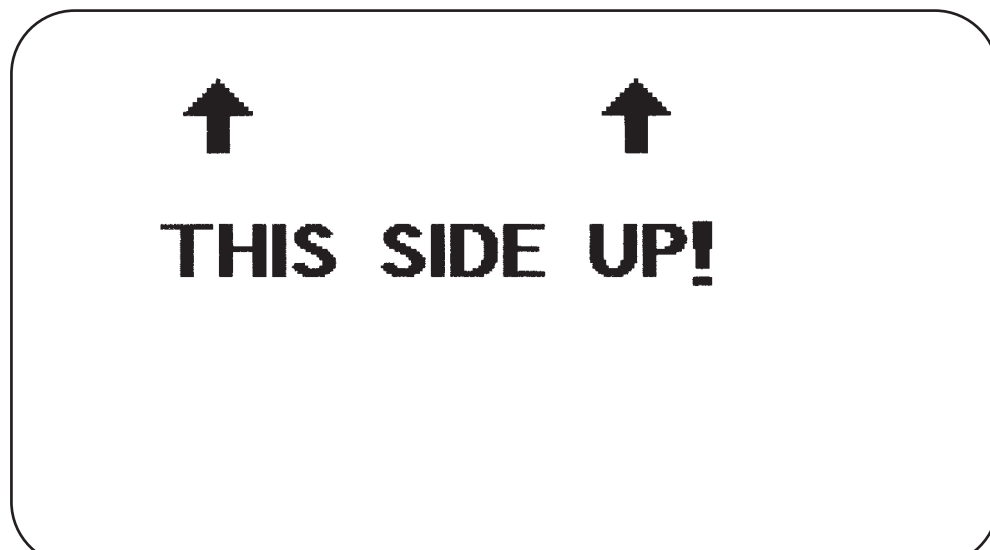

## CUSTOM GRAPHICS EXAMPLE

The following example is presented to help you understand the use of the Custom Graphics command. It demonstrates the design and printing of a “diskette” in a 48 x 48 matrix.

1. Determine the matrix size for the graphic. It must be in 8 dot by 8 dot blocks. The example here has six blocks horizontally and six blocks vertically (48 x 48).
2. Lay out a grid and draw the image on the grid.
  - Each square represents one dot
  - Blacken squares for each printed dot

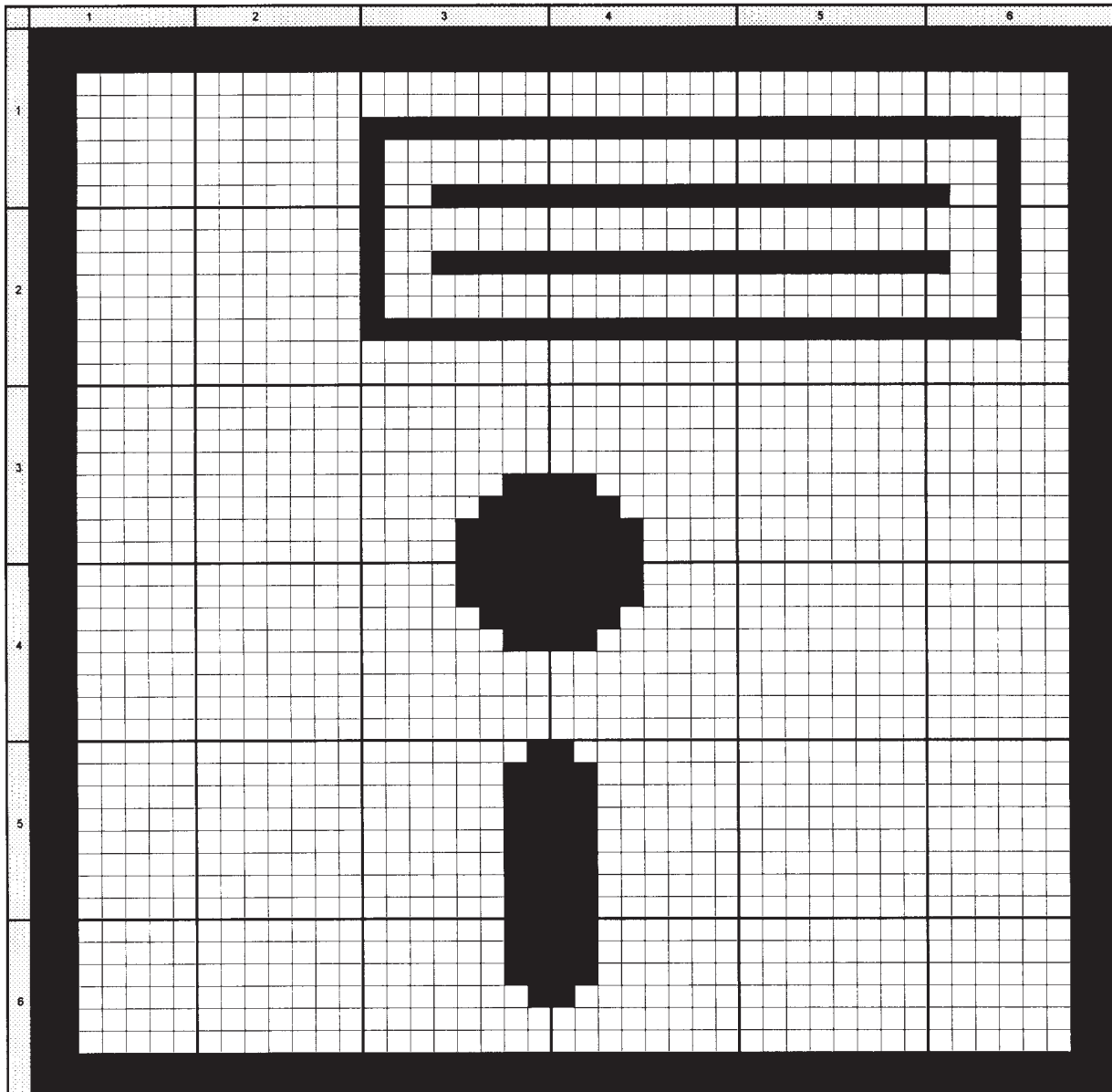

3. Transfer the image into a bit map representation and then into hexadecimal format:

| BIT MAP  |          |          |          |          |          | HEXADECIMAL FORMAT |    |    |    |    |    |
|----------|----------|----------|----------|----------|----------|--------------------|----|----|----|----|----|
| 1        | 2        | 3        | 4        | 5        | 6        | 1                  | 2  | 3  | 4  | 5  | 6  |
| 11111111 | 11111111 | 11111111 | 11111111 | 11111111 | 11111111 | FF                 | FF | FF | FF | FF | FF |
| 11111111 | 11111111 | 11111111 | 11111111 | 11111111 | 11111111 | FF                 | FF | FF | FF | FF | FF |
| 11000000 | 00000000 | 00000000 | 00000000 | 00000000 | 00000011 | C0                 | 00 | 00 | 00 | 00 | 03 |
| 11000000 | 00000000 | 00000000 | 00000000 | 00000000 | 00000011 | C0                 | 00 | 00 | 00 | 00 | 03 |
| 11000000 | 00000000 | 11111111 | 11111111 | 11111111 | 11110011 | C0                 | 00 | FF | FF | FF | 03 |
| 11000000 | 00000000 | 10000000 | 00000000 | 00000000 | 00010011 | C0                 | 00 | 80 | 00 | 00 | 13 |
| 11000000 | 00000000 | 10000000 | 00000000 | 00000000 | 00010011 | C0                 | 00 | 80 | 00 | 00 | 13 |
| 11000000 | 00000000 | 10011111 | 11111111 | 11111111 | 00010011 | C0                 | 00 | 9F | FF | FF | 13 |
| 11000000 | 00000000 | 10000000 | 00000000 | 00000000 | 00010011 | C0                 | 00 | 80 | 00 | 00 | 13 |
| 11000000 | 00000000 | 10000000 | 00000000 | 00000000 | 00010011 | C0                 | 00 | 80 | 00 | 00 | 03 |
| 11000000 | 00000000 | 10011111 | 11111111 | 11111111 | 00010011 | C0                 | 00 | 9F | FF | FF | 13 |
| 11000000 | 00000000 | 10000000 | 00000000 | 00000000 | 00010011 | C0                 | 00 | 80 | 00 | 00 | 13 |
| 11000000 | 00000000 | 10000000 | 00000000 | 00000000 | 00010011 | C0                 | 00 | 80 | 00 | 00 | 13 |
| 11000000 | 00000000 | 11111111 | 11111111 | 11111111 | 11110011 | C0                 | 00 | FF | FF | FF | F3 |
| 11000000 | 00000000 | 00000000 | 00000000 | 00000000 | 00000011 | C0                 | 00 | 00 | 00 | 00 | 03 |
| 11000000 | 00000000 | 00000000 | 00000000 | 00000000 | 00000011 | C0                 | 00 | 00 | 00 | 00 | 03 |
| 11000000 | 00000000 | 00000000 | 00000000 | 00000000 | 00000011 | C0                 | 00 | 00 | 00 | 00 | 13 |
| 11000000 | 00000000 | 00000000 | 00000000 | 00000000 | 00000011 | C0                 | 00 | 00 | 00 | 00 | 13 |
| 11000000 | 00000000 | 00000011 | 11000000 | 00000000 | 00000011 | C0                 | 00 | 03 | C0 | 00 | 03 |
| 11000000 | 00000000 | 00000111 | 11100000 | 00000000 | 00000011 | C0                 | 00 | 07 | E0 | 00 | 03 |
| 11000000 | 00000000 | 00001111 | 11110000 | 00000000 | 00000011 | C0                 | 00 | 0F | F0 | 00 | 03 |
| 11000000 | 00000000 | 00001111 | 11110000 | 00000000 | 00000011 | C0                 | 00 | 0F | F0 | 00 | 03 |
| 11000000 | 00000000 | 00001111 | 11110000 | 00000000 | 00000011 | C0                 | 00 | 07 | E0 | 00 | 03 |
| 11000000 | 00000000 | 00000011 | 11000000 | 00000000 | 00000011 | C0                 | 00 | 03 | C0 | 00 | 03 |
| 11000000 | 00000000 | 00000000 | 00000000 | 00000000 | 00000011 | C0                 | 00 | 00 | 00 | 00 | 03 |
| 11000000 | 00000000 | 00000000 | 00000000 | 00000000 | 00000011 | C0                 | 00 | 00 | 00 | 00 | 03 |
| 11000000 | 00000000 | 00000000 | 00000000 | 00000000 | 00000011 | C0                 | 00 | 00 | 00 | 00 | 03 |
| 11000000 | 00000000 | 00000000 | 00000000 | 00000000 | 00000011 | C0                 | 00 | 00 | 00 | 00 | 03 |
| 11000000 | 00000000 | 00000000 | 00000000 | 00000000 | 00000011 | C0                 | 00 | 00 | 00 | 00 | 03 |
| 11000000 | 00000000 | 00000001 | 10000000 | 00000000 | 00000011 | C0                 | 00 | 01 | 80 | 00 | 03 |
| 11000000 | 00000000 | 00000011 | 11000000 | 00000000 | 00000011 | C0                 | 00 | 03 | C0 | 00 | 03 |
| 11000000 | 00000000 | 00000011 | 11000000 | 00000000 | 00000011 | C0                 | 00 | 03 | C0 | 00 | 03 |
| 11000000 | 00000000 | 00000011 | 11000000 | 00000000 | 00000011 | C0                 | 00 | 03 | C0 | 00 | 03 |
| 11000000 | 00000000 | 00000011 | 11000000 | 00000000 | 00000011 | C0                 | 00 | 03 | C0 | 00 | 03 |
| 11000000 | 00000000 | 00000011 | 11000000 | 00000000 | 00000011 | C0                 | 00 | 03 | C0 | 00 | 03 |
| 11000000 | 00000000 | 00000011 | 11000000 | 00000000 | 00000011 | C0                 | 00 | 03 | C0 | 00 | 03 |
| 11000000 | 00000000 | 00000011 | 11000000 | 00000000 | 00000011 | C0                 | 00 | 03 | C0 | 00 | 03 |
| 11000000 | 00000000 | 00000001 | 10000000 | 00000000 | 00000011 | C0                 | 00 | 01 | 80 | 00 | 03 |
| 11000000 | 00000000 | 00000000 | 00000000 | 00000000 | 00000011 | C0                 | 00 | 03 | C0 | 00 | 03 |
| 11000000 | 00000000 | 00000000 | 00000000 | 00000000 | 00000011 | C0                 | 00 | 03 | C0 | 00 | 03 |
| 11000000 | 00000000 | 00000000 | 00000000 | 00000000 | 00000011 | C0                 | 00 | 03 | C0 | 00 | 03 |
| 11000000 | 00000000 | 00000000 | 00000000 | 00000000 | 00000011 | C0                 | 00 | 03 | C0 | 00 | 03 |
| 11000000 | 00000000 | 00000000 | 00000000 | 00000000 | 00000011 | C0                 | 00 | 03 | C0 | 00 | 03 |
| 11111111 | 11111111 | 11111111 | 11111111 | 11111111 | 11111111 | FF                 | FF | FF | FF | FF | FF |
| 11111111 | 11111111 | 11111111 | 11111111 | 11111111 | 11111111 | FF                 | FF | FF | FF | FF | FF |

- Using the hexadecimal data, send the following code to print the graphic image as designed.

```
<ESC>A<ESC>H0100<ESC>V0100<ESC>GH006006
FFFFFF FFFFFFF FFFFFFF FFFFFFF C00000 000003
C00000 000003 C000FF FFFF33 C00080 000013
C00080 000013 C0009F FFFF13 C00080 000013
C00080 000013 C0009F FFFF13 C00080 000013
C00080 000013 C000FF FFFF33 C00000 000003
C00000 000003 C00000 000003 C00000 000003
C00000 000003 C00000 000003 C00003 C00003
C00007 E00003 C0000F F00003 C0000F F00003
C0000F F00003 C0000F F00003 C00007 E00003
C00003 C00003 C00000 000003 C00000 000003
C00000 000003 C00000 000003 C00001 800003
C00003 C00003 C00003 C00003 C00003 C00003
C00003 C00003 C00003 C00003 C00003 C00003
C00003 C00003 C00003 C00003 C00003 C00003
C00003 C00003 C00001 800003 C00000 000003
C00000 000003 FFFFFFF FFFFFFF FFFFFFF FFFFFFF
<ESC>Q1<ESC>Z
```

*Note: Spaces shown in the hexadecimal listing above are for emphasis only. Spaces must not be encoded within the graphic portion of the data stream to the printer. Also, CR and LF characters to separate the lines must not be encoded in the data stream.*

- To send the data in binary format, the software must convert the data into binary format before transmitting it to the printer. Using the BASIC programming language for example, this is done by notation “CHR\$ (&HC0)” which sends the hexadecimal value of “C0” as binary data (11000000). The BASIC program listing for sending this graphic to the printer (using the RS232 port) in binary format is:

```
CLS
OPEN "COM2:9600,N,8,1,CS,DS" FOR OUTPUT AS #1
E$ = CHR$(27)
PRINT #1,CHR$(2); E$; "A"; E$; "V0100"; E$; "H0100"; E$; "GB006006";
PRINT #1,CHR$(&HFF);CHR$(&HFF);CHR$(&HFF);CHR$(&HFF);CHR$(&HFF);
PRINT #1,CHR$(&HFF);CHR$(&HFF);CHR$(&HFF);CHR$(&HFF);CHR$(&HFF);
PRINT #1,CHR$(&HFF);CHR$(&HFF);CHR$(&HC0);CHR$(&H00);CHR$(&H00);
PRINT #1,CHR$(&H00);CHR$(&H00);CHR$(&H03);CHR$(&HC0);CHR$(&H00);
PRINT #1,CHR$(&H00);CHR$(&H00);CHR$(&H00);CHR$(&H03);CHR$(&HC0);
PRINT #1,CHR$(&H00);CHR$(&HFF);CHR$(&HFF);CHR$(&HFF);CHR$(&HF3);
PRINT #1,CHR$(&HC0);CHR$(&H00);CHR$(&H80);CHR$(&H00);CHR$(&H00);
PRINT #1,CHR$(&H13);CHR$(&HC0);CHR$(&H00);CHR$(&H80);CHR$(&H00);
PRINT #1,CHR$(&H00);CHR$(&H13);CHR$(&HC0);CHR$(&H00);CHR$(&H9F);
PRINT #1,CHR$(&HFF);CHR$(&HFF);CHR$(&H13);CHR$(&HC0);CHR$(&H00);
PRINT #1,CHR$(&H80);CHR$(&H00);CHR$(&H00);CHR$(&H13);CHR$(&HC0);
PRINT #1,CHR$(&H00);CHR$(&H80);CHR$(&H00);CHR$(&H00);CHR$(&H13);
PRINT #1,CHR$(&HC0);CHR$(&H00);CHR$(&H9F);CHR$(&HFF);CHR$(&HFF);
PRINT #1,CHR$(&H13);CHR$(&HC0);CHR$(&H00);CHR$(&H80);CHR$(&H00);
PRINT #1,CHR$(&H00);CHR$(&H13);CHR$(&HC0);CHR$(&H00);CHR$(&H80);
PRINT #1,CHR$(&H00);CHR$(&H00);CHR$(&H13);CHR$(&HC0);CHR$(&H00);
PRINT #1,CHR$(&HFF);CHR$(&HFF);CHR$(&HFF);CHR$(&HF3);CHR$(&HC0);
PRINT #1,CHR$(&H00);CHR$(&H00);CHR$(&H00);CHR$(&H00);CHR$(&H03);
PRINT #1,CHR$(&HC0);CHR$(&H00);CHR$(&H00);CHR$(&H00);CHR$(&H00);
PRINT #1,CHR$(&H03);CHR$(&HC0);CHR$(&H00);CHR$(&H00);CHR$(&H00);
PRINT #1,CHR$(&H00);CHR$(&H03);CHR$(&HC0);CHR$(&H00);CHR$(&H00);
PRINT #1,CHR$(&H00);CHR$(&H00);CHR$(&H03);CHR$(&HC0);CHR$(&H00);
PRINT #1,CHR$(&H00);CHR$(&H00);CHR$(&H00);CHR$(&H03);CHR$(&HC0);
```

```

PRINT #1,CHR$(&H00);CHR$(&H00);CHR$(&H00);CHR$(&H00);CHR$(&H03);
PRINT #1,CHR$(&HC0);CHR$(&H00);CHR$(&H03);CHR$(&HC0);CHR$(&H00);
PRINT #1,CHR$(&H03);CHR$(&HC0);CHR$(&H00);CHR$(&H07);CHR$(&H00);
PRINT #1,CHR$(&H00);CHR$(&H03);CHR$(&HC0);CHR$(&H00);CHR$(&H0F);
PRINT #1,CHR$(&HF0);CHR$(&H00);CHR$(&H03);CHR$(&HC0);CHR$(&H00);
PRINT #1,CHR$(&H0F);CHR$(&HF0);CHR$(&H00);CHR$(&H03);CHR$(&HC0);
PRINT #1,CHR$(&H00);CHR$(&H0F);CHR$(&HF0);CHR$(&H00);CHR$(&H03);
PRINT #1,CHR$(&HC0);CHR$(&H00);CHR$(&H0F);CHR$(&HF0);CHR$(&H00);
PRINT #1,CHR$(&H03);CHR$(&HC0);CHR$(&H00);CHR$(&H07);CHR$(&HE0);
PRINT #1,CHR$(&H00);CHR$(&H03);CHR$(&HC0);CHR$(&H00);CHR$(&H03);
PRINT #1,CHR$(&HC0);CHR$(&H00);CHR$(&H03);CHR$(&HC0);CHR$(&H00);
PRINT #1,CHR$(&H00);CHR$(&H00);CHR$(&H00);CHR$(&H03);CHR$(&HC0);
PRINT #1,CHR$(&H00);CHR$(&H00);CHR$(&H00);CHR$(&H00);CHR$(&H00);
PRINT #1,CHR$(&H03);CHR$(&HC0);CHR$(&H00);CHR$(&H00);CHR$(&H00);
PRINT #1,CHR$(&H00);CHR$(&H03);CHR$(&HC0);CHR$(&H00);CHR$(&H01);
PRINT #1,CHR$(&H80);CHR$(&H00);CHR$(&H03);CHR$(&HC0);CHR$(&H00);
PRINT #1,CHR$(&H03);CHR$(&HC0);CHR$(&H00);CHR$(&H03);CHR$(&HC0);
PRINT #1,CHR$(&H00);CHR$(&H03);CHR$(&HC0);CHR$(&H00);CHR$(&H03);
PRINT #1,CHR$(&HC0);CHR$(&H00);CHR$(&H03);CHR$(&HC0);CHR$(&H00);
PRINT #1,CHR$(&H03);CHR$(&HC0);CHR$(&H00);CHR$(&H03);CHR$(&HC0);
PRINT #1,CHR$(&H00);CHR$(&H03);CHR$(&HC0);CHR$(&H00);CHR$(&H03);
PRINT #1,CHR$(&HC0);CHR$(&H00);CHR$(&H03);CHR$(&HC0);CHR$(&H00);
PRINT #1,CHR$(&H03);CHR$(&HC0);CHR$(&H00);CHR$(&H03);CHR$(&HC0);
PRINT #1,CHR$(&H00);CHR$(&H03);CHR$(&HC0);CHR$(&H00);CHR$(&H03);
PRINT #1,CHR$(&HC0);CHR$(&H00);CHR$(&H03);CHR$(&HC0);CHR$(&H00);
PRINT #1,CHR$(&H03);CHR$(&HFF);CHR$(&HFF);CHR$(&HFF);CHR$(&HFF);
PRINT #1,CHR$(&HFF);CHR$(&HFF);CHR$(&HFF);CHR$(&HFF);CHR$(&HFF);
PRINT #1,CHR$(&HFF);CHR$(&HFF);CHR$(&HFF);
PRINT #1,E$,"Q1";E$,"Z";CHR$(3)
CLOSE #1

```

The printer output for both the hexadecimal and binary format examples is:



## PCX GRAPHICS EXAMPLE

---

A graphics file in a PCX format may also be transmitted to the printer. The file must not be larger than 32K bytes (DOS file size reported in a DIR listing). For example,



the WIZ.PCX image shown below has a file size of 15076 bytes.

The uncompressed size (PCX is a compressed file) of the file must not be greater than 64K bytes. Generally this is not a problem unless the graphic image is surrounded by large amount of white space which the PCX algorithm can compress very efficiently. If this is the case, the file should be recaptured to eliminate the surrounding white space as much as possible.

The following basic program will send and print this file:

```
OPEN "WIZ.PCX" FOR INPUT AS #2
DA$ = INPUT$(15706, #2)
C$ = CHR$(27)
WIDTH "LPT1:", 255
LPRINT C$; "A";
LPRINT C$; "V150"; C$; "H100"; C$; "GP15706"; DA$
LPRINT C$; "Q1"; C$; "Z";
CLOSE #2
```

The printer output for this program is:



## APPENDIX D. OPTIONAL ACCESSORIES

---

This section contains instructions for using the following features:

- PCMCIA Memory Cards
- Calendar Option
- Top Mounted Reflective Sensor

### PCMCIA MEMORY CARDS

---

#### Description

The Memory Card Option provides the connectors and interface board for two PCMCIA memory cards slots. The printer memory can be expanded up to 4MB.

|                           |                                         |
|---------------------------|-----------------------------------------|
| Type                      | RAM or Flash-ROM                        |
| Applicable Specifications | PCMCIA Version 2.1 (JEIDA Version 4.1)  |
| Size                      | 128KB, 256KB, 512KB, 1MB or 2MB         |
| Connector Pins            | 68                                      |
| Battery                   | Two years for SCAM type (approximately) |
| Write Protect             | Yes                                     |
| Low Battery Detect        | Yes                                     |

#### Installation

Instructions for installing the Memory Card Option are included with the installation kit.

#### Error Handling

Memory Card error conditions are indicated to the operator using a combination of the ERROR LED on the front panel and the audible indicator.

| ERROR DESCRIPTION                                                                                                                                | INDICATION                                                                                                                      | REMEDY                                                                                                                          |
|--------------------------------------------------------------------------------------------------------------------------------------------------|---------------------------------------------------------------------------------------------------------------------------------|---------------------------------------------------------------------------------------------------------------------------------|
| Low Battery - Low battery condition is detected when printer is powered on.                                                                      | ERROR LED:   Blinking<br>Audible Beep:  1 long<br>Display:       Card Low Battery<br><br>Depress LINE key to print Card Status. | Replace Memory Card battery. Note that all data will be lost when the battery is removed.                                       |
| Card R/W Error<br>1. No card is inserted.<br>2. Card is write protected.<br>3. Invalid store/recall number.<br>4. Card has not been initialized. | ERROR LED:   On<br>Audible Beep:  1 long<br>Display:       Card R/W Error<br><br>Printer must be powered off to reset.          | 1. Insert card into selected slot.<br>2. Remove write protect tab.<br>3. Correct program<br>4. Initialize card with BJT command |
| Warning<br>1. Duplicate number.<br>2. Data not in print area.<br>3. Data overflows card memory.                                                  | Audible Beep:  1 short<br>Display:       None<br><br>Printer will ignore invalid commands.                                      | 1. Correct program.<br>2. Correct program.<br>3. Use card with more capacity.                                                   |

## CALENDAR

---

The Calendar Option allows the date and time to be maintained in the local printer rather than using the system clock. It consists of a daughter PCBA containing a clock IC, a lithium battery and a EEPROM. This assembly replaces the EEPROM in the standard printer. A qualified technician should perform the upgrade as it requires modifications to the main PCB assembly. Please call SATO Technical Support if you need to add this option to an existing printer in the field.

## **TOP MOUNTED REFLECTIVE SENSOR**

---

If there is a requirement for printing a registration mark on the top of a label instead of on the bottom side, a Top Mounted Reflective Sensor Assembly can be installed. This option is not available on the M-8460S and the Left-Hand version of the M-8485S.

## APPENDIX E. CUSTOM PROTOCOL COMMAND CODES

### DESCRIPTION

This section contains information on creating custom Protocol Command Codes for operating the “S” printers. The Protocol Command codes are used to tell the printer that a specific type of information is being transmitted to it. As an example, the Standard Protocol Command Code specifies the use of an <ESC> character to tell the printer that the following character(s) will represent a specific command. Sometimes the host computer is unable to generate the character or it uses the <ESC> character to control another function. In this case, an Alternate Protocol Command Code set can be selected for use by placing DIP switch 2-7 in the ON position. When the Alternate set is selected, the <ESC> character is not used and is instead replaced with a “carrot” (^) character. A command stream would then start with an “^” instead of an “<ESC>”. These two sets of Protocol Command Codes are adequate for the majority of all applications, but occasionally situations occur where conflicts exist when using the Alternate set. In these cases, the user can define and download a custom set of Protocol Command Codes that are stored in EEPROM memory in the printer. After these are downloaded, they replace the Alternate Command Code set when DIP switch DS2-7 is in the ON position. When DIP switch DS2-7 is in the OFF position, the Standard Protocol Command Codes are used.

### DOWNLOAD COMMAND STRUCTURE

The command for downloading a new set of Protocol Command Codes takes the form of “<ESC>LD,a,b,c,d,e,f,g,h,i”. The parameters specified for “a” through “i” can be transmitted in either ASCII characters or hex notation, allowing a complete 128 character (except for the “,”) set to be used for selecting the custom code.

| PARAMETER       | STANDARD SETTING | ALTERNATE SETTING (DEFAULT) |
|-----------------|------------------|-----------------------------|
| a               | STX              | {                           |
| b               | ETX              | }                           |
| c               | ESC              | ^                           |
| d               | ENQ              | @                           |
| e               | CAN              | !                           |
| g               | OFFLINE          | ]                           |
| h (Auto ONLINE) | No               | 0 = YES<br>1 = NO           |
| i (Zero Slash)  | No               | 0 = YES<br>1 = NO           |

## RESET

---

If the custom Protocol Command codes are incorrect or if the printer does not respond to commands using the custom set, the Alternate Protocol Control Codes can be restored by the following procedure:

1. Turn the printer off.
2. Place DIP switch **DS2-7** in the **ON** position.
3. Turn power on while simultaneously pressing the **FEED** and **LINE** switches.
4. When the message “ALT PROTOCOL DEFAULT COMPLETED” appears on the display, turn the printer off.



ALT PROTOCOL  
DEFAULT COMPLETE

5. When the printer is powered up again, the Alternate Protocol Command Code set will be active. All previous custom settings will be lost.

## DOWNLOAD PROCEDURE

---

The procedure for downloading a custom Protocol Command Code set is:

1. Reset the printer to the default settings using the Reset procedure.
2. Place DIP switch **DS2-7** in the **ON** position.
3. Turn the POWER switch ON while simultaneously pressing the **LINE** switch. This places the printer in the USER DOWNLOAD mode.



USER DOWNLOAD

4. Set DIP switch **DS2-7** in the position to accept the Protocol Control codes to be used for downloading (i.e. DS2-7 = OFF for Standard codes and DS2-7 ON to use the Alternate set).
5. Press the **LINE** key to place the M-8485S in the ON-LINE mode. The LINE LED should be on and the printer is ready to receive the download command data stream.
6. After the command has been sent, the unit will beep and print a status label. If it does not beep and print the label, the printer did not accept the data.
7. If the printer does not beep and print a setting label, turn the printer off, check your download command stream for errors and start the download process over at step 1.

8. If the custom codes are correct, press the FEED key to accept them and terminate the download process. If they are incorrect, turn the unit off without pressing the FEED key and begin the download process again at step 1.

STX = XX  
ETX=XX  
ESC=XX  
ENQ=XX  
CAN=XX  
NULL=XX  
AUTO ONLINE=YES  
ZERO SLASH=YES