

Packaging - Processing

Bid on Equipment

1-847-683-7720

www.bid-on-equipment.com

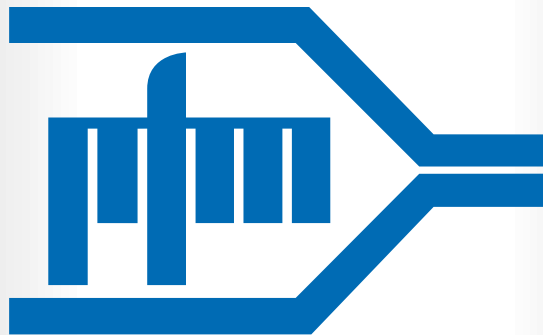

Packaging Machinery



Scirocco

Scirocco

Packaging - Processing
Bid on Equipment
1-847-683-7720
www.bid-on-equipment.com



Product examples.

The **Scirocco** is a Flow Pack Servo Assisted horizontal wrapping machine for producing wraps hermetically sealed on three sides from a reel of heatseal wrapping material. The machine has been designed for Modified Atmosphere Packaging and constructed in such a way that all its parts can be cleaned.

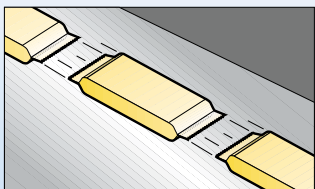

Hermetic sealing at high wrapping speeds: thanks to the Long Dwell (PFM patented) and Long Dwell HS "multi-crimper" sealing systems, the Scirocco easily achieves wrapping speeds of 140 to 400 packs per minute. Furthermore, the PB sealing system (PFM patented) allows the creation of Pocket Bag wraps.

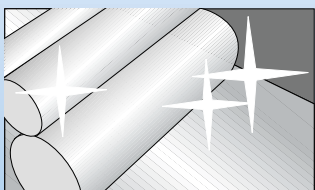

Easy cleaning: the structure in AISI 304 with large radius corners, the cantilevered structure and the possibility of quickly releasing the belt that joins the forming tunnel and the Long Dwell unit ensure that all parts of the machine, both visible and hidden, can be cleaned.

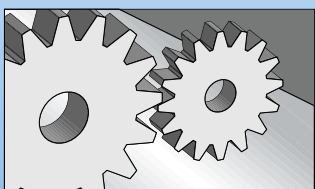

Cantilevered construction: the mechanical and electronic components are housed at the back of the wrapping machine in a separate, protected environment. The front of the machine is left free. Production residues can therefore fall freely to the floor, thus assisting cleaning of the machine.

Servo version:

A new PFM User Friendly automatic programming facility which can easily set up all the machine's functions for up to 60 separate programmes via a touch screen control panel. Format changes are recalled automatically, in particular:

- Adjustment of product length.
- Adjustment of deceleration.
- The various product stages.
- Adjustment of print centring.
- Adjustment of alignment of the printing equipment.

Over and above this, special functions are included such as "no product, no bag" and automatic height adjustment of the transverse sealing jaws.

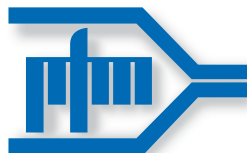

Packaging Machinery

Main standard functions:

- Servo machine equipped with 3 brushless motors with electronic control.
- Double expanding reel holding shaft with reel diameter up to 600 mm.
- Reel disc brake.
- Rapid release of the forming box-Long Dwell unit connecting belt.
- Motorized system for adjusting the height of the Long Dwell unit.
- 3 pairs of tiltable wheels for longitudinal sealing.
- Infeed conveyor with interchangeable product pushers.



Flow pack-vacuum system.

The Scirocco and vacuum bell represent the economical, straightforward, flexible and highly productive combination for creating vacuum-packed wraps from a reel of film, even printed.



Main Options:

- Date / Bar Code printing equipment.
- Automatic reel Splicer.
- Longitudinal crimpers with slat conveyor and trimming device with retrieval of excess trim for a smooth, uniform seal.
- Modified Atmosphere Packaging application.

Models available:

- Long Dwell version.
- Long Dwell version HS with two crimpers per shaft
- Pocket Bag version

Packaging - Processing
Bid on Equipment
1-847-683-7720
www.bid-on-equipment.com

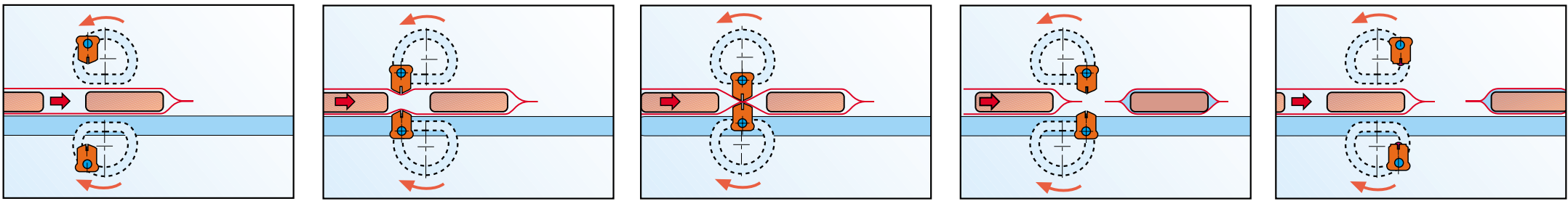

Long Dwell sealing system (PFM patented) with one crimper per shaft for medium-sized/large products and high operating flexibility. Up to 140 cycles/min.

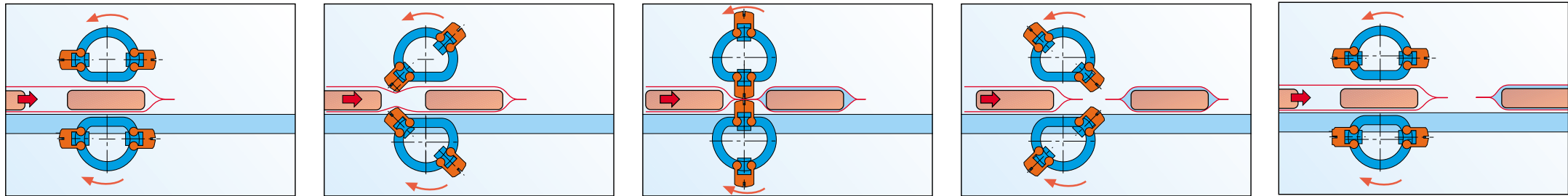

Long Dwell HS/2 system with two crimpers per shaft for medium-sized/small products for a maximum speed of 200 cycles/min.

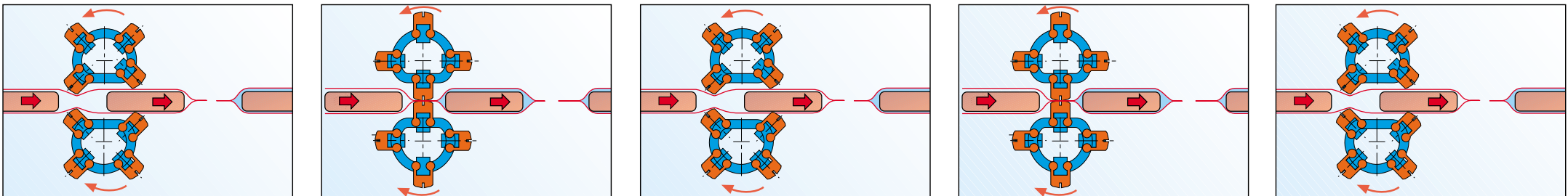

Long Dwell HS/4 system with four crimpers per shaft for small products for a maximum speed of 400 cycles/min. Besides that, a "Stand-up crimpers" system for producing Pocket Bag wraps is available.

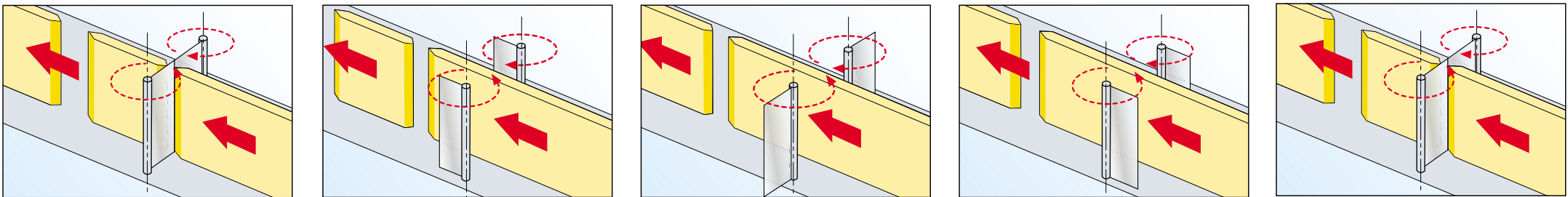

'Standing crimpers' system.



Long Dwell sealing system:

Temperature, Pressure and Time are the three principle factors that when optimized, using appropriate wrapping material, enables high Integrity / Hermetic sealing to be achieved. The PFM Long Dwell and Long Dwell HS sealing systems with equal temperature and pressure allow for a longer sealing time than the traditional rotary system. By taking advantage of the Time / Pressure element, Hermetic Sealing and high speed wrapping is, therefore, possible.

Examples of wrappable products.



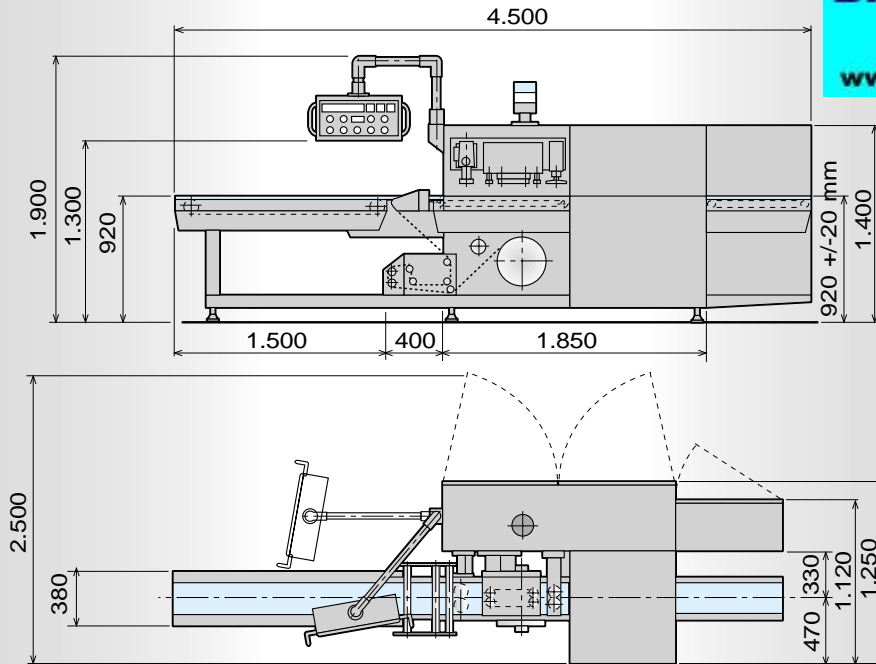

Scirocco

Technical Data:

Pack length:	min 10, max 350 mm*
Pack width:	min 10, max 320 mm*
Pack height:	max 110 mm*
Reel width:	max 700 mm
Reel diameter:	max 600 mm
Crimper width:	max 350 mm*
Mechanical speed:	140 cycles/min LD version - 400 cycles/min LDHS 4 crimpers version
Sealing unit:	Long Dwell (pat. PFM), Long Dwell HS/2 e HS/4
Available versions:	BB, LDHS, BDF
Power supply:	380 Volt 3 phase + neutral + earth
Weight:	1100 kg
Power consumption:	7 kw
Type of infeed:	In line (AFL ATL), ECF90°

* Depending on sealing unit: LD or LDHS type

PFM reserves the right to modify technical data without previous notice.

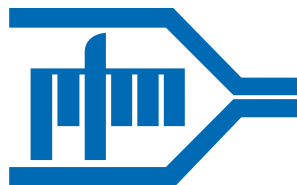

Packaging Machinery

**PFM S.p.A. SEDE CENTRALE
PACKAGING MACHINERY**

ITALIA
Via Pasubio, 49 -
Torrebelvicino (VI) ITALIA

Tel: 0445/570110
Fax: 0445/570175
Telex: 480405
Internet: www.pfm.it
E-mail: pfm@pfm.it

**PFM PACKAGING
MACHINERY LTD**

GREAT BRITAIN
Unit 8/9, Intercity Way
LEEDS LS13 - 4LY

Tel: (+44) -113 -2393401
Fax: (+44) -113 -2393402
E-mail: pfm@pfm-ltd.co.uk

**PFM PACKAGING
MACHINERY
CORPORATION
USA & CANADA**

1271, Ringwell Ave.
Newmarket
Ont. Canada L3Y 7V1.

Tel: (+1) - 905 - 836 - 6709
Fax: (+1) - 905 - 836 - 7763
Internet: www.pfmusa.com
E-mail: info@pfmusa.com

**PFM PACKAGING
MACHINERY LTD**

RUSSIA
UL. BOLSCIAIA NIKITSKAYA,
31, kv.9
103009 MOSCOW

Tel - Fax: (007) (095) 9265086