

# Packaging Machinery



# Mistral

---

Packaging - Processing  
**Bid on Equipment**  
1-847-683-7720  
[www.bid-on-equipment.com](http://www.bid-on-equipment.com)

# Mistral

Packaging - Processing  
**Bid on Equipment**  
1-847-683-7720  
[www.bid-on-equipment.com](http://www.bid-on-equipment.com)



Product examples.

The **Mistral** is a horizontal flow-pack wrapping machine which produces at high speed hermetically closed seals from a flat reel of heat sensitive wrapping material. The Mistral is specifically designed to be compatible with "M.A.P." (Modified Atmosphere Packaging) wrapping. The main features which make the Mistral a world landmark in the field of packaging are as follows:

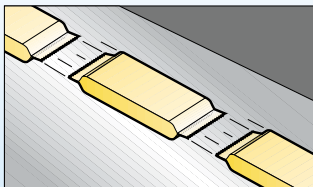

**High speed wrapping:** High speed wrapping with Hermetic Seals: thanks to the long dwell, continuous flow, transverse sealing system, the Mistral reaches packaging speed of up to 140 packs per minute with the Long Dwell version (pat. PFM) and 400 packs per minute with the Long Dwell HS version.

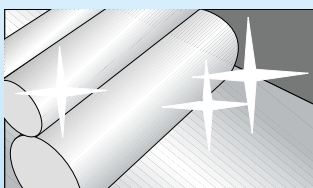

**Ease of cleaning:** the Mistral has a cantilever type construction. This means the various mechanical and electronic parts are situated at the rear of the machine in separate and protected compartments, whereas the product conveyor belts and sealing area are found at the front. As a result, the front of the machine is obstruction-free and allows any product residue to be cleaned easily without it ever coming into contact with the mechanical or electronic workings.

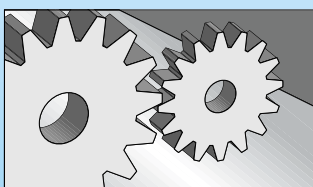

**Superior quality of parts and meticulous mechanical engineering:** The Mistral, with its ease of operation, minimum maintenance and quality of component parts / raw materials used, are the factors which guarantee, in principle, a limitless lifespan.

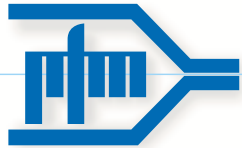

## Packaging Machinery



The Mistral with reel feed from above.

### Main standard functions:

The machine is manufactured with the following standard features:

- A 2-metre Infeed Conveyor Belt with Adjustable Approach Rollers.
- An Adjustable Forming Box to facilitate easily the formatting of length and width adjustments in different packages.
- Double self-centring Reel Holder complete with Brake.
- Photocell for print registered packaging material centring.
- Balancing device for controlling the tension of the film.
- Deceleration system and self-lubricating drive.
- Powered Height adjustment on crimper Head assembly with motor.

### Main Options:

- Date / Bar Code printing equipment.
- Automatic reel Splicer.
- Longitudinal crimpers with slat conveyor and trimming device with retrieval of excess trim for a smooth, uniform seal.
- Modified Atmosphere Packaging application.

### Models available:

- With reel feed from above (Conventional).
- With reel feed from below (Inverted).
- Electronic version.
- Servo version.
- Long Dwell HS version.
- Polyethylene version.
- BDF version **(for use with wrapping materials where high barrier properties are required).**



### Servo version:

A new PFM User Friendly automatic programming facility which can easily set up all the machine's functions for up to 60 separate programmes via a touch screen control panel. Format changes are recalled automatically, in particular:

- Adjustment of product length.
- Adjustment of deceleration.
- The various product stages.
- Adjustment of print centring.
- Adjustment of alignment of the printing equipment.

Over and above this, special functions are included such as "no product, no bag" and automatic height adjustment of the transverse sealing jaws.



The Mistral with reel feed from below.

**Packaging - Processing**  
**Bid on Equipment**  
 1-847-683-7720  
[www.bid-on-equipment.com](http://www.bid-on-equipment.com)

## Long Dwell sealing system:

Temperature, Pressure and Time are the three principle factors that when optimized, using appropriate wrapping material, enables high Integrity / Hermetic sealing to be achieved. The PFM Long Dwell and Long Dwell HS sealing systems with equal temperature and pressure allow for a longer sealing time than the traditional rotary system. By taking advantage of the Time / Pressure element, Hermetic Sealing and high speed wrapping is, therefore, possible.



Detail of sealing with BDF material.

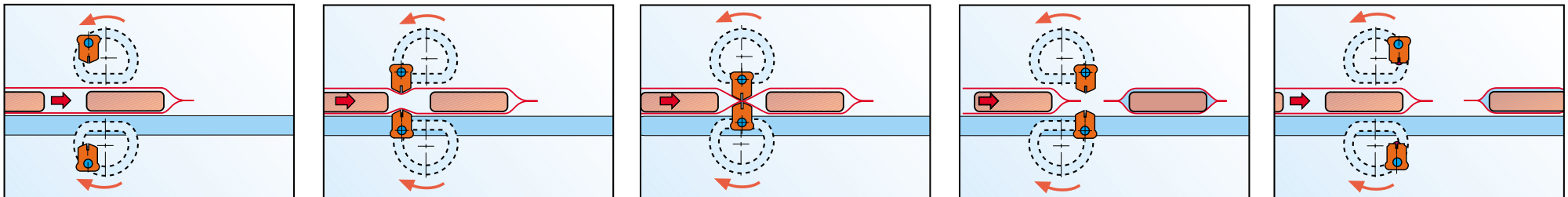

**The Long Dwell sealing system (patented PFM): one jaw per jaw support, superior flexibility, up to 140 cycles/min.**

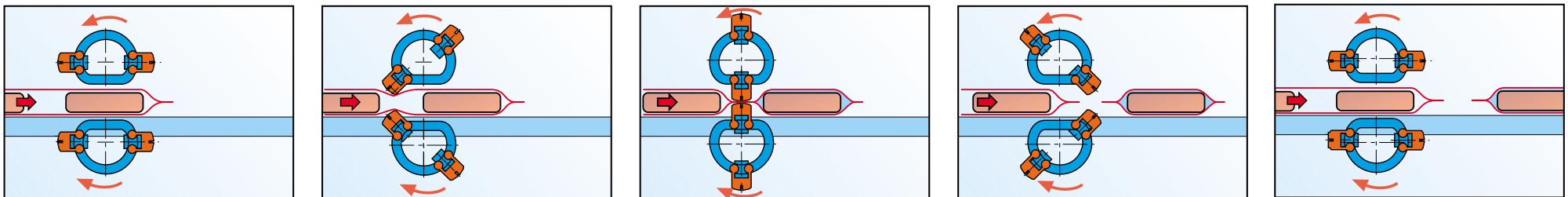

**The Long Dwell HS (High Speed) sealing system: 2 or 4 jaws for a maximum speed of 400 cycles/min.**



**Examples of wrapped products.**

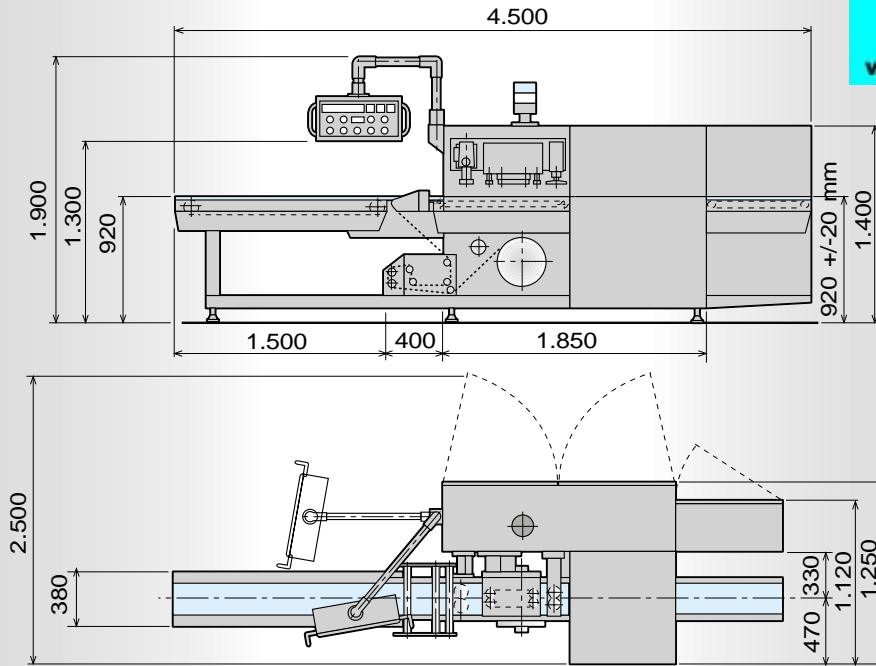

# Mistral

## Technical Data:

<b>Pack length:</b>	<b>min 100, max 350 mm*</b>
<b>Pack width:</b>	<b>min 10, max 320 mm*</b>
<b>Pack height:</b>	<b>max 110 mm</b>
<b>Reel width:</b>	<b>max 700 mm</b>
<b>Reel diameter:</b>	<b>max 350 mm</b>
<b>Crimper width:</b>	<b>max 350 mm*</b>
<b>Mechanical speed:</b>	<b>140 cycles/min LD version 400 cycles/min LDHS 4 crimpers version</b>
<b>Sealing unit:</b>	<b>Long Dwell (pat. PFM), Long Dwell HS</b>
<b>Available versions:</b>	<b>BA-BB, Servo, LDHS,LD,BDF</b>
<b>Power supply:</b>	<b>380 Volt 3 phase + neutral + earth</b>
<b>Weight:</b>	<b>1100 kg</b>
<b>Power consumption:</b>	<b>7 kw</b>
<b>Type of infeed:</b>	<b>In line (AFL ATL), ECF 90°</b>

\* Depending on sealing unit: LD or LDHS type

PFM reserves the right to modify technical data without previous notice.

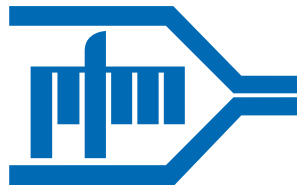

## Packaging Machinery

**PFM S.p.A. SEDE CENTRALE  
PACKAGING MACHINERY**

ITALIA  
Via Pasubio, 49 -  
Torrebelvicino (VI) ITALIA

Tel: 0445/570110  
Fax: 0445/570175  
Telex: 480405  
Internet: [www.pfm.it](http://www.pfm.it)  
E-mail: [pfm@pfm.it](mailto:pfm@pfm.it)

**PFM PACKAGING  
MACHINERY LTD**

GREAT BRITAIN  
Unit 8/9, Intercity Way  
LEEDS LS13 - 4LY

Tel: (+44) -113 -2393401  
Fax: (+44) -113 -2393402  
E-mail: [pfm@pfm-ltd.co.uk](mailto:pfm@pfm-ltd.co.uk)

**PFM PACKAGING  
MACHINERY  
CORPORATION  
USA & CANADA**

1271, Ringwell Ave.  
Newmarket  
Ont. Canada L3Y 7V1.

Tel: (+1) - 905 - 836 - 6709  
Fax: (+1) - 905 - 836 - 7763  
Internet: [www.pfmusa.com](http://www.pfmusa.com)  
E-mail: [info@pfmusa.com](mailto:info@pfmusa.com)

**PFM PACKAGING  
MACHINERY LTD**

RUSSIA  
UL. BOLSCIAIA NIKITSKAYA,  
31, kv.9  
103009 MOSCOW

Tel - Fax: (007) (095) 9265086