

**HAWK LAYOUT VIEW**

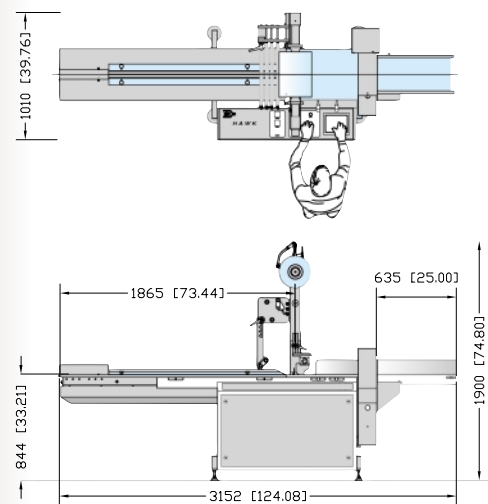

PRODUCT DIMENSIONS		
	MIN.	MAX.
A	2"	20"
B	0.2"	9.6"
C	0.1"	4.25"
D	Max. Package perimeter 18 3/8"	

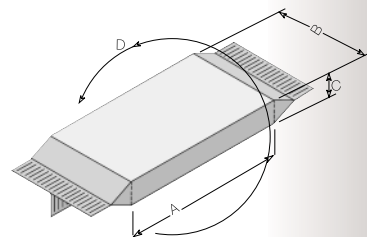

NOTE: Maximum product dimensions can not be tolerated simultaneously.

Technical data and layout provided for references purposes only.  
 PFM reserves the right to change/modify technical data and layout without prior notice.  
 Please contact PFM to confirm specifications

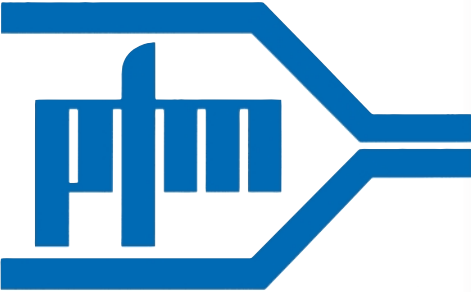

# Packaging Machinery



## HAWK

## PFM Group

Network of Packaging Solutions



**PFM PACKAGING MACHINERY CORP.**  
 USA & CANADA  
 1271 Ringwell Drive,  
 NEWMARKET, ONTARIO L3Y 7V1  
 Tel: (+1) 905-836-6709 • Fax: (+1) 905-836-7763  
 Web: www.pfmusa.com • E-mail: info@pfmusa.com



**PFM S.p.A.**  
 PACKAGING MACHINERY  
 ITALIAN HEADQUARTERS  
 Via Pasubio, 49  
 36036 TORREBELVICINO (VI)  
 ITALY  
 Web: www.pfm.it  
 E-mail: pfm@pfm.it



**PFM**  
 PACKAGING MACHINERY LTD.  
 PFM House, 2  
 Pilgrim Way, Stanningley  
 LEEDS - LS28 6LU  
 UNITED KINGDOM  
 Web: pfmuk.com  
 E-mail: pfm@pfm-td.co.uk



**PFM**  
 PACKAGING MACHINERY  
 GERMANY  
 Gewerbestraße, 31  
 D-21279 HOLLENSTEDT  
 Web: www.pfmgermany.de  
 E-mail: info@pfmgermany.de



**BG PACK S.p.A.**  
 PFM PACKAGING GROUP  
 Via C.A. Dalla Chiesa, 13  
 24048 TREVIOLO (BG) ITALY  
 E-mail: bgpack@bgpack.it



**MBP S.r.l.**  
 WEIGHERS AND BAG MAKERS  
 PFM PACKAGING GROUP  
 Via Toscanine, 48/B  
 46043 CASTIGLIONE DELLE  
 STIVIERE (MN) ITALY  
 Web: www.mbp.it  
 E-mail: info@mbp.it



**SPS S.p.A.**  
 ITALIANA PACK SYSTEMS  
 PFM PACKAGING GROUP  
 Via Salvemini, 23  
 28012 CRESSA (NO) ITALY  
 Web: www.spspack.com  
 E-mail: info@spspack.com

# HAWK



## Machine Description

Engineered to resolve the crucial challenges found in today's market, the Hawk sets itself apart from the pack. With speeds up to 120ppm, this user friendly horizontal form fill and seal machine is ideal for operations demanding top performance, increased flexibility, greater efficiency and low maintenance costs. The new flow wrapper from PFM is designed to incorporate the advanced components and features of an upsized machine into a compact and ergonomic design while maintaining quick and easy product changeovers. The versatility of the wrapper allows you to package a vast range of food and non-food items and utilize a wide variety of packaging materials (OPP, BOPP, Laminates, HLPE, Polyolefin, etc)

## Standard Features

- Compact, functional and ergonomic design
- Fully adjustable former
- Integrated motion controller/PLC complete with built in four line alphanumeric display to control the main machine functions
- Specific product settings can be saved and retrieved from the operator interface panel
- 2 axis system servo control
- Main frame and electrical cabinet in mild steel, Steel-it™ painted for improved protection
- 6' (1.8mt.) infeed conveyor
- Easily removable product pushers
- Three sets of finwheels
- One self centering film reel holder for a max. film width of 19.6" (500mm)
- Jaws up to 9.8" (250mm) wide and 6.7" (170mm) diameter
- Mechanical torque limiter on crimperhead
- Adjustable crimper height
- All parts in contact with the product are stainless steel or food approved plastic
- High precision temperature controllers

## Main Options

- Print registration
- 3 axis servo system with 3 brushless servo motors and colour HMI
- No product no bag and misplaced product detection
- 2nd self centering reel holder
- Extended infeed/discharge
- Quick change pitch
- Automatic infeeds
- Choice of open top fixed formers or articulated formers
- 2up bolt on jaws
- Hole punch jaws
- Full stainless version
- Shrink version

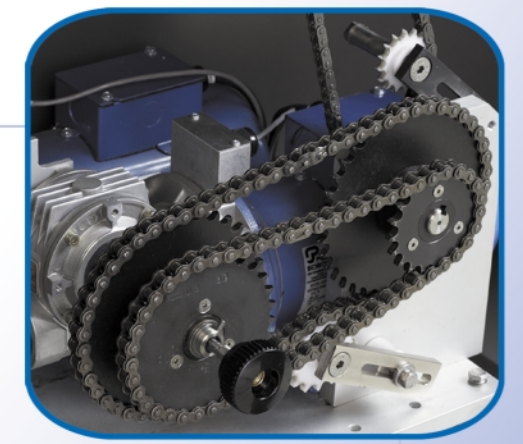

Drive Assembly with Quick Change Pitch (optional)

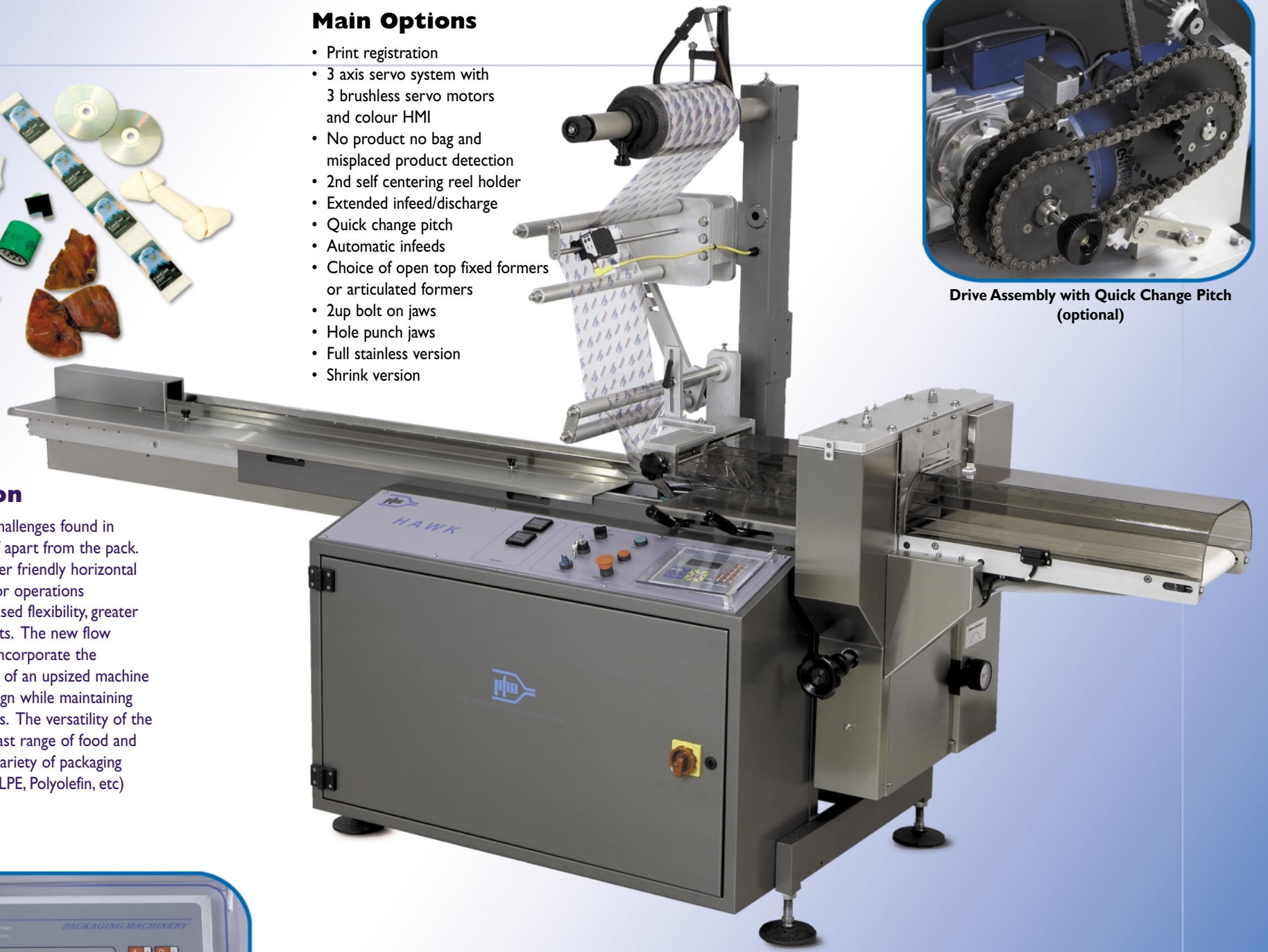

Control Panel

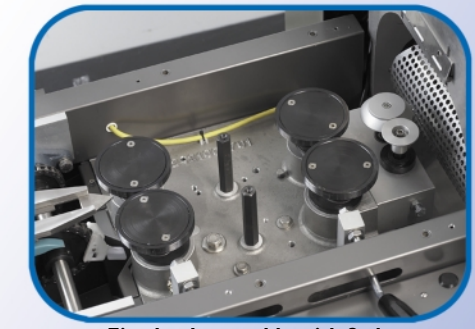

Finwheel assembly with 3rd set of foldover wheels

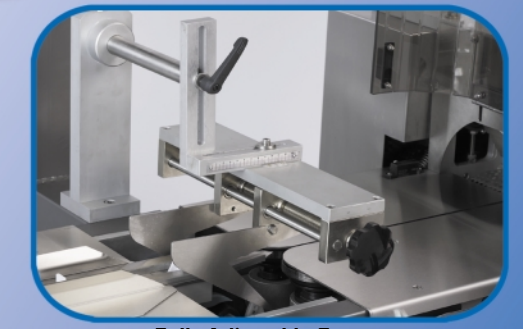

Fully Adjustable Former