



FSFCA Direct Expansion Universal Mount Fan Coil

Direct Expansion Fan Coil 12,000 - 60,000 BTUH

FSFCA NOMENCLATURE BREAKDOWN

Direct Expansion Universal Mount Fan Coil

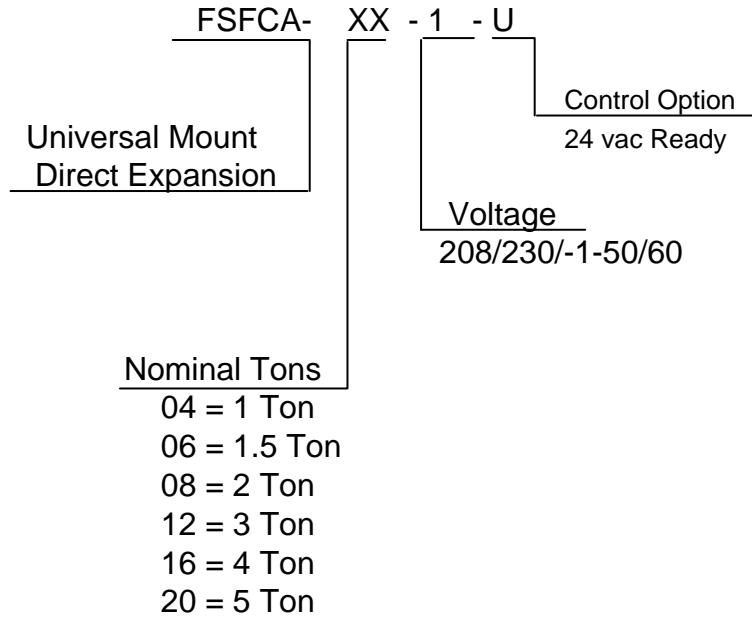

Available Model Numbers
FSFCA-04-1-U
FSFCA-06-1-U
FSFCA-08-1-U
FSFCA-12-1-U
FSFCA-16-1-U
FSFCA-20-1-U

HVAC Guide Specifications

Direct Expansion Universal Mount Fan Coil

Nominal Size:

12,000 – 60,000 BTUH

MultiAqua Model Number:

FSFCA-04-1-U

FSFCA-06-1-U

FSFCA-08-1-U

FSFCA-12-1-U

FSFCA-16-1-U

FSFCA-20-1-U

Part 1-General

1.01 System Description

MultiAqua direct expansion fan coils are manufactured with galvanized steel and high impact molded polymers.

1.02 Quality Assurance

- A. Certified in accordance with U.L. Standard 95, latest version (U.S.A.)
- B. Manufactured in a facility registered to ISO 9002, Manufacturing Quality Standard.
- C. Fully load tested at the factory.
- D. Damage resistant packaging.

1.03 Delivery, Storage and Handling

- A. Packaged and readied for shipment from the factory.
- B. Controls shall be capable of withstanding 150°F storage temperatures in the control compartment.
- C. Stored and handled per manufacturer's recommendations.

Part 2-Product

2.01 Equipment

- A. General:
 1. Unit shall be a factory assembled and tested direct expansion fan coil.
 2. Shall be assembled with high quality.
 3. Contained with the unit shall be all factory wiring, piping, associated controls and special accessories required prior to start up.
- B. Unit Cabinet:
 1. Composed of high impact polymers.
 2. Shall be internally insulated to insure quiet operation.
- C. Fan Motors:
 1. Shall be available in 208/230-1-50/60 vac.
 1. Fan motors shall be three speed, direct drive, and PSC type.
 2. Totally enclosed.
 3. Internal overload protected.
 4. Unit shall contain a swing motor to modulate the discharge air.
- D. Blower Wheels:
 1. Blower wheels are tangential and dynamically balanced.
- E. DX Coil:
 1. Coils manufactured with 3/8" rifled copper tubing mechanically bonded to aluminum fins.
 2. Coils shall be factory tested to 350 psig.
- F. Drain Pan:
 1. All drain pans shall be coated on both the interior and exterior with baked polyester powder to resist corrosion.
 2. The exterior of all drain pans shall be insulated with closed cell to prevent condensation.
 3. Pans shall contain a drain tubing that is accessible from the back, bottom and side of the unit.

G. Filters:

1. Unit shall contain 65% washable filters.

Part 3-Controls and Safeties

3.01 Controls

- A. Fan coils shall be completely factory wired and tested.
- B. Unit shall include a terminal block that is capable of incorporating a 24 vac thermostat.
- C. Controls shall be capable of incorporating an optional hard-wired thermostat.

3.02 Safeties:

- A. Fan coil shall contain a non reusable fuse on the secondary voltage side of the transformer.

Part 4-Operating Characteristics:

4.01 Electrical Requirements

- A. Electrical shall include a terminal block.
- B. Electrical power supply shall be rated to withstand 120°F operating ambient temperatures.

FSFCA Product Specifications & Capacity

Physical Data									
Model Number	Height (in)	Width (in)	Depth (in)	Weight (lbs)	Coil Rows FPI	Copper Diameter (in)	Liquid Line (in)	Suction Line (in)	Drain (in)
FSFCA-04-1-U	25.72	38.32	9.20	88.00	2-13	3/8	3/8	1/2	1/2
FSFCA-06-1-U	25.72	38.32	9.20	90.20	3-13	3/8	3/8	5/8	1/2
FSFCA-08-1-U	25.72	38.32	9.20	96.80	4-13	3/8	3/8	5/8	1/2
FSFCA-12-1-U	25.72	62.32	9.20	143.00	3-13	3/8	3/8	5/8	1/2
FSFCA-16-1-U	25.72	74.32	9.20	154.00	3-14	3/8	3/8	3/4	1/2
FSFCA-20-1-U	25.72	74.32	9.20	156.20	4-14	3/8	3/8	3/4	1/2

Electrical Data						
Model Number	Hi Speed CFM	Volts/Phase/Hertz	Motor HP	Full Load Ampacity	Fuse or HACR Circuit Breaker Per Circuit	
					Minimum Amps	Maximum Amps
FSFCA-04-1-U	400	208/230-1-50/60	1/15	0.54	.68	2
FSFCA-06-1-U	500		1/15	0.54	.68	2
FSFCA-08-1-U	550		1/8	1.59	1.99	3
FSFCA-12-1-U	750		1/8 & 1/20	2.09	2.49	4
FSFCA-16-1-U	1150		1/8 x 2	3.18	3.58	5
FSFCA-20-1-U	1200		1/8 x 2	3.18	3.58	5

Performance Data		
Model Number	CFM	Nominal Cooling Capacity
FSFCA-04-1-U	400	12,000
FSFCA-06-1-U	500	18,000
FSFCA-08-1-U	550	24,000
FSFCA-12-1-U	750	36,000
FSFCA-16-1-U	1150	48,000
FSFCA-20-1-U	1200	60,000

These specifications are subject to change without notice.

INSTALLATION and OPERATION MANUAL



FSFCA





INSTALLATION & OPERATING MANUAL

FSFCA Universal Mount Fan Coils
12,000-60,000 BTUH

----- CAUTION -----

Care must be taken when handling sheet metal. Sheet metal parts have sharp edges and could cause injury.

GENERAL

Read the entire contents of this manual before beginning installation. Multiaqua assumes no responsibility for equipment installed contradictory to any code requirement or installation instructions.

The components of this fan coil have been inspected at the factory and readied for shipment. Upon receiving the shipment a visual inspection of the packaging must be performed.

If any damage to the packaging is discovered, an inspection of the components must be performed and noted on the delivery documents. If component damage is found a damage claim must be filed by the receiving party against the delivery party immediately.

This product is designed and manufactured to permit installation in accordance with national codes. It is the installer's responsibility to install the product in accordance with national codes and/or prevailing local codes and regulations.

Care must be taken to ensure the structural integrity of the supporting members, clearances and provisions for servicing, power supply, coil connections and/or condensate removal. Before the installation ensure the structural strength of the supporting members is sufficient. See figure 1 for hanging weights of the fan coils.

This unit is designed to be installed in a

horizontal or vertical configuration. Fan coil can be mounted on a wall or ceiling. See figure 2 for fan coil and mounting bracket dimensions.

FAN COIL MODEL NUMBER	APPROXIMATED WEIGHTS (lbs)
FSFCA-04-1-U	88.00
FSFCA-06-1-U	90.20
FSFCA-08-1-U	96.80
FSFCA-12-1-U	143.00
FSFCA-16-1-U	154.00
FSFCA-20-1-U	256.20

Figure 1



INSTALLATION & OPERATING MANUAL

FSFCA Universal Mount Fan Coil
12,000-60,000 BTUH

FSFCA Mounting Bracket Dimensions (in)		
Model Number	A	B
FSFCA-04-1-U	36.49	13.00
FSFCA-06-1-U	36.49	13.00
FSFCA-08-1-U	36.49	13.00
FSFCA-12-1-U	48.30	13.00
FSFCA-16-1-U	71.97	13.00
FSFCA-20-1-U	71.97	13.00

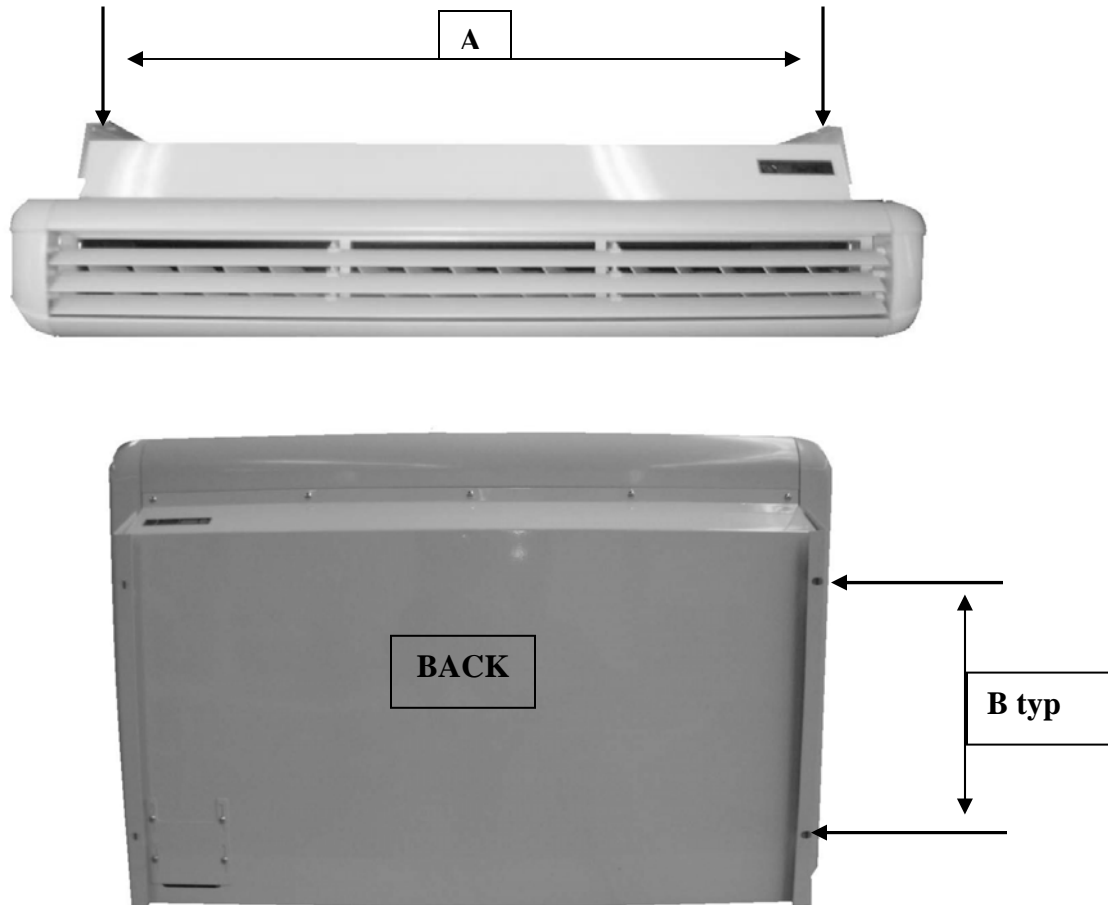

Figure 2



INSTALLATION & OPERATING MANUAL

FSFCA Universal Mount Fan Coils
12,000 – 60,000 BTUH

----- CAUTION -----

Care must be taken when handling sheet metal. Sheet metal parts have sharp edges and could cause injury.

INSTRUCTIONS FOR INSTALLING THE MOUNTING BRACKETS AND UNIT

1. The unit should be installed for horizontal and vertical discharge applications only.
2. Select position for unit and define direction of DX piping, drain and electrical wiring. Access to the above can be obtained from the right hand side bottom, back and side. See page 355 for access dimensions.

Figure 3, 4 and 5

3. Remove mounting brackets from both sides of unit.

Figure 6

4. Prepare mounting bolts for mounting unit under ceiling or on a wall at the distance provided in figure 2.
5. Select a location that permits even air flow throughout the room.
6. Select a location that has enough service space when the unit is mounted under the ceiling or on the wall

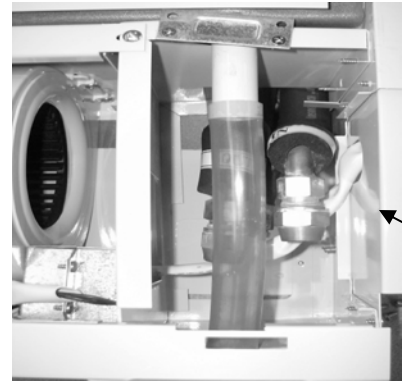

Figure 3

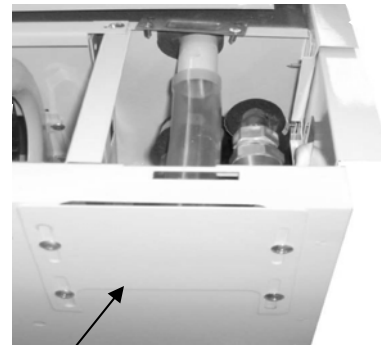

Figure 4



Figure 5



INSTALLATION & OPERATING MANUAL

FSFCA Universal Mount Fan Coils
12,000 – 60,000 BTUH

Piping Locations

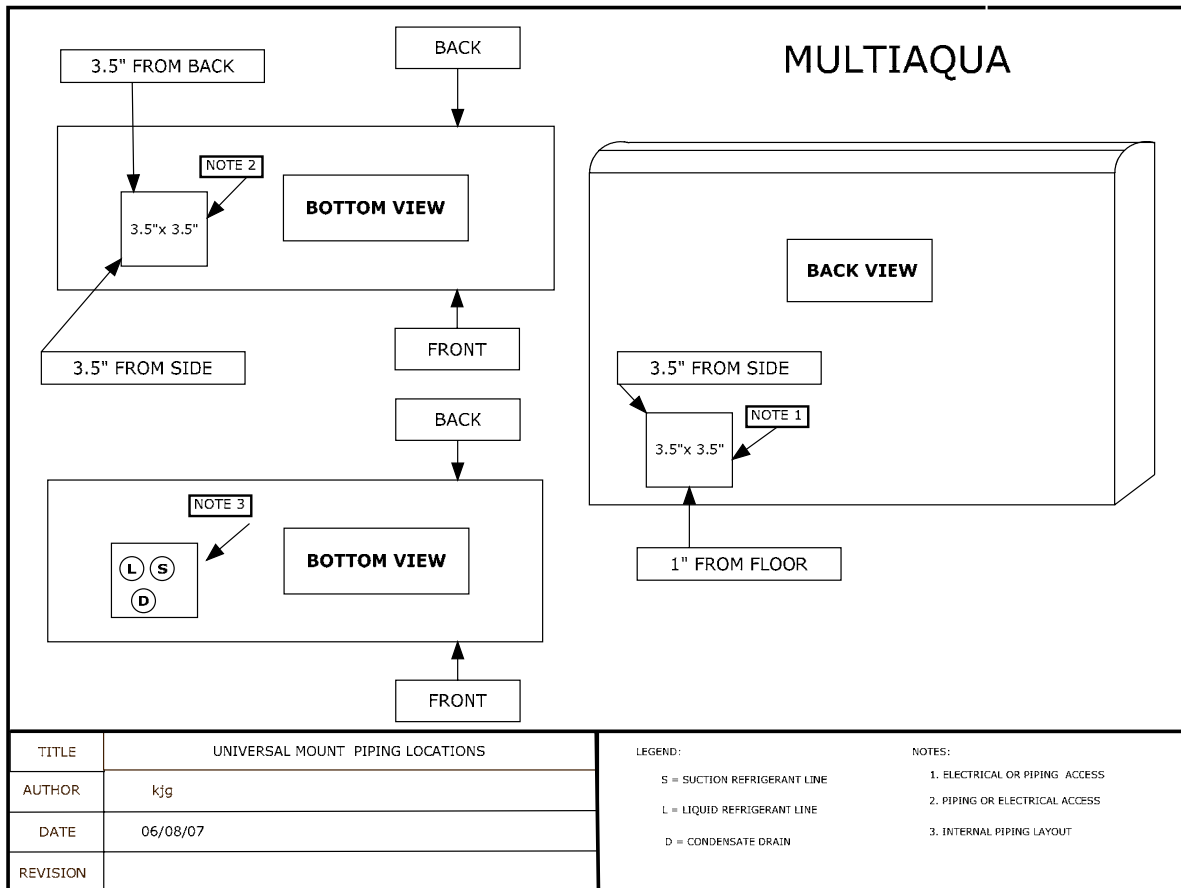



INSTALLATION & OPERATING MANUAL

FSFCA Universal Mount Fan Coils
12,000 – 60,000 BTUH

----- CAUTION -----

Care must be taken when handling sheet metal. Sheet metal parts have sharp edges and could cause injury.

INSTRUCTIONS FOR INSTALLING THE MOUNTING BRACKETS AND UNIT

7. Carefully place fan coil into place and align mounting holes in fan coil to the holes in the mounting bracket. Typical both sides.

Figure 6

8. Connections to the indoor unit are flared connections for both the liquid and suction lines to the fan coil.

Figure 7

9. Ensure tubing and fittings are in line with another before tightening nut to allow concentric seating of tube onto flare nut as to prevent leakage.

10. If installing a TXV at the condenser, ensure that the liquid line is properly insulated.

11. Connect the field drain line to the clear drain tubing provided on the drain pan of the fan coil. Ensure the drain line has a 1/4" of fall per foot. Insulate the condensate drain line to prevent sweating.

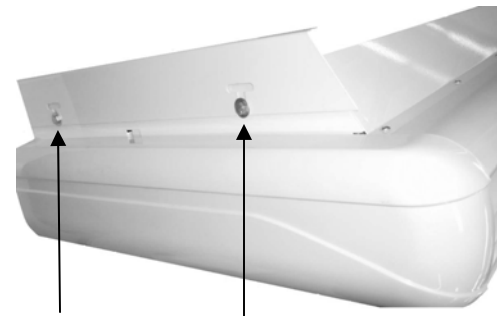

Figure 6

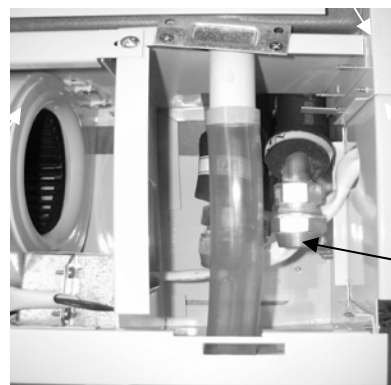

Figure 7

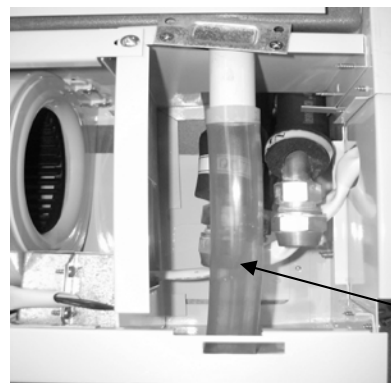
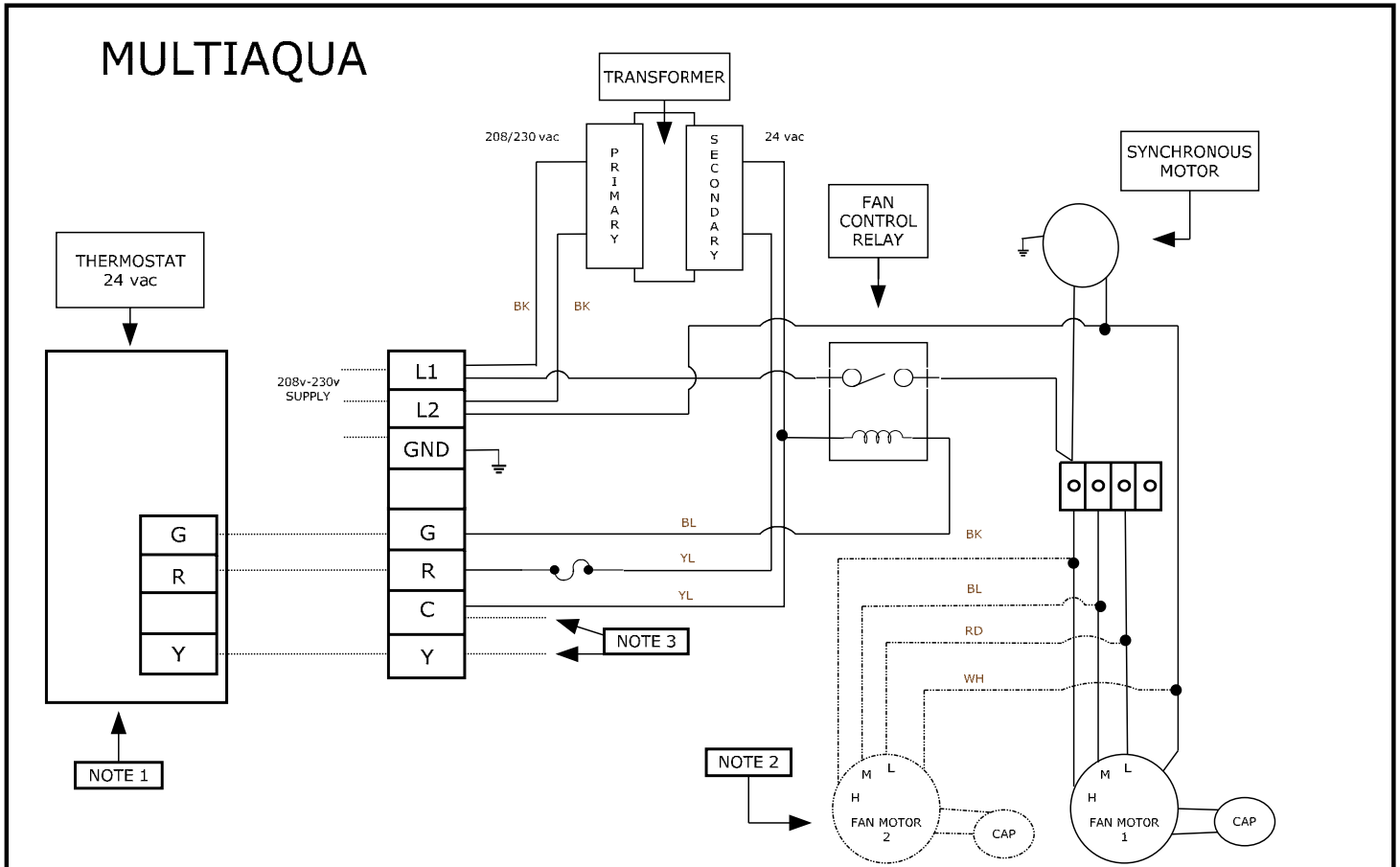

Figure 8

FSFCA-xx-1-U Wiring Diagram

208/230/-1-50/60



TITLE	FSFCA-xx-01-U-13 DX COOLING ONLY	LEGEND:	NOTES:
AUTHOR	kjg	— FACTORY WIRING	1. Thermostat supplied by others
DATE	05/14/07	- - - 2 MOTOR MODEL ONLY	2. Second motor installed on sizes 12, 16 and 20 only.
REVISION	050730007	⋯ FIELD WIRING	3. Y and C to condensing unit contactor (24vac)
		⏏ GROUND	
		— — FUSE	

FSFCA CERTIFIED DRAWING

FSFCA Certified Drawing
 Drawing # 0907400077

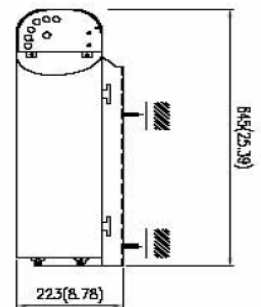
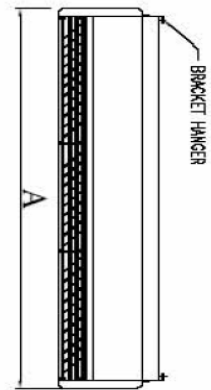
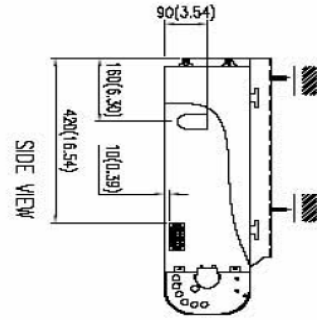

FRONT VIEW

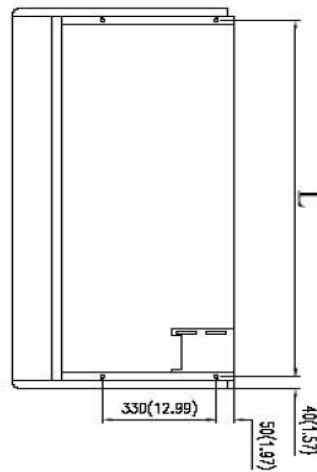

TOP VIEW



BACK VIEW

Model FSFCA		
MODEL	A	L
04	958(37.72)	878(34.57)
06	958(37.72)	878(34.57)
08	958(37.72)	878(34.57)
10	1258(49.53)	1178(46.38)
12	1258(49.53)	1178(46.38)
16	1858(73.15)	1178(46.38)
20	1858(73.15)	1178(46.38)

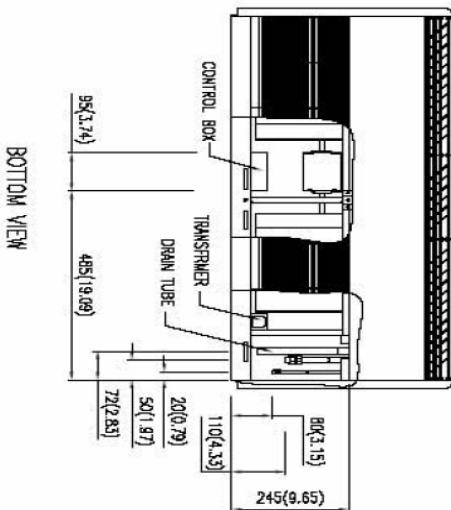

BOTTOM VIEW

