

**HOBART**701 S Ridge Avenue, Troy, OH 45374  
1-888-4HOBART • www.hobartcorp.com**N50  
MIXER****HOBART****STANDARD FEATURES**

- ½ H.P. Hobart Designed Fixed Speed Motor
- Gear-Driven Transmission
- Three Fixed Speeds
- Five Color Choices:
  - Cherry Red
  - Berry Blue
  - Creamy White
  - Plum Black
  - Hobart Gray
- Large, Easy-To-Reach Controls
- #10 Taper Attachment Hub
- Manual Bowl Lift
- 5-Quart Stainless Steel Bowl, "B" Flat Beater, "D" Wire Whip, "E" Dough Hook, Cord and Plug

**ACCESSORIES**

- Stainless Steel Bowl
- "B" Flat Beater
- Stainless Steel "B" Flat Beater
- "D" Wire Whip
- "E" Dough Hook

**MODEL**

- N50 – 5-Quart All Purpose Mixer with Bowl, Beater, Whip and Hook
- N50A – 5-Quart All Purpose Mixer with Bowl and Stainless Steel Beater (ASTM Standard C305)

Specifications, Details and Dimensions on Inside and Back.

**N50 MIXER**

# N50 MIXER



701 S Ridge Avenue, Troy, OH 45374  
1-888-4HOBART • www.hobartcorp.com

## SOLUTIONS/BENEFITS

### 1/2 H.P. Hobart Designed Motor

Durability

- Heavy-duty to meet the most demanding operations

### Gear-Driven Transmission

Durability, Reliability

- Ensures consistent performance and minimum downtime with positive drive under heavy loads

### Three Fixed Speeds

Flexibility, Reliability, Consistency

- For incorporating, blending, mixing ingredients
- Supports consistent results and thorough mixing

### Hobart Agitators

Durability, Flexibility

- Hobart manufactured agitators are designed for long-term usage under heavy-duty conditions
- Large array of agitators provide multiple uses for recipe and product processing

## N50 MIXER CAPACITY CHART

Recommended Maximum Capacities - dough capacities based on 70°F. water and 12% flour moisture.

PRODUCT	AGITATORS SUITABLE FOR OPERATION	N50
CAPACITY OF BOWL (QTS. LIQUID)		5
Egg Whites	D	1/2 pts.
Mashed Potatoes	B & C	3 lbs.
Mayonnaise (Qts. of Oil)	B or C or D	1 1/2 qts.
Meringue (Qts. of Water)	D	1/4 pts.
Waffle or Hot Cake Batter	B	2 qts.
Whipped Cream	D or C	3 pts.
Cake, Angel Food (8-10 oz. cake)	C or I	2
Cake, Box or Slab	B or C	4 lbs.
Cake, Cup	B or C	3 lbs.
Cake, Layer	B or C	3 lbs.
Cake, Pound	B	3 lbs.
Cake, Short (Sponge)	C or I	3 lbs.
Cake, Sponge	C or I	2 lbs.
Cookies, Sugar	B	3 lbs.
Dough, Bread or Roll (Lt.-Med.) 60% AR	§ ED	4 lbs.
Dough, Heavy Bread 55% AR	§ ED	—
Dough Pie	B & P	3 lbs.
Dough, Thin Pizza 40% AR (max. mix time 5 min.)	§‡ ED	—
Dough, Med. Pizza 50% AR	§‡ ED	—
Dough, Thick Pizza 60% AR	§‡ ED	—
Dough, Raised Donut 65% AR	ED	—
Dough, Whole Wheat 70% AR	ED	—
Eggs & Sugar for Sponge Cake	B & C or I	2 lbs.
Icing, Fondant	B	2 lbs.
Icing, Marshmallow	C or I	1/2 lbs.
Shortening & Sugar, Creamed	B	3 lbs.
Pasta, Basic Egg Noodle (max. mix time 5 min.)	ED	—

NOTE: % AR (% Absorption Ratio) - Water weight divided by flour weight. Capacity depends on moisture content of dough. Above capacities based on 12% flour moisture at 70°F water temperature.

§ If high gluten flour is used, reduce above dough batch size by 10%.

‡ The N50 requires a 50% reduction in batch size to mix in Speed 2 with 50% or less AR doughs.

**USE OF ICE REQUIRES A 10% REDUCTION IN BATCH SIZE.**

**1 gallon of water weighs 8.33 lbs.**

NOTE: Attachment hub should not be used while mixing.



701 S Ridge Avenue, Troy, OH 45374  
1-888-4HOBART • www.hobartcorp.com

# N50 MIXER

## SPECIFICATIONS

### MOTOR:

1/2 H.P., Hobart designed, ventilated, sleeve bearing, drip-proof enclosure.

Single Phase	100-120V	2.9 Amps
	230V	1.4 Amps

### ELECTRICAL:

100-120/60/1 - U L Listed for residential and commercial use. Also available in 100/50/1, 230/50/1, 220/60/1 and 230/60/1 - not submitted for U L Listing.

### CONTROLS:

Single pole, toggle-type, mechanically interlocked with transmission shift handle. Includes automatic circuit breaker with manual reset switch.

### TRANSMISSION:

Three speed selection transmission. Convenient shift handle mounted near "OFF" and "ON" switch.

### SPEEDS:

Three positive speeds - Low, Intermediate, and High.

	Agitator (RPM)	Attachment (RPM)
Low	136	60
Intermediate	281	124
High	580	255

### BOWL AND BEATERS:

Bowl is 5-quart capacity stainless steel. Locks at top and bottom of lift travel, which is controlled by convenient hand lever. A stainless steel beater is also available.

### FINISH:

Hybrid Powder Coat finish. Available in five colors: Cherry Red, Berry Blue, Creamy White, Plum Black, Hobart Gray.

### STANDARD EQUIPMENT:

Consists of the mixer unit with one (1) 5-quart stainless steel bowl, one (1) "B" flat beater, one (1) "D" wire whip, one (1) "E" dough hook, cord and plug.

### ATTACHMENT HUB:

Equipped with front-mounted Hobart standard #10 taper attachment hub, and any #10 size attachments may be used.

### ATTACHMENTS AND ACCESSORIES:

The following are available at extra cost:

- Stainless Steel Bowl
- "B" Flat Beater
- Stainless Steel "B" Flat Beater
- "D" Wire Whip
- "E" Dough Hook

**LISTED BY:** Underwriters Laboratories, Inc. and NSF International.

# N50 MIXER



701 S Ridge Avenue, Troy, OH 45374  
1-888-4HOBART • www.hobartcorp.com

## SPECIFICATIONS

**ELECTRICAL SPECIFICATIONS:** 100-120/60/1 - U L Listed for residential and commercial use. Also available in 100/50/1, 230/50/1, 220/60/1 and 230/60/1 - not submitted for U L Listing.

**WEIGHT:** 44½ lbs. net; 55 lbs. domestic shipping.

**WARRANTY:** Unit has full one-year warranty on parts and labor against manufacturer's defects. Carry-in warranty to local authorized Hobart service office.

## DETAILS AND DIMENSIONS

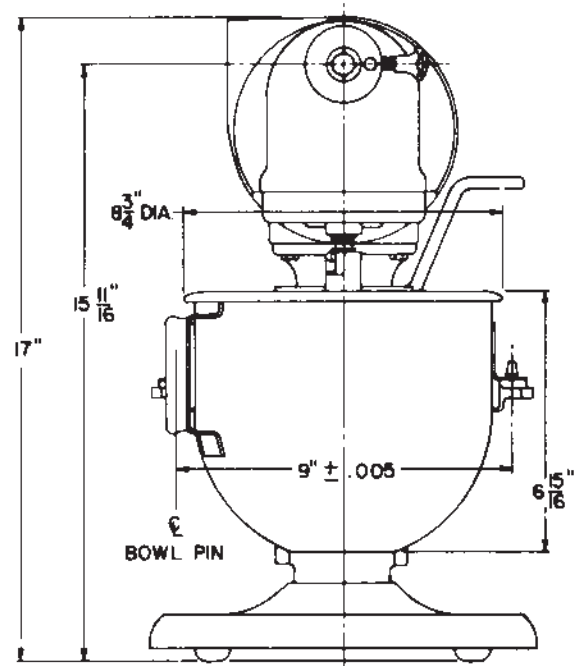
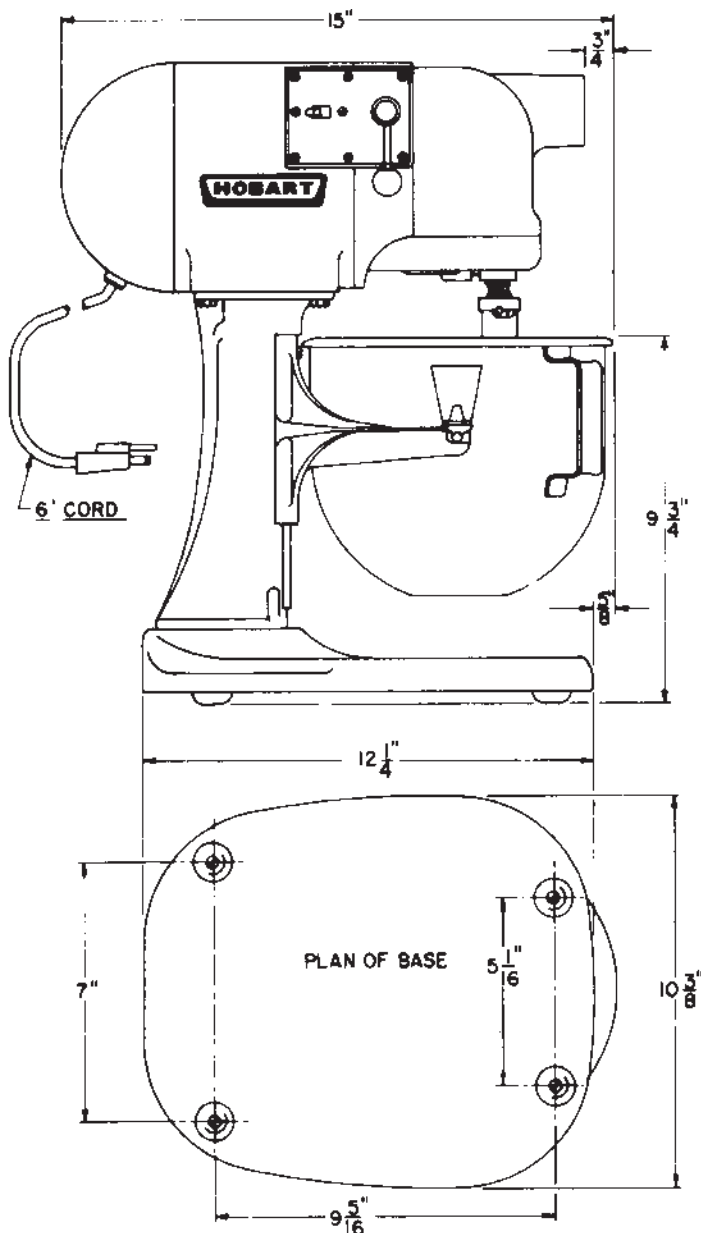

**WARNING**  
ELECTRICAL AND GROUNDING CONNECTIONS MUST COMPLY WITH THE APPLICABLE PORTIONS OF THE NATIONAL ELECTRICAL CODE AND/OR OTHER LOCAL ELECTRICAL CODES IN FORCE.

As continued product improvement is a policy of Hobart, specifications are subject to change without notice.