

# Operating Guide

## 1500 Series Dispenser

1500XL • 1500XL-15 • 1500XL-CA • 1500DV-15 • 1500D

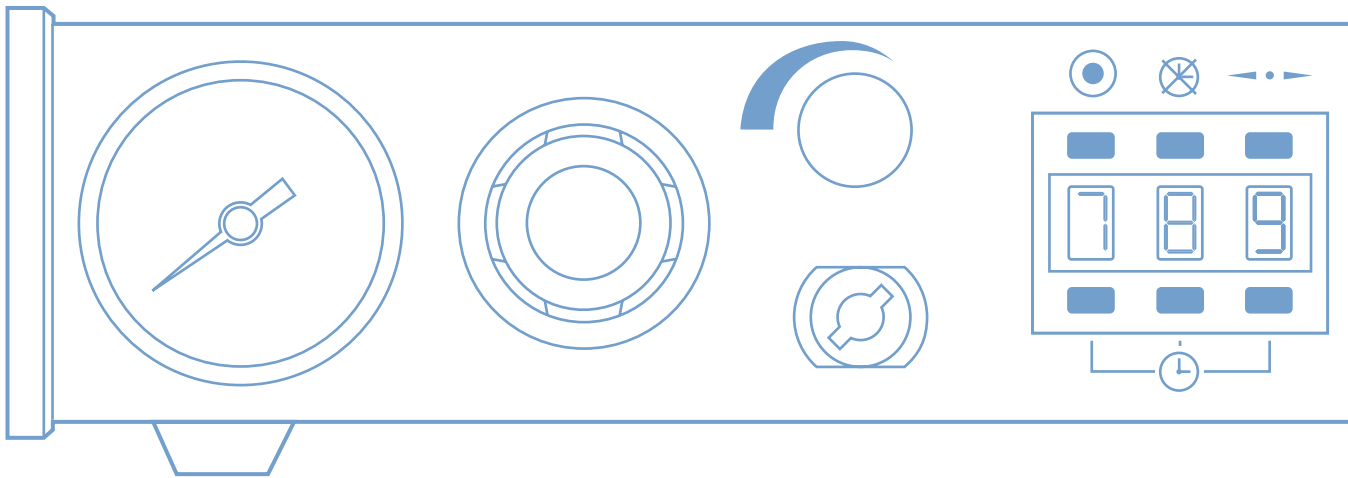

# Introduction

The advanced 1500 Series dispensers provide years of trouble-free, productive service. This Operating Guide will help you maximize the usefulness of your new dispenser.

Please spend a few minutes to become familiar with the controls and features of your new dispenser. Follow our recommended testing procedures. Review the helpful information we have included based on over 30 years of industrial dispensing experience.

Most questions you will have are answered in this Guide. However, if you need assistance, please do not hesitate to contact EFD or your authorized EFD distributor.



**US & Canada, call 800-556-3484.**

In Mexico, call 001-800-556-3484.

In the UK, ring free 0800 585733.

## The EFD Pledge

We pledge that you will be completely satisfied with our products. We endeavor to ensure that every EFD product is produced to our no-compromise quality standards.

If you feel that you are not receiving all the support you require, or if you have any questions or comments, I invite you to write or call me personally.

Our goal is to build not only the finest equipment and components, but also to build long-term customer relationships founded on superb quality, service, value and trust.

Peter Lambert, President

# Contents

Getting Started .....	4
Specifications	
First Steps .....	5
Unpacking the Dispenser & Activating your Ten Year No-fault Warranty	
Microprocessor Control .....	6-7
How to Use the Display and Control Pad	
1500XL - Setup & Use .....	8
Hookup .....	8-9
Setup for Testing .....	10-11
1500DV - Setup & Use .....	12
Hookup .....	12-13
Setup for Testing .....	14-15
1500D - Setup & Use .....	16
Hookup .....	16-17
Setup for Testing .....	18-19
Testing the Dispensers .....	20-21
Making Timed Deposits of Medium to Thick Fluids	
Changing Deposit Size and Drawing Stripes	
Programming Deposit Size	
How to Use the Vacuum Control .....	22-23
Making Timed Deposits of Watery-thin Fluids	
ULTRA Dispensing System .....	24-25
Loading the Barrel Reservoirs .....	26-27
1500XL and 1500D Schematics & Parts .....	28
1500DV Schematic & Parts .....	29
How the 1500 Series Dispensers Work .....	30
Reordering Components .....	31
Ten Year No-fault Warranty .....	32

This manual is for the express and sole use of EFD dispenser purchasers and users, and no portion of this manual may be reproduced in any form.

EFD, ULTRA System, LV Barrier, SmoothFlow, ZeroDraft, SafetyLok, SnapLok and DispenStand are trademarks of EFD Inc. ©2006 EFD, Inc.

*Meets applicable CSA and CE requirements.*

# Getting Started

We have organized this Guide to provide setup and testing procedures for the 1500 Series dispensers.

If you have the 1500XL, 1500XL-15 or 1500XL-CA, first review pages 8 - 11 which illustrate how to hook up the dispenser and what the controls do.

For the 1500DV or 1500DV-15, review pages 12 - 15.

If you have the 1500D, review pages 16 - 19.

Next, pages 20 - 21 show how to dispense the thick paste-like test material included in the Test Kit. These instructions are common to the 1500XL, 1500DV and 1500D dispensers.

Finally, pages 22 - 23 illustrate how to dispense low viscosity fluid using the vacuum control. These instructions are common to the 1500XL, 1500XL-15, 1500XL-CA, 1500DV and 1500DV-15 dispensers.

The rest of the information in this Guide applies to all of the 1500 Series dispensers.

## Specifications

Input Voltage: Selectable  
 100/120/220 VAC  
 50/60Hz

1500XL	}	14/12VA
1500XL-15		
1500XL-CA		
1500DV	}	18/15VA
1500DV-15		
1500D		14/12VA

Internal Voltage: 24 VDC

Foot Pedal Voltage: 5.5 VDC

Cycle Rate: >600/minute

Time Control: microprocessor with  
 0.00005 second repeatability

Time Range: programmable  
 0.001 to 99.9 seconds

Initiation: momentary

Air Input: 80 to 100 psi  
 (5.5 to 6.9 bar)

Air Output:

1500XL, 1500DV, 1500D  
 0 to 100 psi (0 to 6.9 bar)

1500XL-15, 1500XL-CA, 1500DV-15  
 0 to 15 psi (0 to 1.0 bar)

### 1500XL, 1500XL-15, 1500XL-CA

10<sup>3</sup>/<sub>8</sub> x 8<sup>1</sup>/<sub>2</sub> x 2<sup>3</sup>/<sub>8</sub>" 4 lb 14 oz  
 (26.4 x 21.6 x 6.7 cm) (2.21 kg)

### 1500DV, 1500DV-15

10<sup>3</sup>/<sub>8</sub> x 8<sup>1</sup>/<sub>2</sub> x 2<sup>3</sup>/<sub>8</sub>" 5 lb 2 oz  
 (26.4 x 21.6 x 6.7 cm) (2.32 kg)

### 1500D

8<sup>3</sup>/<sub>8</sub> x 8<sup>1</sup>/<sub>2</sub> x 2<sup>3</sup>/<sub>8</sub>" 4 lb 2 oz  
 (21.9 x 21.6 x 6.7 cm) (1.87 kg)

## First Steps

First: Unpack and use the checklist enclosed with the Dispenser Kit to identify all items. If there is any discrepancy, please call us immediately.

Second: Power and compressed plant air should be available where the dispenser is to be set up. Air pressure should be between 80 and 100 psi (5.5 and 6.9 bar). If you are not using an EFD five-micron filter regulator #2000F755, **be certain your plant air is properly filtered and dry and a regulated, constant air pressure is supplied to the dispenser.**

**Note:** Model 15000XL-CA is supplied with an EFD five-micron filter regulator with coalescing filter (#2000F756).

Bottled nitrogen can be used.

**Warning:** If high pressure bottled air or nitrogen is used, a high pressure regulator must be installed on the bottle and set at 100 psi maximum. The 2000F755 filter regulator is not recommended.

Check the voltage label to be certain it is set to the available power.

Third: Now is a good time to ACTIVATE your extended Ten (10) Year No-fault Warranty. Please fill in and return the postage paid Warranty card. Or if you prefer, call the appropriate toll-free number listed below, provide the serial number of your dispenser and respond to a few short questions. You are then assured of complete protection for 10 years.



**US & Canada, call 800-556-3484.**

In Mexico, call 001-800-556-3484.

In the UK, ring free 0800 585733.

# Microprocessor Control

Once your dispenser is set up, return to these pages to familiarize yourself with the various functions of the microprocessor controls.

Disconnect the male quick-connect on the barrel adapter hose from the dispenser before testing each function to prevent inadvertent fluid dispensing.

## 1 Program mode

Press to clear the display. Any decimals will disappear and the time range will reset to 000. Display alternates bright and dim to indicate the program mode.

## 2 Timer bypass mode

Press once and the display changes to --- (dashes). Foot pedal now controls liquid flow. Press again and dashes are replaced by previously set time.

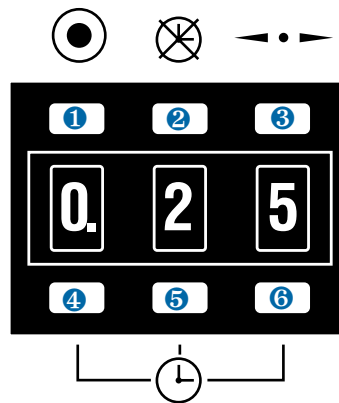

## 3 Decimal button

Press to move decimal. When no decimal shows, time range is .000 to .999 seconds.

## 4 5 6 Time set buttons

Each button sequentially controls the display digit in that panel. Each press advances the display 0.....9 and repeats.

# How to Use the Display and Control Pad



.050 seconds



0.50 seconds



5 seconds

## To change the displayed time



Start by setting the digits at zero. Press the  button twice to zero the display.

Press the button below each panel to set a specific time. Be sure the decimal is in the correct place for the time you require. (Cannot be done in program mode.)

## Timer bypass mode (foot pedal control)

Press the  button, - - - (dashes) will appear. To get back in the time mode, press again. (This mode is used for filling the tip and making by-eye deposits. Cannot be done in program mode.)

## Program mode

Press the  button once. Display flashes. Use the foot pedal to establish deposit size (and time). Press  again, flashing stops and programmed time is displayed. Decimal will automatically move to appropriate position.

## Change decimal position

Press the  button to move the decimal during manual time set. No decimal shows when time range is .000 to .999 seconds. (Cannot be done in program mode.)

## To interrupt the dispense cycle

The foot pedal is pressed while dispensing. To interrupt dispensing in mid-cycle and reset to the original time display, press the pedal a second time.

**Note:** For hookup purposes, connections for the 1500XL, 1500XL-15 and 1500XL-CA models are identical.

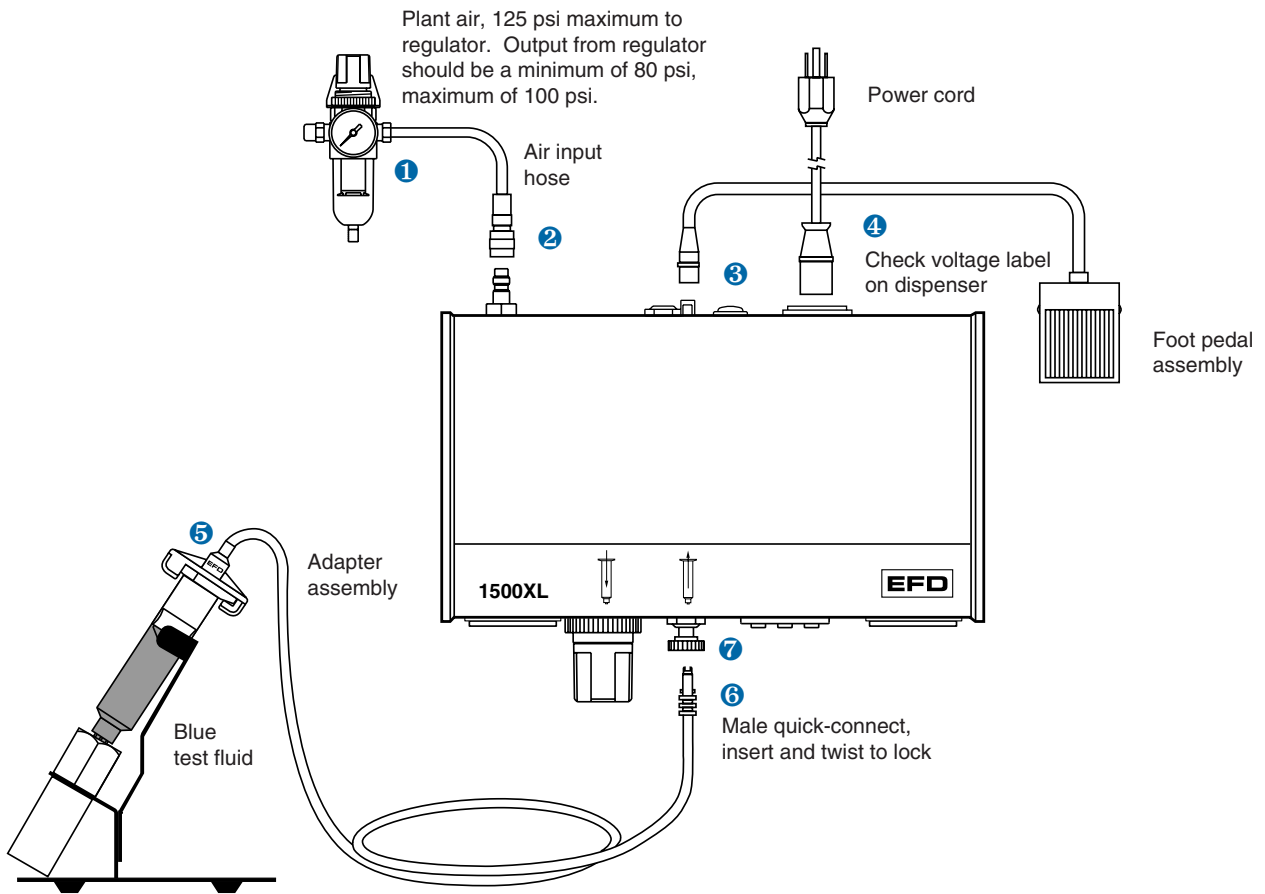

# 1500XL -- Hookup

- ❶ Connect the air input hose to a plant air source. Set plant air supply within 80 to 100 psi (5.5 to 6.9 bar). Where required, use an EFD five-micron filter regulator #2000F755 (see Warranty).
- ❷ Attach the air input hose coupling to the dispenser. Pull back metal ring to attach to dispenser.
- ❸ Plug in the polarized foot pedal connector.
- ❹ Check the voltage label on the input voltage selector cartridge. To change the voltage, remove the voltage selector from the cartridge, rotate it and position the correct voltage to show through the cartridge window. Replace the cartridge into the power cord receptacle and insure that both sides snap securely into position. Install the power cord.

**Note:** For 1500XL-15 and 1500XL-CA dispensers, use the test barrel filled with clear fluid and the red 25 gage tip. Refer to "Making Timed Deposits of Watery-thin Fluids" on page 22.

- ❺ Attach the 10cc barrel pre-filled with blue, nontoxic test fluid (included with the dispenser) to the 10cc adapter head.

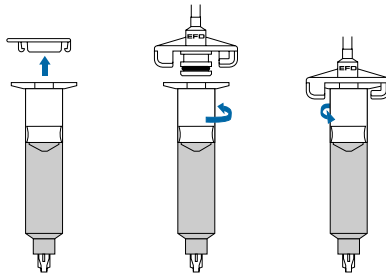

- ❻ Take the 10cc adapter assembly (#5150 on the adapter head) and insert the black, male quick-connect into the air output fitting on the front panel and turn clockwise to lock. Place the barrel in the barrel stand.
- ❼ During the initial testing, you will not use the vacuum control. Keep this control shut off (turned completely clockwise—do not force).

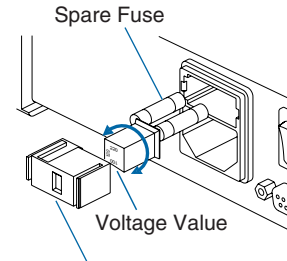

Cartridge Window  
(check voltage indicated)

**Note:** The dispenser is shipped with the fuse cartridge set for 120 VAC input.

### I/O Connection

The 9 pin D connector and internal circuitry provides external initiate with end-of-cycle feedback. The pin connections are shown below. For complete schematic and detailed information, please contact EFD.

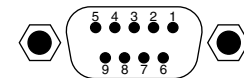

### Pin Function

- |                    |              |
|--------------------|--------------|
| 1. Initiate +      | } 5-24 VDC   |
| 2. Initiate -      |              |
| 3. Output +        | } 5-24 VDC   |
| 4. Output -        |              |
| 5. Contact Closure | } 250 mA Max |
| 6. Chassis Ground  |              |
| 7. Contact Closure |              |
| 8. Not Used        |              |
| 9. Not Used        |              |

**Note:** A 9-pin male connector assembly is available from EFD (order part #7154).

## 1500XL CONTROLS & CONNECTIONS

**Note:** The controls for the 1500XL, -15 and -CA models are identical.

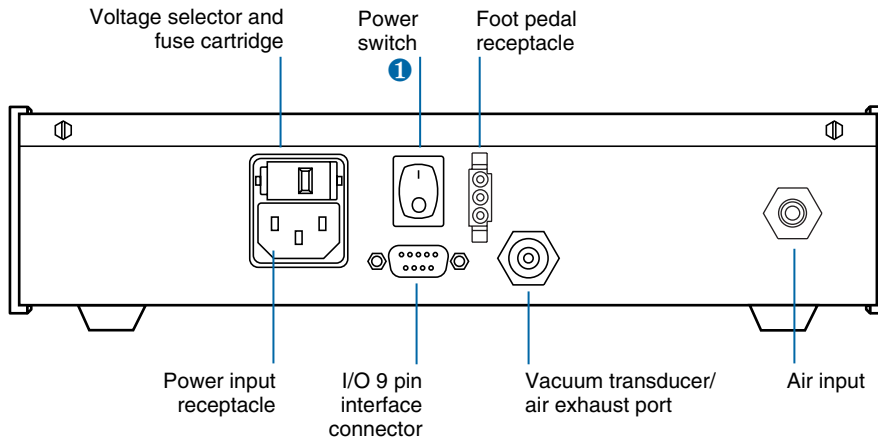
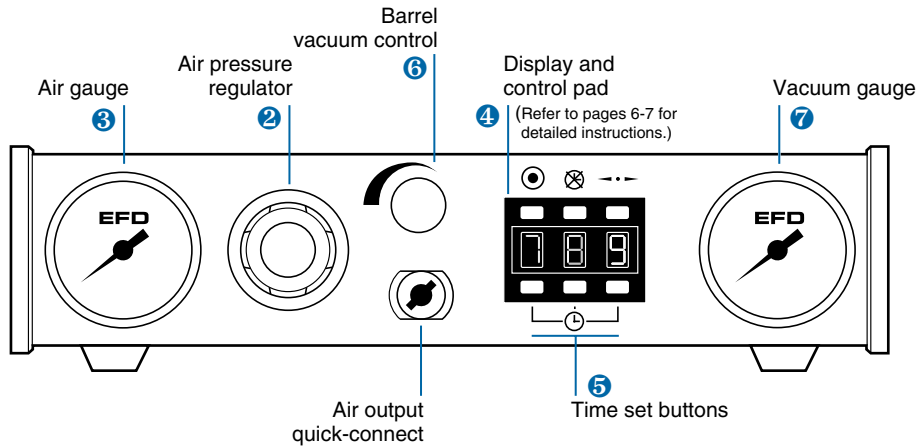

# 1500XL -- Setup for Testing

Power switch ① should be off.

The amount of material dispensed each cycle depends on the combination of air pressure, time of air pulse, viscosity of material and dispensing tip size.

**Note:** The following steps refer to the 1500XL dispenser. For the 1500XL-15 and 1500XL-CA dispensers, refer to "Making Timed Deposits of Watery-thin Fluids" on page 22.

The first step is to remove the tip cap from the prefilled barrel of blue test material (twist and pull). Replace it with an 18 gage (green) tapered dispensing tip. Press the tip on and twist clockwise to lock.

Pull out air pressure regulator knob ② until it "clicks" into the unlocked position. Turn clockwise to adjust the air pressure to 30 psi (2.1 bar) for the initial tests.

Always set the pressure desired by turning the air regulator knob ② clockwise. To reduce the pressure, turn the knob counterclockwise until the gauge ③ reads a lower pressure than desired. Then increase and stop at desired pressure. Push knob in to lock.

Press power switch ① to turn on the dispenser. The digital display will show the time that was set when the dispenser was turned off.

Set the digital time to 0.25 seconds as follows:

On the display and control pad ④, press the decimal button  until the decimal is moved to the left and appears in the left display segment. This puts the time range within 0.00 to 0.99 seconds. (Fig. 1)

Now, use the time set buttons ⑤ to set the length of the air pulse. Press the bottom right button until a 5 shows. Then press the bottom middle button until a 2 shows. Finally, press the bottom left button until a 0 shows. This display is equal to 0.25 seconds. (Fig. 2)

Be sure barrel vacuum control ⑥ is turned off. In the initial tests, the vacuum pressure gauge ⑦ will indicate zero pressure.

Please continue to page 20 for test procedures.

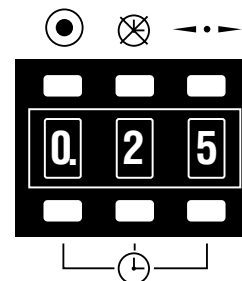

Refer to pages 6 - 7 for complete details on the microprocessor controls.



(Fig. 1)

Note: For .000 time, the decimal is not indicated. Instead, the 000 display is shown.



(Fig. 2)

**Note:** For hookup purposes, the connections for the 1500DV and 1500DV-15 models are identical.

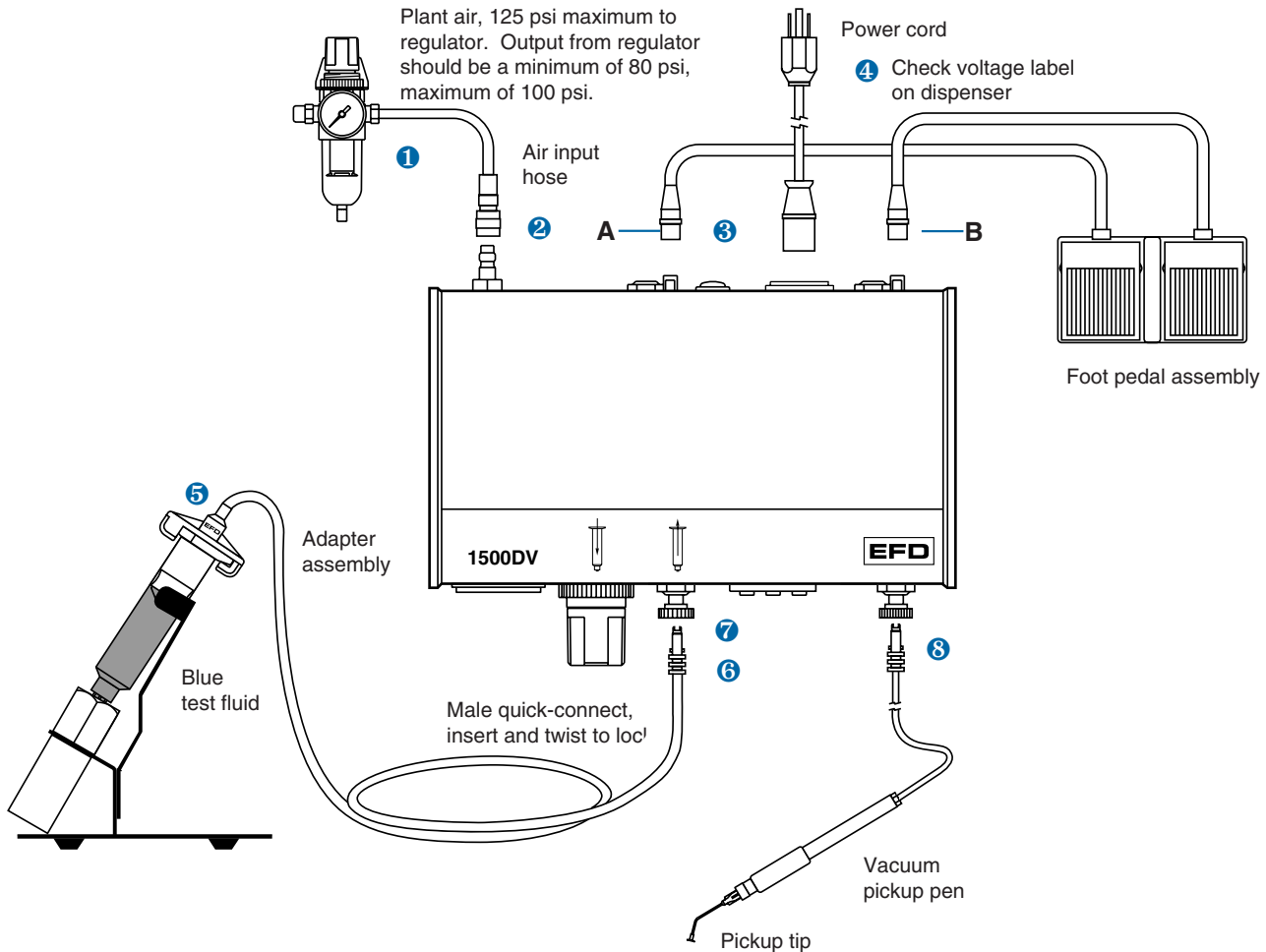

# 1500DV -- Hookup

- ❶ Connect the air input hose to a plant air source. Set plant air supply within 80 to 100 psi (5.5 to 6.9 bar). Where required, use an EFD five-micron filter regulator #2000F755 (see Warranty).
- ❷ Attach the air input hose coupling to the dispenser. Pull back metal ring to attach to dispenser.
- ❸ Plug in the polarized foot pedal connectors (A & B).
- ❹ Check the voltage label on the input voltage selector cartridge. To change the voltage, remove the voltage selector from the cartridge, rotate it and position the correct voltage to show through the cartridge window. Replace the cartridge into the power cord receptacle and insure that both sides snap securely into position. Install the power cord.

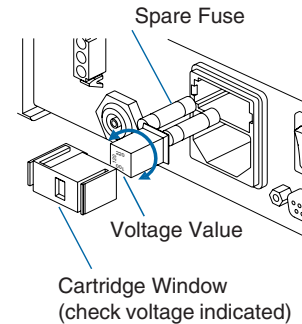

**Note: The dispenser is shipped with the fuse cartridge set for 120 VAC input.**

**Note:** For the 1500DV-15 dispenser, use the test barrel filled with clear fluid and the red 25 gage tip. Refer to "Making Timed Deposits of Watery-thin Fluids" on page 22.

- ❺ Attach the 10cc barrel prefilled with blue, nontoxic test fluid (included with the dispenser) to the 10cc adapter head.

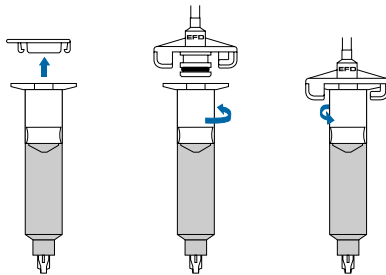

- ❻ Take the 10cc adapter assembly (#5150 on the adapter head) and insert the black, male quick-connect into the air output fitting on the front panel and turn clockwise to lock. Place barrel in the barrel stand.
- ❼ During the initial testing, you will not use the barrel vacuum control. Keep this control shut off (turned completely clockwise—do not force).
- ❽ Plug in the vacuum pickup pen. Select and attach a pickup pad/tip.

**I/O Connection**  
 The 9 pin D connector and internal circuitry provides external initiate with end-of-cycle feedback. The pin connections are shown below. For complete schematic and detailed information, please contact EFD.

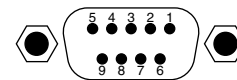

Pin	Function
1.	Initiate +
2.	Initiate -
3.	Output +
4.	Output -
5.	Contact Closure
6.	Chassis Ground
7.	Contact Closure
8.	Not Used
9.	Not Used

**Note:** A 9-pin male connector assembly is available from EFD (order part #7154).

1500DV

## 1500DV CONTROLS & CONNECTIONS

**Note:** The controls for the 1500DV and 1500DV-15 models are identical.

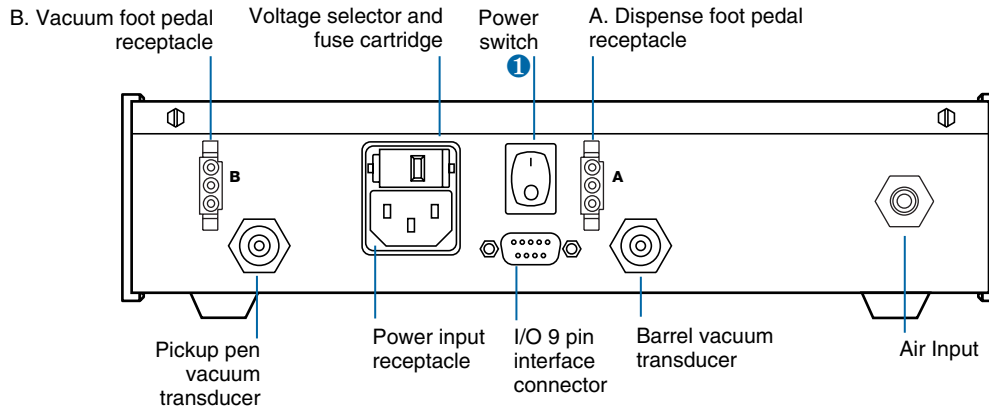
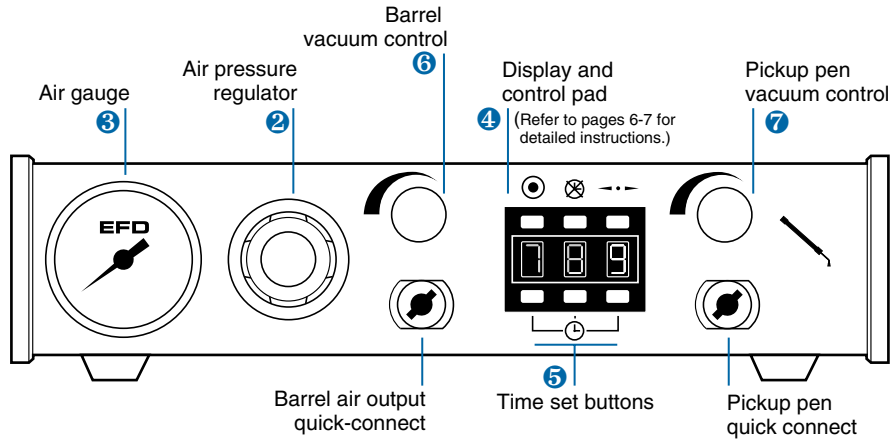

# 1500DV -- Setup for Testing

Power switch ❶ should be off.

The amount of material dispensed each cycle depends on the combination of air pressure, time of air pulse, viscosity of material and dispensing tip size.

**Note:** The following steps refer to the 1500DV dispenser. For the 1500DV-15 dispenser, refer to "**Making Timed Deposits of Watery-thin Fluids**" on page 22.

The first step is to remove the tip cap from the prefilled barrel of blue test material (twist and pull). Replace it with an 18 gage (green) tapered dispensing tip. Press the tip on and twist clockwise to lock.

Pull out air pressure regulator knob ❷ until it "clicks" into the unlocked position. Turn clockwise to adjust the air pressure to 30 psi (2.1 bar) for the initial tests.

Always set the pressure desired by turning the air regulator knob ❷ clockwise. To reduce the pressure, turn the knob counterclockwise until the gauge ❸ reads a lower pressure than desired. Then increase and stop at desired pressure. Push knob in to lock.

Press power switch ❶ to turn on the dispenser. The digital display will show the time that was set when the dispenser was turned off.

Set the digital time to 0.25 seconds as follows:

On the display and control pad ❹, press the decimal button ◀•▶ until the decimal is moved to the left and appears in the left display segment. This puts the time range within 0.00 to 0.99 seconds. (Fig. 1)

Now, use the time set buttons ❺ to set the length of the air pulse. Press the bottom right button until a 5 shows. Then press the bottom middle button until a 2 shows. Finally, press the bottom left button until a 0 shows. This display is equal to 0.25 seconds. (Fig. 2)

Be sure barrel vacuum control ❻ is turned off.

**Note:** A separate vacuum control ❼ powers the pickup pen. The second foot pedal B turns on the solenoid that controls the vacuum. Turn the control counterclockwise until sufficient vacuum is obtained. Place the pad on the component and press the foot pedal to provide pickup vacuum. Position the component where needed and release the foot pedal.

Please continue to page 20 for test procedures.

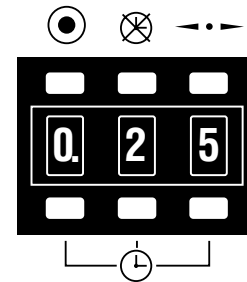

Refer to pages 6 - 7 for complete details on the microprocessor controls.



(Fig. 1)

Note: For .000 time, the decimal is not indicated. Instead, the 000 display is shown.



(Fig. 2)

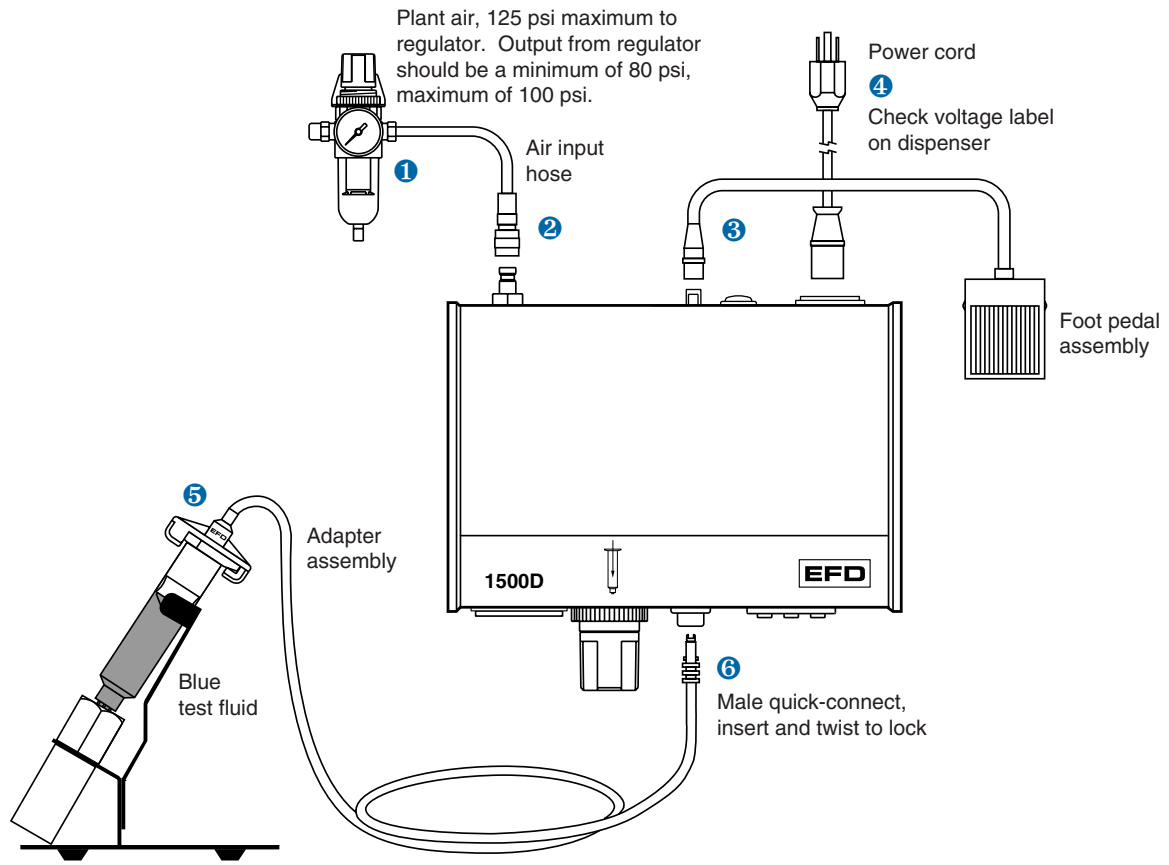

# 1500D -- Hookup

- 1 Connect the air input hose to a plant air source. Set plant air supply within 80 to 100 psi (5.5 to 6.9 bar). Where required, use an EFD five-micron filter regulator #2000F755 (see Warranty).
- 2 Attach the air input hose coupling to the dispenser. Pull back metal ring to attach to dispenser.
- 3 Plug in the polarized foot pedal connector.
- 4 Check the voltage label on the input voltage selector cartridge. To change the voltage, remove the voltage selector from the cartridge, rotate it and position the correct voltage to show through the cartridge window. Replace the cartridge into the power cord receptacle and insure that both sides snap securely into position.

Install the power cord.

- 5 Attach the 10cc barrel prefilled with blue, nontoxic test fluid (included with the dispenser) to the 10cc adapter head.

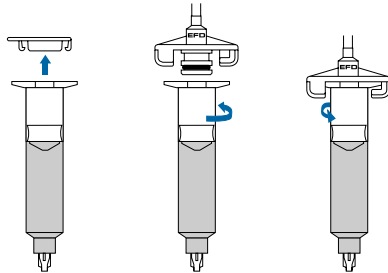

- 6 Take the 10cc adapter assembly (#5150 on the adapter head) and insert the black, male quick-connect into the air output fitting on the front panel and turn clockwise to lock. Place the barrel in the barrel stand.

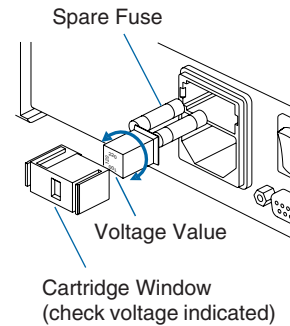

**I/O Connection**  
 The 9 pin D connector and internal circuitry provides external initiate with end-of-cycle feedback. The pin connections are shown below. For complete schematic and detailed information, please contact EFD.

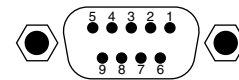

Pin	Function
1.	Initiate +
2.	Initiate -
3.	Output +
4.	Output -
5.	Contact Closure
6.	Chassis Ground
7.	Contact Closure
8.	Not Used
9.	Not Used

**Note:** A 9-pin male connector assembly is available from EFD (order part #7154).

## 1500D CONTROLS & CONNECTIONS

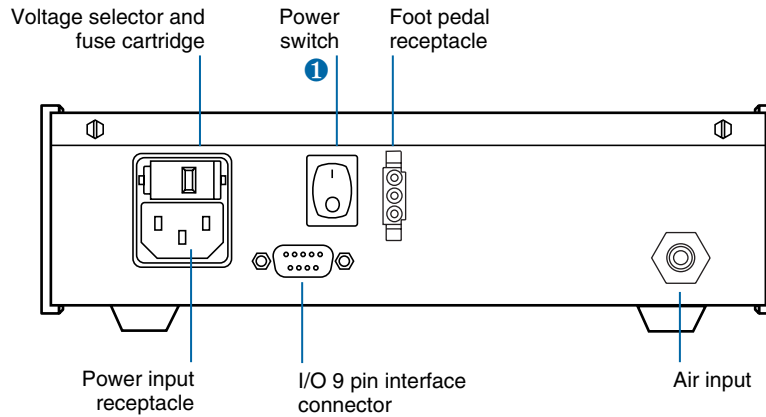
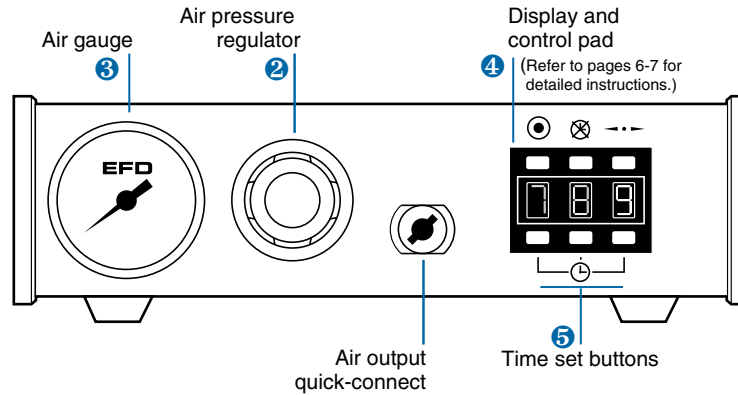

# 1500D -- Setup for Testing

Power switch ❶ should be off.

The amount of material dispensed each cycle depends on the combination of air pressure, time of air pulse, viscosity of material and dispensing tip size.

The first step is to remove the tip cap from the prefilled barrel of blue test material (twist and pull). Replace it with an 18 gage (green) tapered dispensing tip. Press the tip on and twist clockwise to lock.

Pull out air pressure regulator knob ❷ until it "clicks" into the unlocked position. Turn clockwise to adjust the air pressure to 30 psi (2.1 bar) for the initial tests.

Always set the pressure desired by turning the air regulator knob ❷ clockwise. To reduce the pressure, turn the knob counterclockwise until the gauge ❸ reads a lower pressure than desired. Then increase and stop at desired pressure. Push knob in to lock.

Press power switch ❶ to turn on the dispenser. The digital display will show the time that was set when the dispenser was turned off.

Set the digital time to 0.25 seconds as follows:

On the display and control pad ❹, press the decimal button ◀ • ▶ until the decimal is moved to the left and appears in the left display segment. This puts the time range within 0.00 to 0.99 seconds. (Fig. 1)

Now, use the time set buttons ❺ to set the length of the air pulse. Press the bottom right button until a 5 shows. Then press the bottom middle button until a 2 shows. Finally, press the bottom left button until a 0 shows. This display is equal to 0.25 seconds. (Fig. 2)

Please continue to page 20 for test procedures.

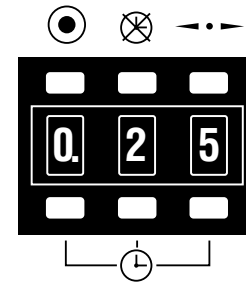

Refer to pages 6 - 7 for complete details on the microprocessor controls.



(Fig. 1)

Note: For .000 time, the decimal is not indicated. Instead, the 000 display is shown.



(Fig. 2)

# Testing the Dispensers

## Making Timed Deposits of Medium to Thick Fluids (1500XL, 1500DV and 1500D)

You are now ready to test the prefilled, nontoxic, blue test fluid. This material is representative of thick, non-leveling fluids like sealants, pastes or greases.

Check your initial settings:

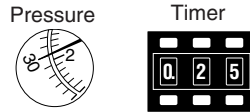

- Air gauge reads 30 psi.
- Timer is set at 0.25 (refer to page 6 for complete details on the microprocessor controls).
- Green tapered tip is on the test barrel.
- Press the timer bypass button once so that dashes appear in the display segments. (Fig. 1)

Holding the barrel as shown, rest the tip on a piece of paper. Press the foot pedal until the tip fills and some fluid is pushed out onto the paper. Repeat this whenever you change to a new tip.

With the tip filled, re-press the timer bypass button and the dashes will be replaced by the dispense time previously set. (Fig. 2)

Take the Dot Test sheet and put the tip on a 1/4" circle, holding the barrel as shown. Press the foot pedal. Check the dot size. Make several more similar dots and note the size consistency.

## Changing Deposit Size, Drawing Stripes

The dot size is determined by the tip diameter, the output air pressure setting and the pulse time. For large dots, use a large tip, higher pressure and more time. Normally, you want to use as short a time pulse as possible. To increase the dot size, slightly increase output air pressure, or increase tip size, or both.

To make stripes, press the timer bypass button . Dashes replace the time indication. With the tip in contact with the test sheet, press and hold down the foot pedal while making a bead or stripe.

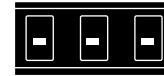

(Fig. 1)



(Fig. 2)

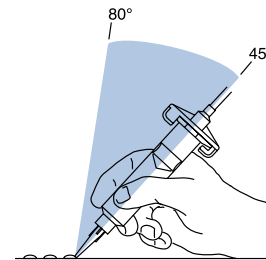



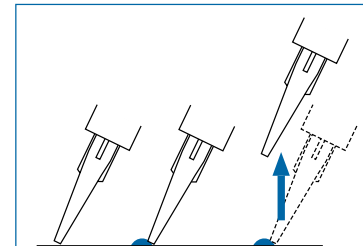

Correct angle for consistent deposits.





Remember - always bring the tip into contact with the work surface at the illustrated angle. After the tip is in position, press the foot pedal. Release pedal and remove tip by lifting straight up.

### Green Tip Settings

Test	Pressure	Time	Dot Size
A	30 psi	0 2 5	
B	20 psi	0 2 5	
C	20 psi	0 1 0	
D	15 psi	0 1 0	

### Blue Tip Settings

Test	Pressure	Time	Dot Size
E	30 psi	0 1 5	
F	20 psi	0 1 5	
G	20 psi	0 1 0	



(Fig. 1)

**Dot Tests** - Use the convenient Dot Test sheet included.

#### Dot Test with Green Tapered Tip

First, follow the settings illustrated on the left, and you will get dots about the size shown. Try other times and pressures to see how easy it is to get just the dot size you want.

#### Dot Test with Blue Tapered Tip

These tests show the effect of using a smaller diameter tip.

Replace the green tip with the blue tapered tip. Now, press the timer bypass button  (dashes appear) and press the foot pedal to fill the tip. Then, press the bypass button to restore time last used (0.10). Press the bottom right button to change from a 0 to a 5. Time displayed now shows 0.15. (For Test G, change the time back to 0.10).

### Programming Deposit Size

Press the program button  (top left). This zeros out the display and you will see 000 (Fig. 1). The decimal will not show. Note that the display flashes bright/dim. This flashing indicates you are in the program mode.

Position the tip on the largest test circle. Press the foot pedal and when the test fluid fills the circle, release the foot pedal. Note the time on the flashing display. Press the program button  once. The time remains and the flashing stops.

Position the tip and momentarily press the foot pedal. The displayed time zeros and counts up to and stops at the programmed time. This time will be repeated each time the foot pedal is pressed.

To change dispensing time, either enter the program mode to zero out the display, or change the displayed digits by pressing the buttons below them.



# How to Use the Vacuum Control

## Making Timed Deposits of Watery-thin Fluids

(1500XL, 1500XL-15, 1500XL-CA 1500DV, 1500DV-15)

The vacuum control allows low viscosity liquids, even water, to be consistently dispensed without dripping between cycles. The vacuum exerts a negative pressure on the liquid in the barrel and prevents dripping.

For these tests, you will use the test barrel with the clear fluid.

1. While holding the barrel upright in one hand, remove the orange end cap and insert the blue LV Barrier.<sup>™</sup> Allow an air gap as shown.
2. Attach the barrel to the 10cc adapter. Snap the safety clip tightly closed to prevent any dripping or bubbling. Remove the tip cap and attach the 25 gage (red) tip.
3. Set air pressure at 5 psi, and the time at 0.14 (*Fig. 1*).
4. Press the timer bypass button  (dashes appear).
5. With the barrel pointing downward over a container, unsnap the safety clip. Then press the foot pedal to fill the tip.
6. If a drop begins to form at the end of the tip, slowly turn the vacuum control knob counterclockwise to stop the drop from growing. Wipe the tip and adjust vacuum as necessary. Normally, only 1 to 2 psi of vacuum pressure is necessary.
7. Press the timer bypass button  to return to the preset dispense time (*Fig. 1*).
8. Take the barrel and place the tip on the test sheet. Press the foot pedal. Check the dot size. Increase or decrease by adjusting pressure or time.

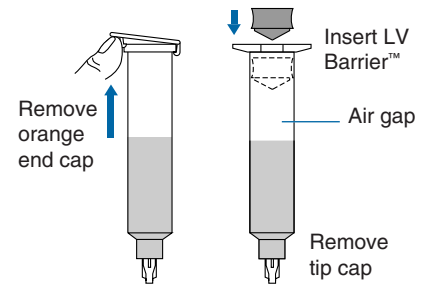

(*Fig. 1*)

### Three things to remember

If you do not use the piston when dispensing thin fluids:

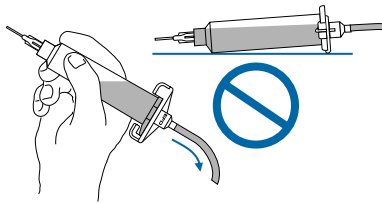

Do not tip the barrel upside down or lay flat. This will cause the liquid to run into the dispenser.

#### Open



When changing tips or attaching a tip cap, snap the safety clip completely closed to prevent any dripping or bubbling.



#### Closed

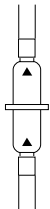

Use an EFD filter trap (#1000FLT-Y). This filter trap will impede the flow should the low viscosity liquid be sucked back towards the dispenser.

If you choose **not** to use the piston, please follow these instructions carefully:

1. While holding the barrel upright in one hand, twist on an orange tip cap. Using the small funnel, fill about 2/3 full with your fluid.
2. Open the safety clip and attach the barrel to the 10cc adapter.
3. Close the safety clip as tight as possible.
4. Increase vacuum by turning vacuum control knob counterclockwise and set to 1.5 on the vacuum pressure gauge.
5. Then, without tipping the barrel upside down, remove the tip cap and attach the 25 gage (red) tip.
6. Open the safety clip. Your material may begin to bubble. Reduce vacuum by turning vacuum control knob clockwise.
7. If a drop begins to form at the end of the tip, slowly turn the vacuum control knob counterclockwise to stop the drop from growing. Wipe the tip and adjust vacuum as necessary.

Now the fluid is in proper balance. It does not bubble or drip.

Repeat tests as before, keeping the air pressure low and adjusting the time for different deposit sizes. Contact EFD if you have any questions.



**US & Canada, call 800-556-3484.**

In Mexico, call 001-800-556-3484.

In the UK, ring free 0800 585733.

## IMPORTANT

Regardless of the fluid viscosity, using the correct EFD piston will give you better results. White SmoothFlow™ piston for most fluids, blue LV Barrier™ for watery-thin fluids and orange flat wall piston for thick, stringy fluids. See pages 24 - 25 for a complete description of how EFD pistons work and the benefits they can bring to your operation.



# Advanced Dispensing System

If you dispense thick fluids, several problems may occur. First, the repetitive air cycles can bore tunnels through non-leveling fluids, causing spitting and inconsistent deposits. Second, thick fluids contain trapped air that leads to drooling and oozing.

**These problems are eliminated by using the SmoothFlow™ piston.** That's because the white pistons prevent tunneling by providing a barrier to the pulsed-air cycles, and prevent oozing by responding to the pressure of trapped air with a slight suck-back movement after the dispense cycle.

The white piston is used for most fluids.

However, if you are applying RTV silicone and find that the piston bounces and causes stringing, switch to the orange, flat wall piston.

The SmoothFlow™ pistons make barrel filling easier, too. As you load the fluid in, air is trapped in the bottom and throughout the fluid. Simply insert a SmoothFlow™ piston and gently press down on the fluid as far as possible. This action forces out most of the air and results in consistent deposits.

## For Thick Fluids

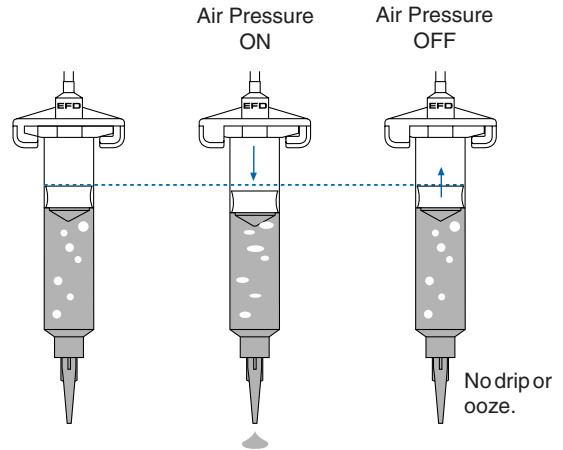

If you use low to medium viscosity fluids, the white SmoothFlow™ piston has several advantages.

First, vacuum adjustment is much less sensitive. Second, the piston prevents fumes from the fluid being exhausted into the work environment. Third, the piston prevents fluid backflow into the dispenser if the barrel is inadvertently turned upside down. Fourth, using the piston makes it easy and safe to change tips without dripping.

**Note:** If you use watery-thin fluids such as solvents, cyanoacrylates and anaerobics, specify the ULTRA System™ with the blue LV Barrier™. Available in 3cc and 10cc sizes.

## For Cyanoacrylates or Watery-thin Fluids

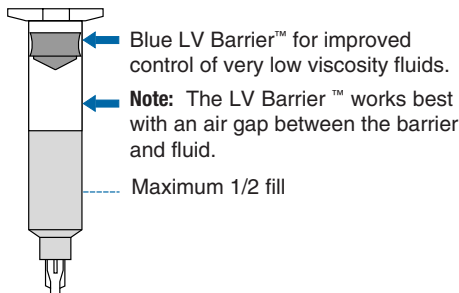

## For Thin Fluids

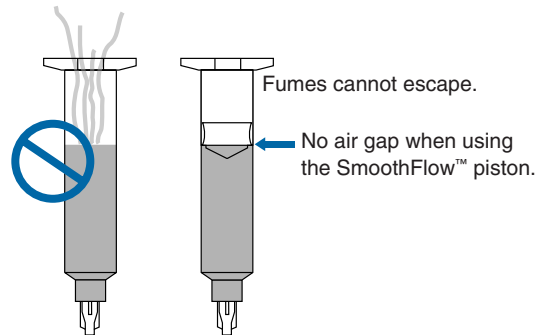
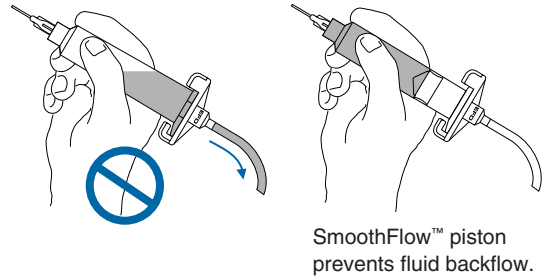

**Note:** If you choose not to use a piston, please refer to page 23 for instructions.

# Loading the Barrel Reservoirs

**Caution:** Do not completely fill barrels. The optimum fill is a maximum 2/3 of the barrel capacity and 1/2 of the barrel capacity when using the LV Barrier™.

If the fluid you are dispensing is pourable, take the barrel, twist on a tip cap and pour your fluid in. If appropriate, insert the SmoothFlow™ piston (see page 24). Carefully press the piston down until it contacts the fluid. The barrel is now ready for use.

If you are dispensing solvents, cyanoacrylates or anaerobics, use the LV Barrier™. Place barrier in the top of the barrel reservoir. Allow air between barrier and fluid. Do not contact the barrier to the fluid.

If your fluid is thick or non-leveling, you can spoon it into the barrel with a spatula. Or, if the fluid comes packed in a 1/10 gallon cartridge, try loading the barrel with a caulking gun. Then press in the SmoothFlow™ piston to move the fluid to the bottom of the barrel and to remove trapped air.

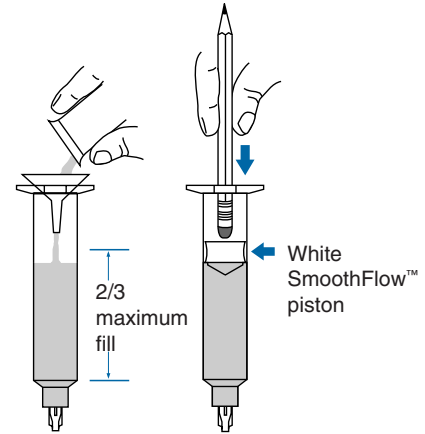

Fill procedure for pourable fluids

Fill procedure for thick fluids (shown: caulking gun)

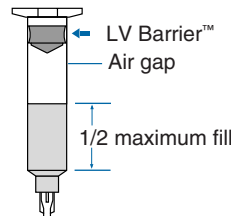
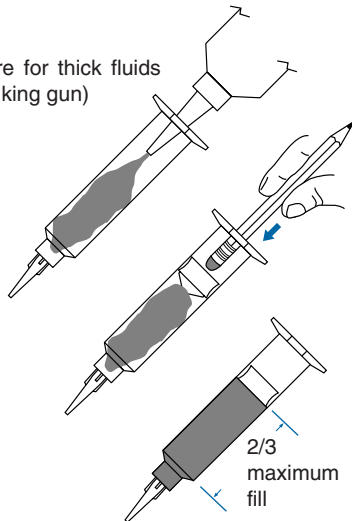

Fill procedure for cyanoacrylates or watery-thin fluids

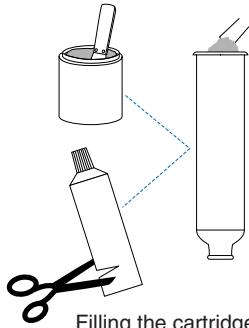

Filling the cartridge for the barrel loader

EFD offers productive alternatives to traditional barrel loading methods. Here are a few suggestions that can help keep your work area clean, save time and reduce the chance of entrapped air in the fluid.

1. You could use the EFD #920BL Barrel Loader. Pack the fluid into the 12 ounce cartridge as shown. Then place the prefilled cartridge into the barrel loader. Using air pressure, the barrel loader fills the barrel (with piston) from the bottom up.  
  
If the fluid comes packed in a 1/10 gallon (300 ml.) caulking type cartridge, use the EFD #940BL Barrel Loader.
2. For fast, accurate volumetric filling, the 8000BF Barrel Filling Station can be used with any pressure reservoir or cartridge. Recommended for high production barrel filling.
3. If you receive frozen epoxies or other fluids in medical type syringes with a manual plunger, request our luer-to-luer fitting #2160 to transfer the material.

Please call an EFD Product Specialist for additional assistance.

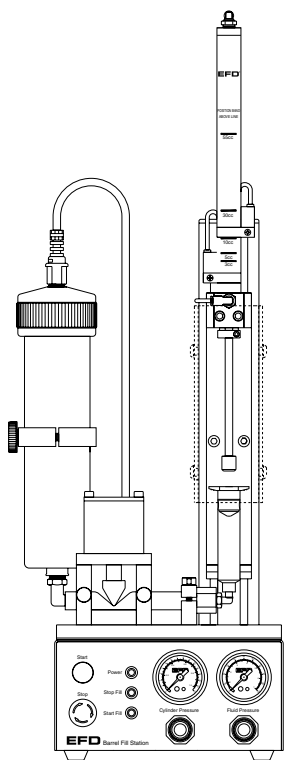

EFD #8000BF Barrel Filling Station

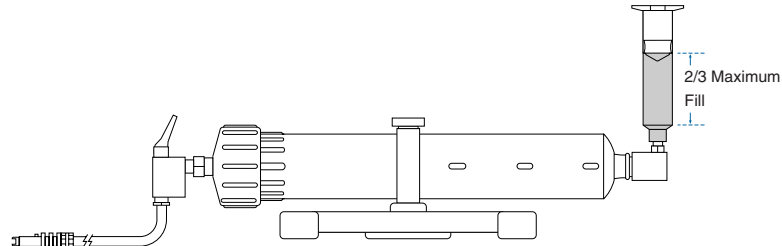

EFD #920BL Barrel Loader  
 (Specify #940BL for prefilled 1/10 gal. caulking tubes)

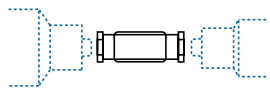

#2160 Luer-to-luer fitting

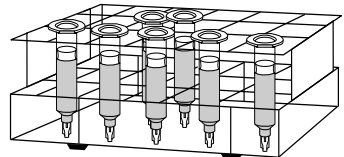

Barrel Rack  
 #905BR for 3cc & 5cc barrels  
 #910BR for 10cc, 30cc and 55cc barrels

# Schematics and Parts

Models 1500XL, 1500XL-15, 1500XL-CA

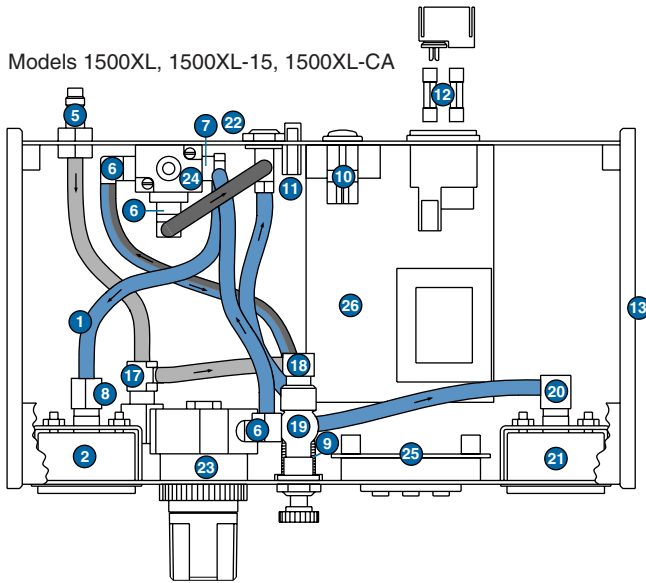

Model 1500D

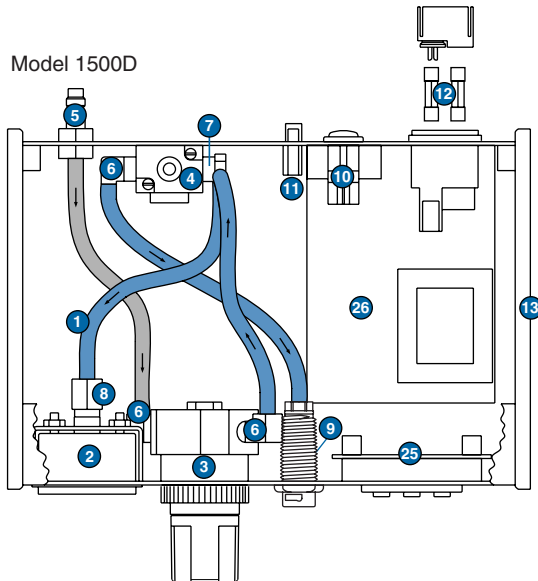

## 1500XL, 1500XL-15, 1500XL-CA, 1500D Replacement Parts List

- |                 |   |
|-----------------|---|
| 1. 2024-160     | 1/4" OD x .160" ID tubing               |
| 2. 2001B        | Gauge 0 to 15 psi (0 to 1.0 bar)        |
| 2001C           | Gauge 0 to 100 psi (0 to 6.9 bar)       |
| 3. 2-2002-1500D | 1500D regulator assembly                |
| 4. 2-2003-24D   | 1500D solenoid assembly                 |
| 5. 2081A        | Male mini air coupler-panel mount       |
| 6. 2087         | Fitting 1/8 NPTM x 1/4 barb elbow brass |
| 7. 2086         | Fitting 1/8 NPTM x 1/4 barb 90° brass   |
| 8. 2036         | Fitting 1/8 NPTF x 1/4 barb brass       |
| 9. 2004B        | Female quick-connect, black             |
| 10. 7109        | Power switch                            |
| 11. 2-2017-1500 | Foot pedal receptacle assembly          |
| 12. 7111        | Fuse .125A                              |
| 13. 2019        | Dispenser end panel                     |
| 14. 2002SCR     | Replacement screen for regulator*       |
| 15. 2009-A24    | Input cord, detachable*                 |
| 16. 2015A       | Foot pedal assembly*                    |
| 17. 2178        | Fitting 1/8 NPTM x 1/4 barb elbow brass |
| 18. 2084        | Air restrictor                          |
| 19. 2-2176-1500 | Barrel vacuum control                   |
| 20. 2088        | Fitting 1/8 NPTF x 1/4 barb brass       |
| 21. 2001B       | Gauge 0 to 15 psi (0 to 1.0 bar)        |
| 22. 2170        | Vacuum transducer                       |
| 23. 2-2002-1500 | 0 to 100 psi (0 to 6.9 bar) regulator   |
| 2-2002A-1500    | 0 to 15 psi (0 to 1.0 bar) regulator    |
| 24. 2-2003-24XL | 1500XL solenoid assembly                |
| 25. 2-2006DB-D  | Display board assembly                  |
| 26. 2-2006PS-D  | Power supply board assembly             |

\* Not Shown

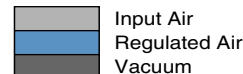

# Schematic and Parts

## 1500DV, 1500DV-15 Replacement Parts List

- |     |                             |   |
|-----|-----------------------------|---|
| 1.  | 2024-160                    | 1/4" OD x .160" ID tubing   |
| 2.  | 2001B<br>2001C              | Gauge 0 to 15 psi (0 to 1.0 bar)<br>Gauge 0 to 100 psi (0 to 6.9 bar)         |
| 3.  | 2-2003-24XL                 | 1500XL solenoid assembly  |
| 4.  | 2-2003-15DV                 | Pickup solenoid assembly  |
| 5.  | 2-2002-15DV<br>2-2002A-15DV | 0 to 100 psi (0 to 6.9 bar) regulator<br>0 to 15 psi (0 to 1.0 bar) regulator |
| 6.  | 2081A                       | Male mini air coupler-panel mount   |
| 7.  | 2087                        | Fitting 1/8 NPTM x 1/4 barb elbow brass                                       |
| 8.  | 2086                        | Fitting 1/8 NPTM x 1/4 barb 90° brass   |
| 9.  | 2085                        | Fitting 1/8 NPTM x 1/4 barb elbow, low profile                                |
| 10. | 2036                        | Fitting 1/8 NPTF x 1/4 barb brass   |
| 11. | 2004B                       | Female quick-connect, black   |
| 12. | 7109                        | Power switch  |
| 13. | 2-2017-15DV                 | Foot pedal receptacle assembly  |
| 14. | 7111                        | Fuse .125A  |
| 15. | 2019                        | Dispenser end panel   |
| 16. | 2002SCR                     | Replacement screen for regulator*   |
| 17. | 2009-A24                    | Input cord, detachable*   |
| 18. | 2-2015F                     | Dual foot pedal assembly*   |
| 19. | 2178                        | Fitting 1/8 NPTM x 1/4 barb elbow brass                                       |
| 20. | 2084                        | Air restrictor  |
| 21. | 2-2176-15DV                 | Barrel vacuum control   |
| 22. | 2-2176-15PU                 | Pickup vacuum control   |
| 23. | 2170                        | Vacuum transducer   |
| 24. | 2032                        | Fitting 1/8 NPTM x 1/4 barb brass   |
| 25. | 2-2006DB-D                  | Display board assembly  |
| 26. | 2-2006PS-D                  | Power supply board assembly   |
| 27. | 2-2017-1500                 | Foot pedal receptacle assembly  |

\* Not Shown

Models 1500DV, 1500DV-15

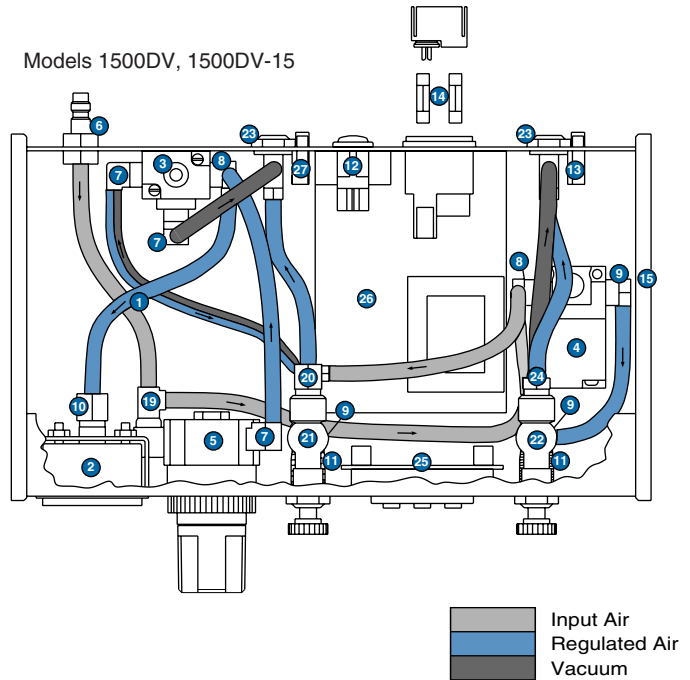

# How the 1500 Series Dispensers Work

With the air connected and the power on, here's what happens when you press the foot pedal.

- (1) The digital solid-state timer is energized and begins dispense cycle countdown.
- (2) The timer opens a solenoid and closes the vacuum pressure for all 1500 Series dispensers except the 1500D, allowing preset air pressure to flow to the barrel reservoir.
- (3) The air pressure pushes the liquid out the dispensing tip.
- (4) At the end of the preset time, the timer shuts off, closing the solenoid and exhausting the air in the barrel.

**Note:** For all 1500 Series dispensers except the 1500D, the vacuum is created by air pressure bleeding through the vacuum transducer. The amount of vacuum is controlled by a vacuum control.

This completes the pulse cycle.

When the timer bypass button is pressed and the display shows dashes, the microprocessor switches to direct solenoid control by the foot pedal. As long as the foot pedal is pressed, the solenoid remains open, providing a bypass flow of liquid for filling or striping.

## Suggestions & Reminders

1. Always use an EFD piston to make barrel loading, dispensing and handling cleaner, safer and more accurate.

**Caution** (for all 1500 Series dispensers except the 1500D): If you dispense watery-thin liquids and do not use LV Barriers™—do not increase vacuum pressure rapidly and do not tip the barrel. Vacuum may pull fluid into the air hose; or when tipped, fluid may run back into the dispenser.

2. Always use new barrels and tips. Carefully dispose of after use. This procedure ensures maximum cleanliness, prevents contamination and provides proper safety.
3. To ensure smooth fluid flow from the tip and to make consistent deposits, always have the tip at about 45° to the work surface.

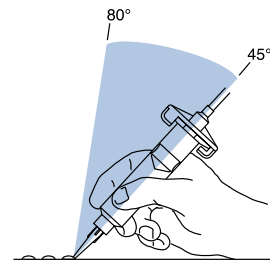

# ULTRA System™ Dispensing Components

For complete selection and technical details, please refer to EFD Catalog and price list.

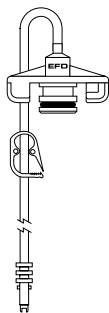

## Barrel adapter assemblies

Molded one-piece, yellow, SnapLok™ adapter head with Buna N O-ring, flexible 5/32" O.D. hose, male quick-connect and safety clip.

size	with 3-ft hose	with 6-ft hose
3cc	1000Y5148	1000Y5148-6
5cc	1000Y5149	1000Y5149-6
10cc	1000Y5150	1000Y5150-6
30cc/55cc	1000Y5152	1000Y5152-6

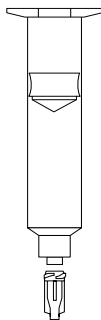

## Barrels/pistons

Each box contains the same quantity of barrels and pistons.

Thin to thick fluids (white SmoothFlow™ piston).

size	UV-block		opaque black	sets/box
	clear	amber		
3cc	5109CP-B	5109AP-B	5109UP-B	50
5cc	5110CP-B	5110AP-B	5110UP-B	40
10cc	5111CP-B	5111AP-B	5111UP-B	30
30cc	5112CP-B	5112AP-B	5112UP-B	20
55cc	5113CP-B	5113AP-B	n/a	15

Cyanoacrylates and watery-thin fluids (blue LV Barrier™)

size	clear barrel, LV Barrier™ & tip cap	sets/box
3cc	5109LV-B	50
10cc	5111LV-B	30



## Smooth-flow tapered tips

Molded polyethylene with UV block. Packaged (50) tips per see-through box for easy part identification.

gage	ID	tapered	color
14	.063"	5114TT-B	olive
16	.047"	5116TT-B	grey
18	.033"	5118TT-B	green
20	.023"	5120TT-B	pink
22	.016"	5122TT-B	blue
25	.010"	5125TT-B	red

## General purpose precision tips

All EFD dispensing tips incorporate the unique SafetyLok™ color-coded polypropylene hubs. Conveniently packaged (50) tips per see-through box for easy part identification.

gage	ID	1/2" length	hub color
14	.061"	5114-B	olive
15	.054"	5115-B	amber
18	.033"	5118-B	green
20	.024"	5120-B	pink
21	.020"	5121-B	purple
22	.016"	5122-B	blue
23	.013"	5123-B	orange
25	.010"	5125-B	red
27	.008"	5127-B	clear
30	.006"	5130-B	lavender



## Useful accessories

**#2000F755:** Five micron filter regulator provides proper air filtering for all dispensers.

Order if you do not have dry, clean, filtered factory air supply.



2000F755

**#2000F756:** Five micron filter regulator with coalescing filter.

Removes liquid aerosols from air supply for cyanoacrylate applications. (Supplied with 1500XL-CA dispenser.)



2000F756

**#7300A:** Barrel stand, fully adjustable three axes



7300A

**#DS1400:**

DispenStand™ holds dispenser vertically.

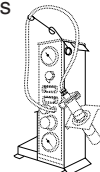

DS1400

**#DS1200:**

Horizontal stand tilts dispenser at a 14° angle for convenient viewing and operation.