



## SPECIFICATIONS

# ROOTS™ RAM™-DPJ WHISPAIR™ High-Pressure Rotary Positive Blowers

Frame 406J DPJ

RAM™ stands for Reliability, Availability and Maintainability. Today, more than ever, ROOTS is committed to supplying our customers with reliable products manufactured with state-of-the-art CNC machine tools. Production and inventory are being scheduled and controlled to ensure these units will be available when you need them. Design improvements such as repositionable rugged steel mounting feet and die-cast aluminum drive end covers and gear covers help to reduce installation costs and make normal maintenance easier.

### BASIC GAS BLOWER DESCRIPTION

The ROOTS™ RAM™-DPJ WHISPAIR™ rotary blower has an exclusive discharge jet plenum design which allows cool, pressurized system air to flow into the cylinder. This unique design permits operation at high pressure levels with a single stage unit.

The RAM high pressure blower is designed for continuous operation at discharge pressures up to 30 psig. It has no valves, vanes or Teflon rings. Clean, dry discharge air or gas provides usable heat for your process.

The basic model is designed using integral-shaft ductile iron impellers with an involute profile. The casing and headplates are grey iron, while the drive and cover and gear cover are die cast aluminum. Carburized and ground alloy steel spur timing gears are taper mounted on the shafts, secured with a locknut. Cylindrical roller bearing are splash lubricated at both the gear end and drive end.

Piston rings reduce air leakage through the headplate bores and lip-type oil seals prevent lubricants from entering the air chamber. Mechanical seals are available upon request.

### WARRANTY PERIOD

Twelve (12) months from date of original unit start-up or 18 months from date of original shipment, whichever occurs first.

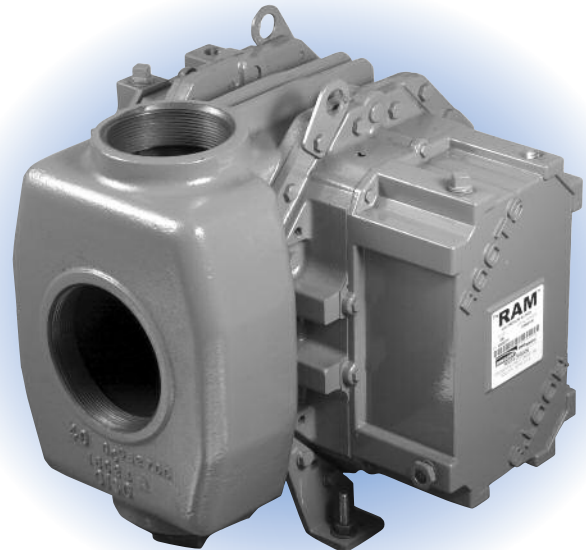

### DESIGN AND CONSTRUCTION FEATURES

1. Single stage operation to 30 psig
2. No valves, vanes or Teflon rings to wear
3. Alloy steel timing gears
4. Cylindrical roller bearings
5. Piston ring air seals
6. Lip-type oil seals, (optional mechanical seal)
7. Splash oil lubrication
8. Horizontal and vertical configurations available

### OPERATING PRINCIPLE

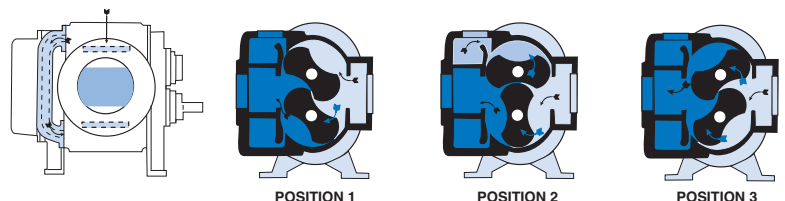

**Position 1:** Incoming air is trapped between the impellers. Simultaneously, pressurized air is being discharged. **Position 2:** As the upper impeller passes the jet plenum, cooled, pressurized air flows into the space between the impeller and cylinder. This cools the trapped air, helps control thermal growth and allows higher discharge pressures. **Position 3:** The trapped air is then moved into the discharge flange (left). Backflow is reduced, resulting in lower operating noise level and reduced shock loading on the impellers.

## PERFORMANCE TABLE

FRAME SIZE	SPEED RPM	15" PSI		20" PSI		25" PSI		30" PSI	
		CFM	BHP	CFM	BHP	CFM	BHP	CFM	BHP
406 DPJ	4000	518	47	494	62	474	76	455	91
	3070	362	35	339	46	319	57	300	69
	2320	237	26	214	35	193	43	195	51
	1750	142	19	119	26	98	32	80	39

Ratings based on inlet air at standard pressure of 14.7 psia, standard temperature of 68°F, and specific gravity of 1.0

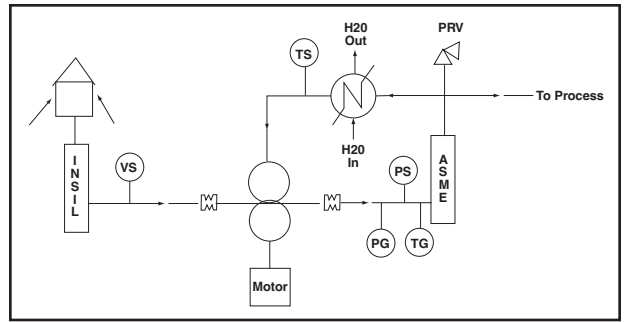

## OUTLINE DRAWING & DIMENSIONAL TABLE

### VERTICAL CONFIGURATION

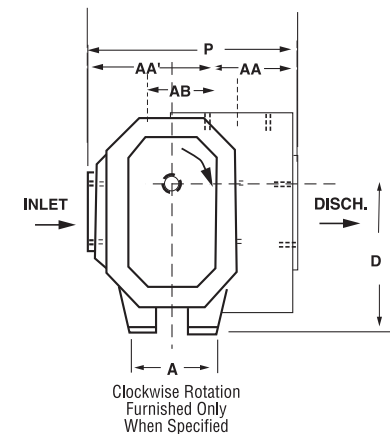
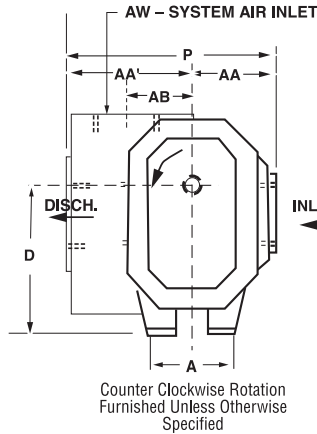
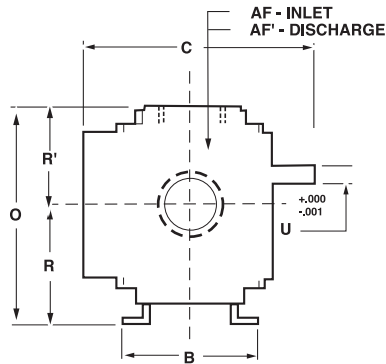

### HORIZONTAL CONFIGURATION

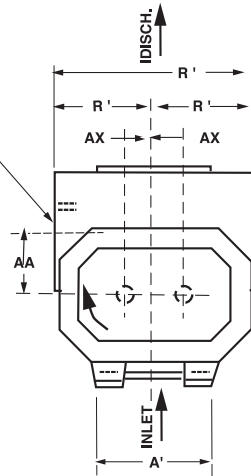
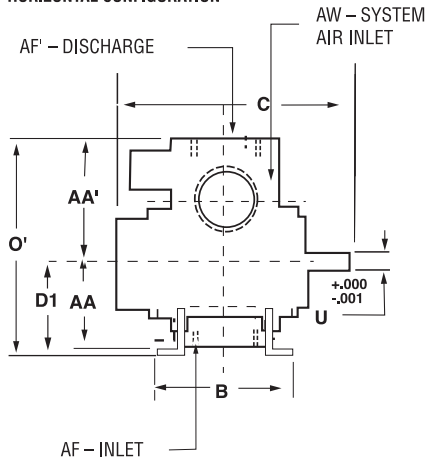

Horizontal Orientation  
Top Discharge Only

FRAME SIZE	A	A'	B	C	Drive Shaft Location		O	O'	P	P'	R	U	Keyway	AA	AA'	AB	AF	AF'	AW	AX	WGT.
					D	D1															
406 DPJ	8.00	11.00	10.75	20.50	11.25	7.50	16.38	18.00	17.75	14.75	9.00	1.500	.375 x .188	7.25	15.25	10.50	4 NPT	5 NPT	4 NPT	2.25	365

### NOTES:

1. All dimensions are in inches. 2. Weights are in pounds, and are approximate.

### Dresser Roots

Houston, Texas Headquarters • U.S. Toll Free Phone: 1-877-363-ROOT(S) (7668) • Direct Phone: +1 832-590-2600  
 Connersville, Indiana Operations • U.S. Toll Free Phone: 1-877-442-7910 • Direct Phone: +1 765-827-9285  
 United Kingdom Operations • Phone: +44 (0) 1695 52600  
 USA/Canada Sales • Phone: +1 773-444-3360  
 Houston, Texas Factory Service • Phone: +1 713-896-4810  
 Mexico City Sales and Factory Service • Phone: +52 55 5889 5811  
 Dubai Sales and Factory Service • Phone: +971 4-8830831  
 Malaysia Sales • Phone: +60 3 2163 0480  
 China Sales • Phone: +86 10 8486 2440  
 Shanghai Factory Service • Phone: +86 21 5858 7638



©2007 Dresser, Inc. all rights reserved. • Printed in the U.S.A. • All information subject to change without notice. • Universal RAI and EasyAir are registered trademarks of Dresser, Inc. • ROOTS, RAM X, and WHISPAIR, are trademarks of Dresser, Inc.

[www.dresser.com/rootsblowers](http://www.dresser.com/rootsblowers)